



# CATALOGUE

Cryo Bio System was founded in 1987 and is the human division of IMV Technologies.

Exclusively dedicated to Life Science and Biodiversity, Cryo Bio System strives to provide scientists and physicians with IMV Technologies' expertise in the field of cryopreservation of biological samples, with innovative and High Security products for:

- Biorepositories, epidemiological research
- Blood transfusion haemovigilance
- Cell culture and genetic therapy units
- The pharmaceutical industry
- Assisted Reproductive Technologies
- Genomics and proteomics
- Medico-legal storage
- Military medicine
- Biodiversity (animal and plant-based germplasm conservation)

Cryo Bio System currently operates in over 80 countries through five subsidiaries in the USA, India, Italy, the Netherlands and China, as well as a network of efficient distributors, focusing on product quality and a keeping close to its clients to best meet their requirements.

## Cryo Bio System...

High Security, a unique concept



### Safety

No risk of cross-contamination between samples, the outside environment (LN2) and the operator.



### Biocompatibility

Use of biocompatible, non toxic ionomeric resin, with no plastic agent or by-product.



### Traceability

Color code identification and LN2-proof printed labels/jackets (link with sample, patient's clinical and medical data).



### Optimization

Storage in straws or goblets for space optimization.

# CONTENTS

---

## ■ CONSUMABLES

CBS™ High Security sperm straw with tripartite plug 0.3 and 0.5 ml	6
CBS™ High Security embryo and sperm straw with tripartite plug 0.3 ml	8
CBS™ High Security 2 ml tissue straw	8
PETG sperm straw	9
PETG embryo straw	9
CBS™ High Security Vitrification straw	10
CBS™ High Security Tube	12
LEJA slides	14
Injection, holding and biopsy pipettes	15

## ■ ACCESSORIES

Micro-aspirator	18
Makler® counting chamber	18
Identification rods for CBS™ 0.3 ml straws	19
Identification and obturating rods for PETG straws	19
2D colored inserts	19
BMP 21 and BMP 51 printers	20

## ■ STORAGE

Visotubes and goblets	24
Canisters	26
Identification rods for visotubes	27
Insulated transport box	27

## ■ EQUIPMENT

Nano-Digitcool	30
Digitcool controlled-rate freezers	31
Craft™ pump	32
SYMS	32
SYMS III	33
SYSO	34
PACE	35
MAPI	36
DIVA	37
Integral HSV	38



## CONSUMABLES

CBS™ High Security sperm straw with tripartite plug 0.3 and 0.5 ml  
CBS™ High Security embryo and sperm straw with tripartite plug 0.3 ml  
CBS™ High Security 2 ml tissue straw  
PETG sperm straw  
PETG embryo straw  
CBS™ High Security Vitrification straw  
CBS™ High Security Tube  
LEJA slides  
Injection, holding and biopsy pipettes

# CBS™ High Security sperm straw with tripartite plug 0.3 and 0.5 ml

CE marked according to directive 93/42/CE  
FDA registration

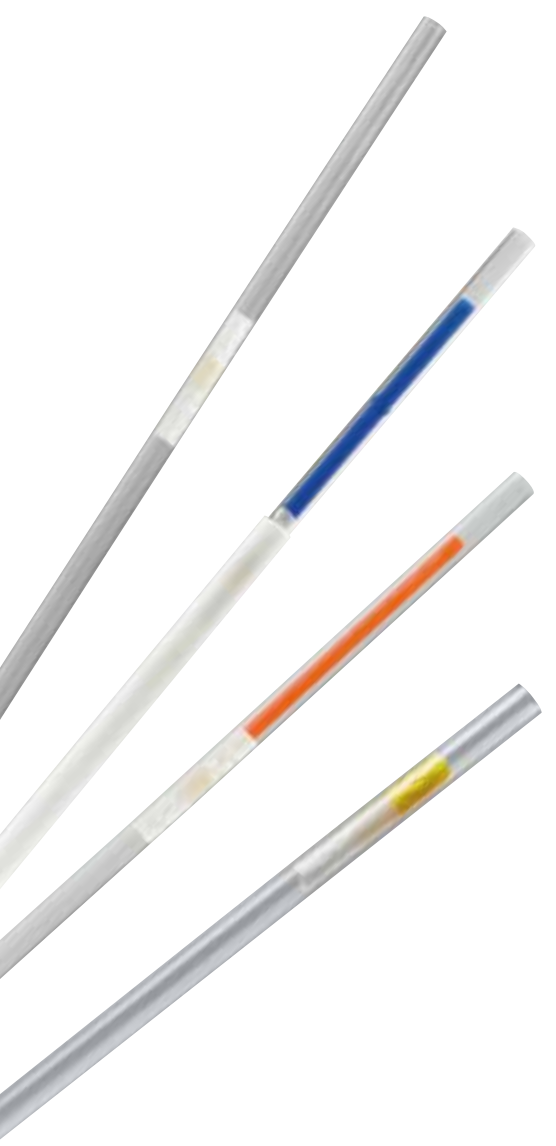

## DESCRIPTION

Human sperm freezing and cryopreservation. With their distinctive characteristics, filling and sealing methods, CBS™ High Security straws are designed for cryopreservation of human biological samples, guaranteeing perfect tightness, specifically in liquid nitrogen. Manufactured from biocompatible materials, they are suited to Assisted Reproductive Technologies, and more specifically for embryo and sperm cryopreservation. The CBS™ High Security straw is a clear flexible tube made of ionomeric resin.

## TECHNICAL CHARACTERISTICS

Length: 133 mm  
Internal diameter: 2.5 mm  
*Sterilization by irradiation.*



024856	Box of 100 sterile clear filling nozzles	100
014175	Permanent black markers	2
016730	Sterile connection tubing for syringe (individually packed)	10
016731	Sterile connection tubing for syringe (packed in units of 5)	5

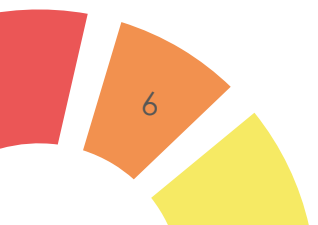

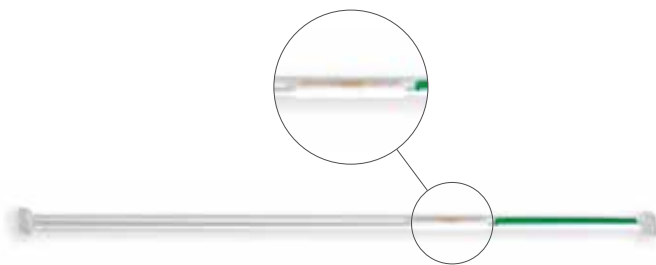

**CBS™ 0.3 ml model**

This straw comprises two separate parts separated by a white plug. The first part contains semen and has a capacity of 0.3 ml. The second part accommodates the colored identification rod and is used for holding when handling liquid nitrogen.

- 010287 CBS™ High Security 0.3 ml sperm straw white plug 20
- 010288 CBS™ High Security 0.3 ml sperm straw white plug 100

**For MAPI and PACE**

- CBS™ High Security 0.3 ml sperm straw colored identification rod and white jacket 75

- Red 017797 ●
- White 017798 ○
- Yellow 017799 ●
- Blue 017800 ●
- Green 017801 ●
- Violet 017802 ●

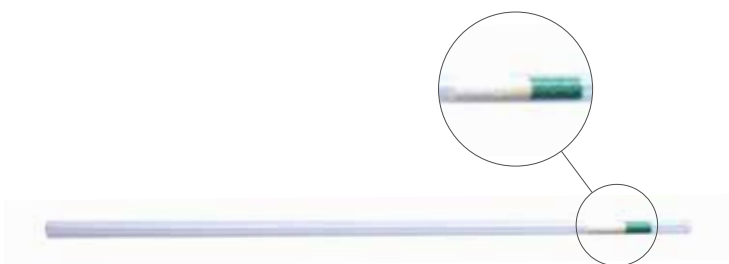

**CBS™ 0.5 ml model**

This model features the same technical specifications as the 0.3 ml straw, except that it has a capacity of 0.5 ml and the external surface of the plug is colored.

- 014651 CBS™ High Security 0.5 ml sperm straw white plug 20
- 014650 CBS™ High Security 0.5 ml sperm straw white plug 100

- CBS™ High Security 0.5 ml sperm straw with colored cotton plug 100

- Red 016584 ●
- Yellow 016611 ●
- Green 016612 ●
- Blue 016613 ●
- Orange 016614 ●
- Grey 016615 ●

**30 mm weighted identification rods for 0.3 ml straws 10**

- Yellow 019021 ●
- Green 019022 ●
- Blue 019023 ●
- Orange 019024 ●
- White 019025 ○
- Red 019026 ●

**Outer identification jacket 50**

- Red 010272 ●
- White 010273 ○
- Orange 010274 ●
- Green 010275 ●
- Blue 010276 ●
- Yellow 010277 ●
- Clear 014939 ○

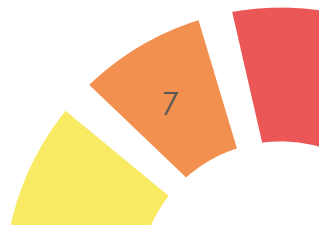



# CBS™ High Security embryo and sperm straw with tripartite plug 0.3 ml

CE marked  
FDA 510(k) premarket notification clearance for the USA # K002595

**025292 CBS™ High Security embryo and sperm straw with tripartite plug 0.3 ml**

**20**

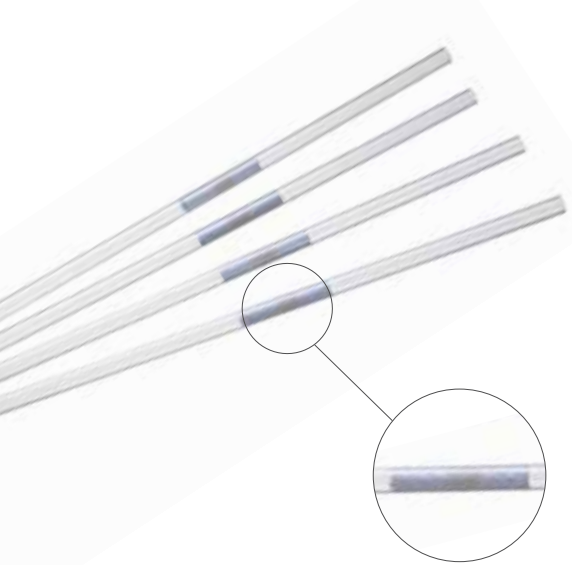

## DESCRIPTION

The CBS™ High Security embryo and sperm straw with braided plug is specifically designed for long-term cryopreservation of human biological samples, including liquid nitrogen. Made of biocompatible materials, it is suited to Assisted Reproduction procedures, and more specifically to embryo and sperm cryopreservation. *Single packaging. Pack of 5 blisters of 4 units.*

## TECHNICAL CHARACTERISTICS

Length: 133 mm  
Internal diameter: 2.5 mm.  
*Sterilization by irradiation.*

## 30 mm weighted identification rods

**10**

Yellow	Green	Blue	Orange	White	Red
019021	019022	019023	019024	019025	019026

## 024856 Box of sterile clear filling nozzles

**100**



The CBS™ filling nozzle ensures a leak-proof environment as it fully isolates the sealing zone from any contact with fluid as the biological sample is drawn in.

# CBS™ High Security 2 ml tissue straw

CE marked

**018960 CBS™ High Security 2 ml tissue straw**

**20**



## DESCRIPTION

Cryopreservation of tissue fragments. CBS™ High Security 2 ml tissue straws are identified with labels with liquid nitrogen-proof ink and sticker. *Single packaging. Pack of 5 blisters of 4 units.*

## TECHNICAL CHARACTERISTICS

*Sterilization by irradiation.*



## PETG sperm straw

010261	Transparent PETG 0.25 ml sperm straw	100
014550	Transparent PETG 0.5 ml sperm straw	100
007342	Yellow sterile (13 mm) sealing and identification rods	20



### DESCRIPTION

Freezing and storing human sperm PETG sperm straws are clear flexible straws made of a copolymer.

- The section which holds semen has a volume of 0.21 ml or 0.47 ml.
- The other section is used as an aspiration zone during filling.

### TECHNICAL CHARACTERISTICS

- 0.25 ml straw  
Length: 133 mm  
Internal diameter: 1.6 mm
  - 0.5 ml straw  
Length: 133 mm  
Internal diameter: 2.5 mm
- Sterilization by irradiation.*

## PETG embryo straw

006433	5 blister packs of 20 rigid embryo straws - 91 mm
006578	5 blister packs of 20 rigid embryo straws - 133 mm
014102	5 blister packs of 20 flexible embryo straws - 91 mm
014103	5 blisters packs of 20 flexible embryo straws - 133 mm

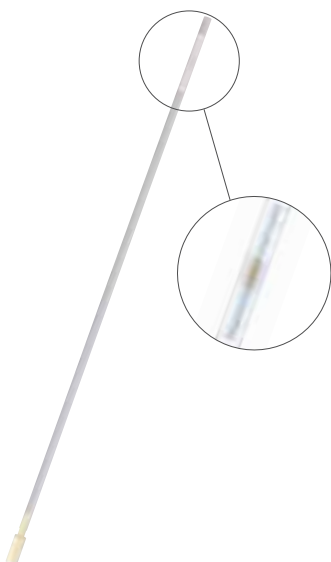

### DESCRIPTION

PETG embryo straws are flexible or rigid clear tubes made of copolymer. The PETG embryo straws are closed at one end by a double-woven cotton plug, enclosing a dose of powder that polymerizes when in contact with liquid.

*Blisters of 4 x 5 units.*

### TECHNICAL CHARACTERISTICS

- 0.15 ml for 91 mm long straws
  - 0.25 ml for 133 mm long straws
- The internal diameter is 1.6 mm for both models.  
*Sterilization by irradiation.*

The 91 mm straws are closed with 42 mm identification rods and the 133 mm straws are closed with 13 mm identification and sealing rods (p.19)

# CBS™ High Security Vitrification straw

CE marked  
FDA 510(k) premarket notification clearance for the USA  
# K092398 for 4-8 cell and blastocyst stage embryos



## DESCRIPTION

Vitrification of embryos

The kit is comprised of 3 parts:

- a transparent High Security Vitrification ionomeric resin straw;
- a capillary tube with a transparent gutter and co-injected colored handling rod;
- a blue insertion device.

*Individually packaged. Blister pack of 4 kits.*

## TECHNICAL CHARACTERISTICS

*Sterilization by irradiation.*



## Blister of 4 CBS™ High Security Vitrification straws

Red 025246 ● White 025247 ○ Yellow 025248 ● Pink 025249 ● Blue 025250 ● Green 025251 ●

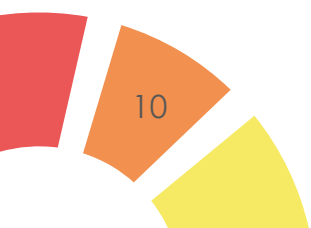

10

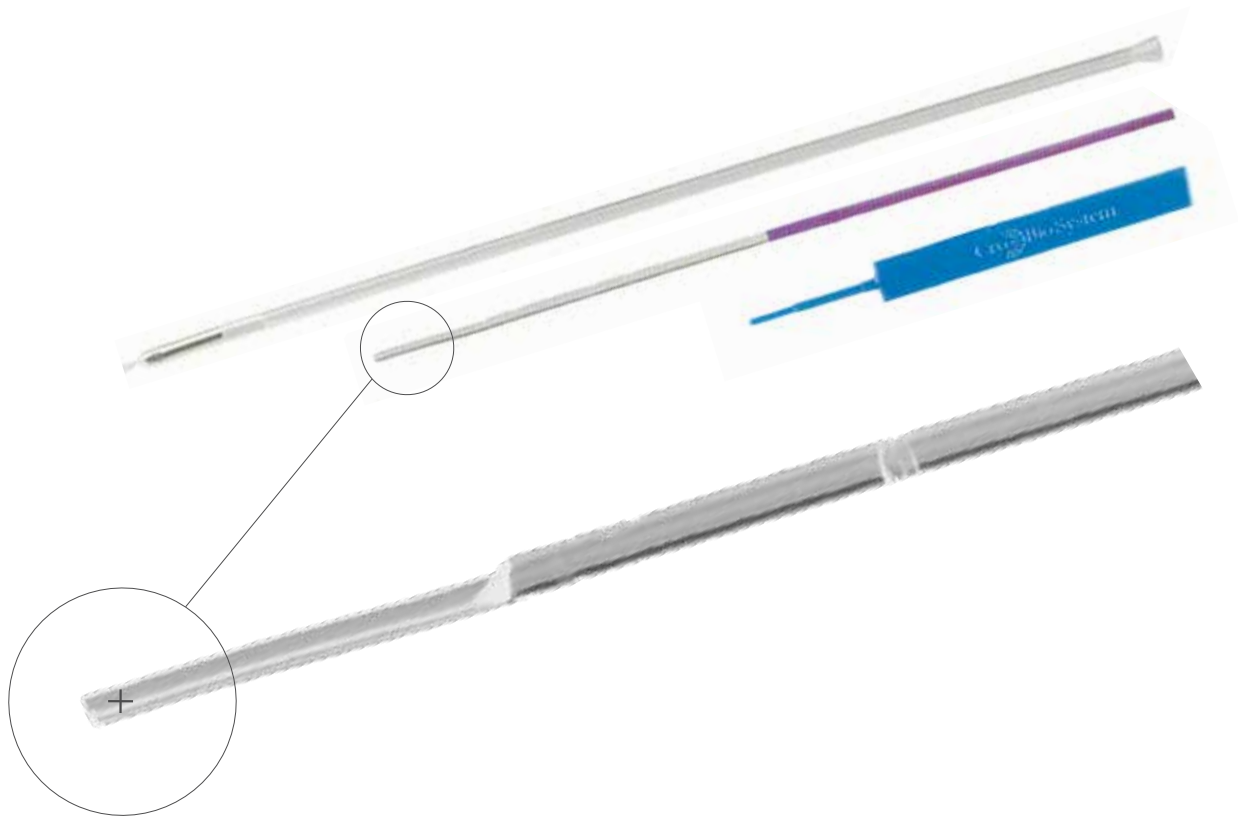

- 027636 Box of 5 opening devices for CBS™ High Security Vitrification straw
- 027172 Opening set (holder + device) for CBS™ High Security Vitrification straw



**DESCRIPTION**

The opening device for CBS™ High Security Vitrification straws has been designed exclusively to open CBS™ High Security Vitrification straws. It is an ambidextrous device. It can be held either directly in the hand or using a “holder” (an accessory designed to keep the user further from the liquid nitrogen).

**027807 Integral HSV Vitrification Unit**



**DESCRIPTION**

The INTEGRAL HSV vitrification unit is designed for vitrification, packaging and opening of CBS™ High Security Vitrification straws in the following applications:

- Reproductive Biology Laboratories

**For more information: p.38**

# CBS™ High Security Tube

COMPLIANCE WITH INTERNATIONAL STANDARDS

Compliant with CE standards according to the European Medical Devices Directive 93/42/CE modified 2007/47/CE (Classe IIa).

**022252 Bag of 20 sterile CBS™ High Security Tubes**

**023722 Bag of 50 sterile CBS™ High Security Tubes**

**022251 Bag of 100 non-sterile CBS™ High Security Tubes**



## DESCRIPTION

The unique fully secured system for storage in liquid nitrogen.

CBS™ High Security tubes are derived from the CBS™ high security concept designed for optimum sample preservation. Made of biocompatible resin, CBS™ tubes eliminate concerns related to cross-contamination and issues induced by storage in liquid nitrogen.

Once sealed with the SYMS III sealer, the CBS™ High Security tube will be placed in storage boxes and in current storage systems.

## TECHNICAL CHARACTERISTICS

Usable working volume: 1.2 mL

Dimensions: 48 mm, Ø 11.8 mm

*Sterilization by irradiation.*



## SCOPE OF APPLICATION

- Preservation of fertility (ovarian and testicular tissue, and sperm) for Assisted Reproductive Technologies
- Biological tissue banks for clinical phase or research
- Blood banks and blood transfusion centers
- Cell and genetic therapy (clinical phase and therapeutic applications)
- Packaging of vaccines and heat-sensitive drugs

## SAFETY

- Full seals eliminate risks of cross-contamination of the sample and its environment
- Validated as leak-proof and shatter-proof in all cryogenic temperatures including temperatures as low as liquid nitrogen phase
- Indestructible under normal conditions of use



### TRACEABILITY OPTIONS

- Colored inserts for simple identification in cryogenic environments
- 2D data matrix coded inserts
- Compatible with cryoresistant labels

### COMPATIBILITY

- Standard racks, boxes (9x9 or 10x10), canes
- Manual or automatic filling systems
- Programmable freezers (URL link: Digitcool line)
- Cryogenic storage conditions for use in:
  - o Liquid nitrogen
  - o Vapor phase
  - o Mechanical freezers

024922 SYSO



### DESCRIPTION

The SYSO opening device can be used under laminar flow and is designed to open CBS™ High Security tubes with a hot wire.

**For more information: p.34**

023836 Autoclavable scissors for CBS™ High Security Tubes



# LEJA slides

## 026853

CE marked  
SC-10-01-04-B  
10 µm 4 wells - 4X25  
2 µl / analysis

## 026854

SC-12-01-C  
12 µm 2 lateral wells - 4X25  
4 µl / analysis

## 026855

CE marked  
SC-20-01-C  
20 µm 2 lateral wells - 4X25  
6 µl / analysis

## 026354

CE marked  
SC-20-01-02-B  
20 µm 2 wells - 4X25  
6 µl / analysis

## 026355

CE marked  
SC-20-01-04-B CE  
20 µm 4 wells - 4X25  
3 µl / analysis

## 026357

CE marked  
SC-100-01-02-A  
100 µm 2 high precision wells - 4X25  
30 µl / analysis

## 026857

CE marked  
SC-100-01-02-B  
100 µm 2 wells - 4X25  
30 µl / analysis



026853



026854



026855

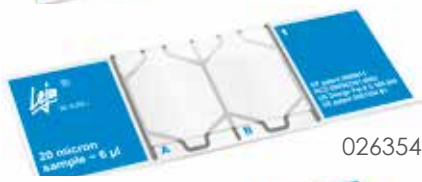

026354



026355



026357 - 026857

## DESCRIPTION

High quality disposable counting chambers for sperm analysis.

Due to their special characteristics, Leja slides will both save time and increase the level of accuracy and precision of sperm analysis.

All slides are covered with a special coating to prevent air bubbles and to prevent the sample from bonding to the chamber surface.

The resin and ink are both non toxic. Leja slides have an excellent low limit of quantification and can handle high sperm concentrations.

This has a direct clinical impact: you will be better prepared to determine the thresholds for the various procedures of Assisted Reproduction Technologies (waiting for natural conception, intrauterine insemination, in-vitro fertilization and intracytoplasmic semen injection) and to decide on the best treatment option for a couple.

The high level of accuracy and precision of the Leja slides will allow your results to be compared with scientific data from other laboratories in regards to the relationship between semen parameters (concentration, motility, viscosity) and fertility.

## TECHNICAL CHARACTERISTICS

Slides with 2 or 4 chambers

Depth: 10, 12, 20 or 100 microns





# Injection, holding and biopsy pipettes

CE marked

Their unique shape and taper provide for smooth movement of its content.  
*Individually packed in boxes of 10 units.*  
*Sterilization by irradiation.*

## INJECTION PIPETTES



<b>022166</b>	<b>Injection pipette – 20° angle</b>	<b>10</b>
<b>022167</b>	<b>Injection pipette – 30° angle</b>	<b>10</b>

### DESCRIPTION

Injection pipettes are used to perform intracytoplasmic sperm injection (ICSI).

## HOLDING PIPETTES



<b>022168</b>	<b>Holding pipette – outer ø 100 µm – 20° angle</b>	<b>10</b>
<b>022169</b>	<b>Holding pipette – outer ø 100 µm – 30° angle</b>	<b>10</b>
<b>022170</b>	<b>Holding pipette – outer ø 120 µm – 20° angle</b>	<b>10</b>
<b>022171</b>	<b>Holding pipette – outer ø 120 µm – 30° angle</b>	<b>10</b>

### DESCRIPTION

Holding pipettes are designed to hold an oocyte or embryo in position during ICSI and other micromanipulation procedures.

## BLASTOMERE BIOPSY PIPETTES



<b>022172</b>	<b>Pipette for blastomere biopsy – 30° angle</b>	<b>10</b>
---------------	--	-----------

### DESCRIPTION

Blastomere biopsy pipettes are designed to remove blastomeres from embryos for preimplantation genetic diagnosis (PGD).

	<b>Angle</b>	<b>Inner diameter</b>	<b>Outer diameter</b>	<b>Tip to angle length</b>
<b>Injection</b>	20° / 30°	4.5-5.0 µm	7 µm	0.55 mm
<b>Holding</b>	20° / 30°	15-20 µm	100-119 µm / 120-130 µm	0.65 mm
<b>Blastomere biopsy</b>	30°	28-32 µm	31-35 µm	0.55 mm

CONSUMABLES



## ACCESSORIES

Micro-aspirator  
Makler® counting chamber  
Identification rods for CBS™ 0.3 ml straws  
Identification and obturating rods for PETG straws  
2D colored inserts  
BMP 21 and BMP 51 printers

# Micro-aspirator

---

014498 Micro-aspirator (comes with two adapters and tubing)



## DESCRIPTION

Manual straw filling.

The micro-aspirator is used to manually fill all straws manufactured by Cryo Bio System without any risk of contamination.

014500 Micro-aspirator adapter and tubing

# Makler<sup>®</sup> counting chamber

---

016261 Makler<sup>®</sup> counting chamber (complete with cover glass and grid)

016262 Spare cover disc with grid



## DESCRIPTION

Quick semen analysis.

Counting chamber and flat disc made of optical glass for sperm count and testing.

Reusable: easy to clean with bleach-free disinfectant.

The 10 micron depth eliminates any blurred area and enables sperm motility.

The specimen is analyzed horizontally. The grid is positioned over the disc. Therefore, there is no need to insert and remove the grid under the microscope lens.

# Identification rods for CBS™ 0.3 ml straws

## Bag of 30 mm weighted identification rods

10

Yellow 019021 ● Green 019022 ● Blue 019023 ● Orange 019024 ● White 019025 ○ Red 019026 ●

- 025292 CBS™ High Security embryo and sperm straw with tripartite plug 0.3 ml
- 024856 Box of 100 Sterile filling nozzle for CBS™ High Security straws

# Identification and obturating rods for PETG straws

## Blister pack of 20 sealing and identification rods (42 mm) for 91 mm PETG straws

Yellow 007437 ● Violet 007438 ● Red 007440 ● Orange 007442 ● Pink 014484 ●  
 Blue 014485 ● Grey 014486 ● Green 014487 ● Royal Blue 014488 ● White 014489 ○

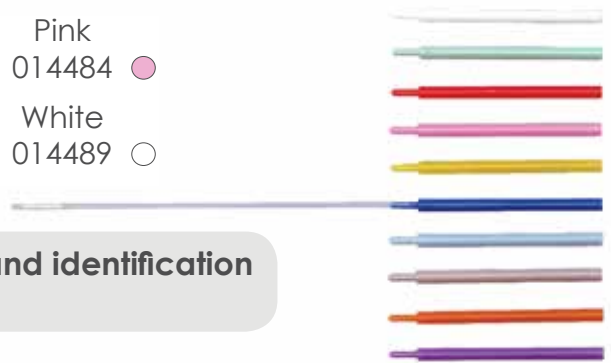

- 007342 Blister pack of 20 sterile yellow sealing and identification rods (13 mm) for 133 mm PETG straws

ACCESSORIES

# 2D colored inserts

## Bag of 500 inserts for CBS™ High Security Tubes

White 024108 ○ Blue 024109 ● Green 024110 ● Yellow 024111 ● Red 024112 ● Pink 024113 ●



- 026733 Bag of 20 sterile white inserts with 2D data for CBS™ High Security Tubes

- 024114 Bag of 100 sterile white inserts with 2D data for CBS™ High Security Tubes

# BMP 21 and BMP 51 printers

---

- 024498 BMP 21 printer
- 025446 BMP 51 printer



BMP 21 PRINTER



BMP 51 PRINTER

## DESCRIPTION

Identification of CBS™ High Security and CBS™ High Security Vitrification straws for BMP 21 and BMP 51. Additional option of CBS™ tube identification with the BMP 51. Brady labels are specially designed for harsh laboratory environments.

## TECHNICAL CHARACTERISTICS

Print method: thermal transfer (lasting, no smearing).  
Multiple line printing.

### BMP 21 PRINTER

L x W x H: 228.6 x 114.3 x 63.5 mm  
Weight: 0.750 kg

### BMP 51 PRINTER

L x W x H: 262 x 91 x 152 mm  
Weight: 1.2 kg

Service temperature: 4°- 49° C  
FCC Class A approved (printer)

## BMP 21 PRINTER

- 024500 220V adapter for BMP 21 printer
- 024499 BMP 21 printer case
- 024501 Polyester ribbon 9.5mm for BMP 21 printer
- 025453 Polyester ribbon 12.7 mm for BMP 21 printer

## BMP 51 PRINTER

- 025450 Self-protected large label for CBS™ tube
- 025451 Self-protected small label for CBS™ tube
- 026433 Polyester ribbon 9.5mm for BMP 51 printer
- 026434 Polyester ribbon 12.7 mm for BMP 51 printer





TRACEABILITY



BIOCOMPATIBILITY



SECURITY



OPTIMIZATION





# STORAGE

Visotubes and goblets  
Canisters  
Identification rods for visotubes  
Insulated transport box

# Visotubes and goblets CBS™



## DESCRIPTION

Freezing of biological samples in liquid nitrogen in straws, sorted by color codes. CBS High Security straws are inserted in visotubes, which are housed in colored goblets prior to being stored in the cryopreservation units. Goblets come in 8 different colors and their sub-compartments (visotubes) come in 12 different colors.

The Daisy goblet holds 12 visotubes and can hold a maximum of 168 CBS High Security 0.3 and 0.5 mL straws.

## TECHNICAL CHARACTERISTICS

Diameter: 65 mm (67 mm with lid)

Goblet height: 117 mm

Total height of the Daisy goblet (with cover): 135 mm

Height of triangular visotubes: 120 mm

Height of round visotubes with 17.5 mm diameter: 133 mm

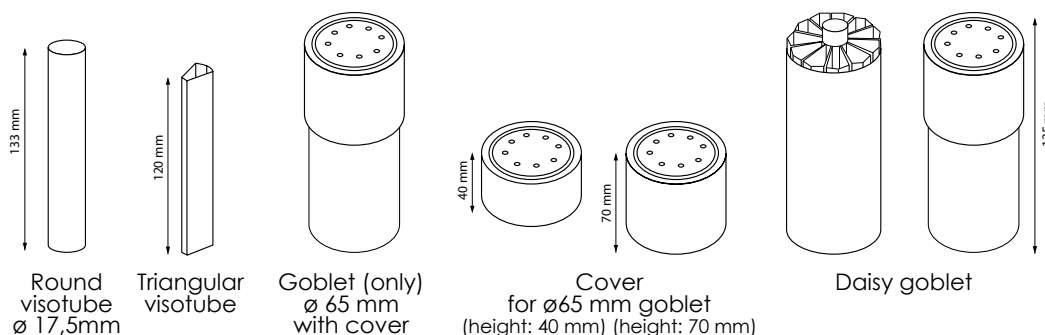

		006924	-	021224	021366	006321	015144	015152
C O L O R S	Transparent	○		021224	021366	006321	015144	015152
	Black	●	018153	-	-	-	-	-
	Brown	●	018147	-	-	-	-	-
	Red	●	018146	021228	-	-	015146	015154
	Green	●	018145	021226	-	-	015147	015155
	Blue	●	018148	021225	-	-	015151	015159
	Grey	●	018144	026948	-	-	018141	018142
	Violet	●	018152	021229	-	-	015150	015158
	Yellow	●	018143	021227	-	-	015148	015156
	Pink	●	018149	-	-	-	-	-
	Orange	●	018150	-	-	-	-	-
	Pistachio	●	018151	026949	-	-	015149	015157
<b>PACKAGING</b>		<b>100</b>	<b>100</b>	<b>10</b>	<b>50</b>	<b>10</b>	<b>1</b>	<b>5</b>
C A P A C I T Y	PETG 0.25 mL straw	55	45	820	-	-	540	540
	PETG 0.5 mL straw	20	20	365	-	-	240	240
	HSV CBS™ High Security straw	20	20	365	-	-	240	240
	High Security CBS™ straw	14	14	225	-	-	168	168

# Visotubes and goblets CBS™



## DESCRIPTION

Freezing and storage of biological materials in straws. Arrangement using color coding of straws prior to storage in liquid nitrogen.

- Standard goblet Ø 35 mm  
Diameter: 35 mm  
Height: 122 mm
- Standard goblet Ø 65 mm  
Diameter: 65 mm  
Height: 117 mm
- Polygonal, hexagonal and round visotubes  
Height: 120 mm

All visotubes are also available in bags of 300 units (in identical colors and diameters).

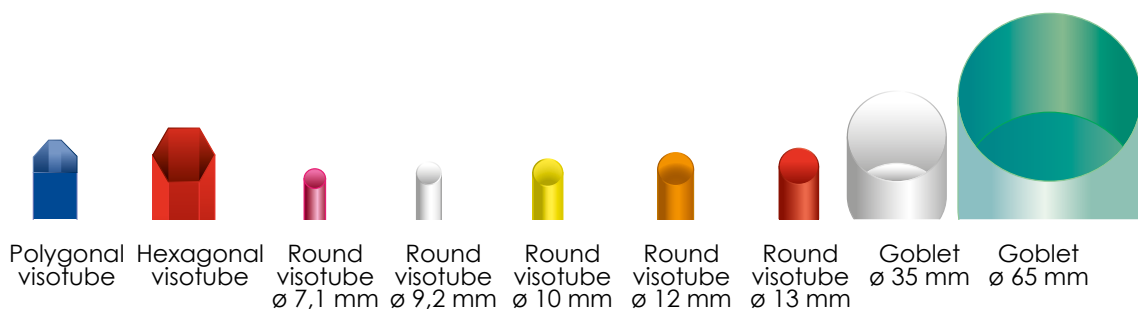

STORAGE

		Polygonal visotube	Hexagonal visotube	Round visotube ø 7,1 mm	Round visotube ø 9,2 mm	Round visotube ø 10 mm	Round visotube ø 12 mm	Round visotube ø 13 mm	Goblet ø 35 mm	Goblet ø 65 mm
COLORS	White ○	020470	020486	020492	020499	020505	020511	020517	020523	024392
	Blue ●	020472	020487	020493	020500	020506	020512	020518	-	006755
	Green ●	020482	020488	020494	020501	020507	020513	020519	-	006754
	Yellow ●	020483	020489	020495	020502	020508	020514	020520	-	006756
	Orange ●	020484	020490	020496	020503	020509	020515	020521	-	-
	Red ●	020485	020491	020497	020504	020510	020516	020522	-	006397
	Violet ●	-	022141	-	-	-	-	-	-	006757
Pistachio ●	-	-	-	-	-	-	-	-	006753	
<b>PACKAGING</b>		10	10	10	10	10	10	10	10	10
CAPACITY	PETG straw 0.25 mL	30	90	7	10	14	22	27	200	820
	PETG straw 0.5 mL	15	36	2	5	5	8	10	94	365
	HSV CBS™ High Security straw	14	36	3	6	6	10	12	-	-
	CBS™ High Security straw	8	22	1	3	4	7	7	75	225
	In a goblet ø 35 mm	4	1	15	10	8	5	5	-	-
In a goblet ø 65 mm	15	7	60	37	31	21	19	-	-	

# Canisters



## DESCRIPTION

Canisters are cylindrical racks for keeping goblets in liquid nitrogen or nitrogen vapors. The goblet and canister storage concept is compatible with all types of nitrogen and electric freezers.

Five canister lengths are available, with a capacity of between 2 and 6 goblets. A colored flag can be placed on the lifter (a bent metal rod to lift the stack of goblets) for quick identification of each canister.

Canisters are stored in the nitrogen freezer before filling it with liquid nitrogen.

Goblets are stacked and removed one by one with the lifter. Goblets must be handled in the cold environment of the neck of the nitrogen freezer to ensure even sample temperature.

## TECHNICAL CHARACTERISTICS

Diameter: 70 mm

### Canister with handle for standard goblets ø 65 mm without cover

2-shelf 007147	3-shelf 007148	4-shelf 007149	5-shelf 007150	6-shelf 007151
-------------------	-------------------	-------------------	-------------------	-------------------

1

### Canister with handle and white flag for Daisy goblets

2-shelf 008644	3-shelf 008645	4-shelf 008646	5-shelf 007198	6-shelf 007199
-------------------	-------------------	-------------------	-------------------	-------------------

1

### Plastic handle (colored flag)

White 007328 ○	Yellow 015693 ●	Salmon 015694 ●	Pink 015695 ●	Dark Green 015696 ●
Turquoise 015697 ●	Orange 015698 ●	Violet 015699 ●	Grey 015706 ●	

10

014175	Permanent black markers	2
026924	Medium forceps 23 cm	1
026925	Long forceps 110 cm	1
022112	Rack for 24 daisy goblets	1
021998	Rack for 32 daisy goblets	1





# Identification rods for visotubes



## DESCRIPTION

These ID rods are a little bit longer than straws and are used to identify individual visotubes.

### Medium identification rods for visotubes

100

Yellow 006331 ● White 006762 ○ Red 006763 ● Grey 006774 ● Orange 006775 ● Pink 006876 ●

### Mini identification rods for visotubes

100

White 006330 ○ Yellow 006332 ● Red 006777 ● Pink 006779 ● Orange 006786 ● Grey 006787 ●  
Blue 006782 ● Pistachio 006783 ● Turquoise 023872 ● Mauve 023871 ● Mastic 023870 ○

# Insulated transport box

015937 Bag of 5 insulated boxes



## DESCRIPTION

Sperm transport prepared for intrauterine insemination. HDPE box with a precut polyurethane foam to hold a tube. These dimensions are compatible with all round or cone-shaped 5-15 mL culture tubes.

Two hours before use, the box can be placed in an incubator at 37°C to maintain an optimum temperature when transporting a tube containing sperm prepared in the laboratory for the insemination clinician. The box is suitably insulated to preserve sperm motility.

## TECHNICAL CHARACTERISTICS

Length: 120 mm  
Diameter: 65 mm



## EQUIPMENT

Nano-Digitcool  
Digitcool controlled-rate freezers  
Craft™ pump  
SYMS  
SYMS III  
SYSO  
PACE  
MAPI  
DIVA  
Integral HSV



# Nano-Digitcool

CE marked

025680 Nano-Digitcool



## DESCRIPTION

The compact controlled rate freezer solution for daily use for all cryopreservation applications.

Digitcool freezers are used for controlled-rate freezing of biological samples (plasma, blood cells, tissue, gametes, etc.). Stainless steel Digitcool freezers are easy to maintain and disinfect. They are easy to set up and allow the user to optimally control the various protocols.

- Vertical nitrogen flow with vaporization
- Standalone operation available (emergency mode without IT)
- Traceability: CryoBioSoft software (aligned CFR21)
- Freezing of bags, straws, tubes, etc.
- Display of freezing phases, results and archives

## TECHNICAL CHARACTERISTICS

Weight: 55 Kg

Dimensions: 772 x 475 x 472mm

Chamber dimensions (inside): 238 x 178 x 200mm

Volume: 11.5 L

Capacity:

- 33 CBS High Security straws/
- 192 2 mL tubes
- 15 DF200 bags

Power: 1200 W

Voltage: 220 V / 50Hz / 8 A



- 025433 Tubes rack for Nano-Digitcool
- 024572 Straws rack for Nano-Digitcool
- 025327 DF 200 bags rack for Nano-Digitcool



# Digitcool controlled-rate freezers

- 007209 Digitcool
- 007210 Mini-Digitcool
- 007208 Micro-Digitcool
- 025680 Nano-Digitcool



## DESCRIPTION

Digitcool freezers are used for controlled-rate freezing of biological samples (plasma, blood cells, tissue, gametes, etc.). Stainless steel Digitcool freezers are easy to maintain and disinfect. They are easy to set up and allow the user to optimally control the various protocols.

## ADVANTAGES

- Temperature range: +50°C to -150°C
- Cooling rate: 0.1 to 60°C/min
- Automatic reheating, drying and return to room temperature at the end of the cycle
- Programmer/regulator, hot/cold regulator and plug-in
- Temperature measured by PT 100 ohm (chamber and product)
- Digital temperature display (chamber, program)
- Can be connected to a computer terminal (portable or desktop) with control using the Cryobiosoft software package
- Regulation based on "chamber" temperature
- Liquid nitrogen dispensed through a self pressurized reservoir with a 60 or 120 liter capacity (with minimum pressure of 1 bar)

	Digitcool	Mini-Digitcool	Micro-Digitcool	Nano-Digitcool
<b>External dimension</b>	1170x800x1000mm	770x510x730mm	600x380x520mm	722x475x472mm
<b>Weight</b>	130 kg	58 kg	38 kg	55 kg
<b>Internal dimension</b>	960x470x320mm	640x320x420mm	490x325x230mm	238x178x200mm
<b>Volume</b>	150 L	90 L	26 L	11.5 L
<b>Sample capacity</b>	3 000 CBS straws 2304 CBS tubes 32 DF200 bags / 32 DF700 bags	1 392 CBS straws 576 CBS tubes 32 DF200 bags / 16 DF700 bags	240 CBS straws 192 CBS straws 15 DF200 bags / 9 DF700 bags	33 CBS straws 192 CBS straws 15 DF200 bags
<b>Power</b>	2500 W	2000 W	1000 W	1200 W
<b>Voltage</b>	220V/50Hz/16A	220V/50Hz/10A	220V/50Hz/6A	220V/50Hz/6A

# Craft™ pump

005553 Craft™ pump - Rocket vacuum pump (comes with accessories)



## DESCRIPTION

Aspiration of follicular fluid and oocytes. The Craft™ pump is specially designed for gentle and controlled aspiration, at a preset negative pressure, of oocytes by follicular aspiration.

## TECHNICAL CHARACTERISTICS

Dimensions (L x W x H): 20 x 14 x 12 cm

Weight: 3.2 kg.

Pressure: 0 - 400 mm Hg

- 015621 Craft™ pump foot switch
- 006553 Craft™ pump tubing
- 018204 Craft™ pump tank
- 018268 Craft™ pump tank plug
- 019270 Luer-Lock connector for Craft™ pump tubing

# SYMS

016399 SYMS sealer



## DESCRIPTION

Manual sealer for CBS™ High Security straws. Cryo Bio System has developed a sealer for CBS™ High Security straws in ionomeric resin. The sealer is connected to the mains and operated by a push-button or foot switch as desired.

## TECHNICAL CHARACTERISTICS

Dimensions (L x W x H): 230 x 220 x 170 mm

Weight: 6 kg

Power supply : 220 V / 60 ou 50 Hz

009848 SYMS spare parts kit



# SYMS III

CE marked

## 025547 SYMS III sealer



### DESCRIPTION

Sealer for CBS™ High Security straws, tubes and vitrification straws.

The SYMS III sealer is designed to heat seal CBS™ High Security 0.3 ml, 0.5 ml and CBS™ High Security Vitrification straws, and the CBS™ High Security tube, for optimal cryopreservation of biological samples.

### TECHNICAL CHARACTERISTICS

Dimensions (L x W x H): 335 x 250 x 105 mm

Weight: 3 kg

Power supply: 110 ou 220 V / 60 ou 50 Hz



### FEATURES

- Multilingual interface (French, English, Spain and Chinese) + 4 optional languages
- Color touch screen compatible with the use of laboratory gloves
- Machine cycle display: pre-heating, ready status and sealing in progress
- Two sealing modes: automatic detection or operator-controlled via the touch screen
- Fault signal with messages and alarms
- Display and tracking of maintenance modes
- Easy to clean and service.

EQUIPMENT

## 026550 Set of sealing jaws for SYMS III

# SYSO

024922 SYSO



## DESCRIPTION

Automatic CBS High Security tube opening device.

The SYSO opening device can be used under laminar flow and is designed to open CBS High Security tubes with a hot wire.

- The carousel can hold up to 6 CBS High Security tubes (opening individually or in succession).
- User-friendly touch screen
- 8 languages available
- The wire is systematically sterilized by pyrolysis after each tube is opened.

## TECHNICAL CHARACTERISTICS

Dimensions (L x W x H): 358 x 275 x 157 mm

Weight: 2.5 kg

Power supply: 110 ou 220 V / 60 ou 50 Hz

## FEATURES

The SYSO opening machine is a worktop device for lab benches which can be used under laminar flow. It uses a hot wire to open CBS™ High Security Tubes and has applications which include:

- Epidemiological research departments
- Biobanks
- Serum banks
- Cellular and gene therapy units
- Vaccine-manufacturing pharmaceutical companies (living cells)
- Gene banks (animal, plant, microbiological)
- Reproductive biology laboratories
- Gamete and gonadal tissue banks



# PACE

018451 PACE 220 V / 50 Hz  
018450 PACE 110 V / 60 Hz



## DESCRIPTION

Semi-automatic system for filling biological samples into CBS™ High Security straws.

From a sample primary tube, PACE fills CBS™ High Security straws and automatically seals both ends of CBS™ High Security 0.3 or 0.5 ml straws, which can be pre-identified.

PACE is the ideal CBS™ robot for medium to large-scale projects with preset archiving protocols. PACE is compatible with CBS™ High Security straws - pre-printed or not - with bar code or alphanumeric code.

The system comprises a filling and sealing unit with control unit.

## TECHNICAL CHARACTERISTICS

- PACE  
Dimensions (L x W x H): 380 x 300 x 370 mm  
Weight: 25 kg
  - Control Unit  
Dimensions (L x W x H) : 410 x 365 x 155 mm  
Weight: 14 kg
- Power supply:  
110 or 220 V / 60 or 50 Hz

007454	Sterile CBS™ injection tubing (5 x 10)	50
018620	Box of long sterile CBS™ injection tubing	25
007451	Sterile CBS™ aspiration tubing (5 x 10)	50

# MAPI

## 007218 MAPI



### DESCRIPTION

Automatic biological sample filling and identification system for CBS High Security straws.

From a primary tube, MAPI automatically fills, seals, prints out and validates the identification of CBS 0.3 or 0.5 mL straws (bar code or alphanumeric data).

MAPI features a filling robot, a control unit, a special liquid nitrogen ink-jet type printer and a PC with the MAPI pilot software. The robot is placed on a special lab bench at ergonomical height.



### TECHNICAL CHARACTERISTICS

- MAPI  
Dimensions (L x W x H): 760 x 260 x 470 mm  
Weight: 35 kg
- Worktop  
Dimensions (L x W x H): 1200 x 600 x 900 mm  
Height with machine: 1260 mm  
Weight with machine: 102 kg
- Control unit  
Dimensions (L x W x H): 430 x 380 x 190 mm  
Weight: 14 kg
- Domino printer  
Dimensions (L x W x H): 650 x 450 x 375 mm  
Weight: 20 kg  
Active printer vapor extractor duct, not included (diameter: 80 mm)  
Power supply:  
110 or 220 V / 60 or 50 Hz

007454	Sterile CBS™ injection tubing (5 x 10)	50
018620	Box of long sterile CBS™ injection tubing	25
007451	Sterile CBS™ aspiration tubing (5 x 10)	50

# DIVA

020984 DIVA with Domino printer  
020983 DIVA without printer



## DESCRIPTION

Automatic straw filling and positive identification of biological samples. Using a primary sample tube, DIVA fills and seals CBS High Security 0.5 mL straws (standard plug). It also prints and validates the identifier (bar code GS1 128 or alphanumerical code) on each straw. A color sorting system collects the straws to store the production in Daisy goblets.

## TECHNICAL CHARACTERISTICS

- L x W x H : 1208 x 660 x 1600 mm
- Weight: 100 kg without printer
- Electrical consumption: 400 W
- Power supply: 110 or 220 V
- Frequency: 60 or 50 Hz
- Service temperature: +15°C to +32°C
- Maximum elevation: 2 000 m
- Relative humidity: 80% at +32°C



# Integral HSV

027807 Integral HSV Vitrification unit



## DESCRIPTION

The INTEGRAL HSV vitrification unit is designed for vitrification, packaging and opening of CBS High Security straws in Reproductive Biology Laboratories.

## TECHNICAL CHARACTERISTICS

Width: 283 mm

Length: 487 mm

Height: 265 mm with cover, 222 mm without

Chamber volume: 5L

Weight : 5 kg

027636 Box of 5 opening devices for CBS™ High Security Vitrification straw

027172 Opening set (holder + device) for CBS™ High Security Vitrification straw



## DESCRIPTION

The opening device for CBS™ High Security Vitrification straws has been designed exclusively to open CBS™ High Security Vitrification straws. It is an ambidextrous device. It can be held either directly in the hand or using a "holder" (an accessory designed to keep the user further from the liquid nitrogen)

## Blister of 4 CBS™ High Security Vitrification straws

Red	White	Yellow	Pink	Blue	Green
025246	025247	025248	025249	025250	025251

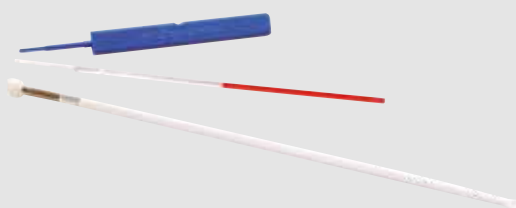

## DESCRIPTION

The High Security Vitrification straw is made of ionomeric resin, a capillary tube with a clear runner, co-injected with its colored handling rod, and a blue insertion device.

**For more information: p. 10-11**





Connected to... **LIFE SCIENCES**

## Authorised distributor

### In Australia:

For customer service, call 1300-735-292  
To fax an order, use 1800-067-639  
To email an order, [ordersau@thermofisher.com](mailto:ordersau@thermofisher.com)

### In New Zealand:

For customer service, call 0800-933-966  
To fax an order, use 0800-329-246  
To email an order, [ordersnz@thermofisher.com](mailto:ordersnz@thermofisher.com)

**ThermoFisher**  
SCIENTIFIC

Cryo Bio System  
ZI n°1 Est  
61300 L'Aigle  
+33 (0)233 346 464  
[contact@cryobiosystem-imv.com](mailto:contact@cryobiosystem-imv.com)

Cryo Bio System Netherlands  
Nifa Technologies  
Pallasweg 22  
8938 AS Leeuwarden  
+31 58 2123279  
[www.nifa.nl](http://www.nifa.nl)  
[info@nifa.nl](mailto:info@nifa.nl)

Cryo Bio System Italy  
Via Stefano Merli  
29122 Piacenza  
+39 0523 36 00 10  
[info@imv-technologies.it](mailto:info@imv-technologies.it)

Cryo Bio System USA  
11725 95th Avenue North  
Maple Grove, MN 55369  
+1 763 488 1881  
[contact@imvusa.com](mailto:contact@imvusa.com)

Cryo Bio System India  
Plot No 750, Phase V, Udyog Vihar  
Gurgaon 122016 (Haryana)  
+91 124 400 44 30/31/32  
[contact@imvindia.com](mailto:contact@imvindia.com)

Cryo Bio System China  
Floor 12, Building A,  
No. 400 Pudian Road,  
Pudong, Shanghai 200122  
+86 21 50586948,  
[contact@imvchina.com](mailto:contact@imvchina.com)

Leja  
Luzernestraat 10  
2153 GN Nieuw-Vennep  
Pays Bas  
+31 (0)252-621 848  
[www.leja.nl](http://www.leja.nl)  
[info@leja.nl](mailto:info@leja.nl)



[www.cryobiosystem-imv.com](http://www.cryobiosystem-imv.com)  
[contact@cryobiosystem-imv.com](mailto:contact@cryobiosystem-imv.com)