



laboratory glassware, plasticware  
& accessories

# Contents

<b>page</b>	<b>contents</b>
2 - 3	Welcome & what's new
4	Our history
5	Celebrating the Pyrex® centenary year
6 - 10	Our famous brands Pyrex®, MBL®, Quickfit®, Azlon®, Rotaflo®, SVL®
11	Custom made glassware
12	Custom printed washbottles
13	Contact us
14 - 286	Products A-Z
287 - 297	Technical section – glassware
298 - 302	Technical section – plasticware
303 - 306	Index by product name
307 - 318	Index by product code
319	Order information & customer support
320	Terms & conditions

# Welcome...

We are very pleased to welcome you to the 2015 Edition of the SciLabware glassware, plasticware and accessories catalogue. Our biggest catalogue yet!

The following pages feature over 3,000 general purpose and specialised glassware and reusable plastic laboratory products carrying some of the best names in science Pyrex®, Quickfit®, MBL® and Azlon®.

Whilst all the long-standing and trusted products are listed in the catalogue, we have remained focused on our key task to provide our customers with new solutions and products to advance practical sciences. Within this catalogue are over 250 new products and packaging solutions - these are indicated by a **New** flash. In addition, we continue to augment the product information; providing improved conformity and batch certification, in-depth FAQs and expanding the compliance of our products for specific science specialities.

At SciLabware, excellence is at the heart of everything we do. We achieve this by enforcing meticulous quality control, adhering to the most rigorous international standards and employing world class glassblowers and skilled polymer technicians. In addition to this, we are proud to provide world class after-sales support. Our product managers, sales team and customer service staff will be happy to discuss your individual needs in more detail.

With our comprehensive product portfolio and our wide range of production capabilities for glass and plastic, we are sure you will find SciLabware the right partner for all your standard laboratory glassware, plasticware and customised special products.

As always we want your feedback. You can write to SciLabware at **info@scilabware.com** with any comments, queries or questions and we promise to respond to every email we receive from you. Your direct feedback is essential to us as we build the SciLabware value for the future.

We hope you find everything you need in this catalogue, however, if you need more information or need to get in touch, please do so using one of the many methods detailed on pages 13 and 319 or simply visit **www.scilabware.com**.

We look forward to working with you in 2015 and beyond.

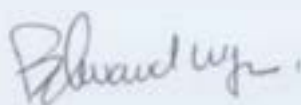

Edward Wynn  
Chief Executive Officer

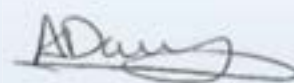

Andy Davies  
Sales & Marketing Director

# What's new...

The 2015 SciLabware catalogue is our biggest catalogue yet, featuring over 250 new products from our well known brands: **Pyrex®**, **Azlon®**, **Quickfit®**, **MBL®**

## PYREX®

GLS80  
wide mouth  
media bottles

Pages 44-45



GL45  
bottles and  
connection  
system caps

Pages 51-53



Cell culture  
glassware

Pages 142-143



Tall form  
heavy  
duty  
beakers

Page 38



## Azlon

Low form  
Griffin  
beaker

Page 42



Washbottles

Pages 73-81



Bulk packed  
bottles

Pages 60, 61,  
63, 65, 68



Polycarbonate  
media bottles

Pages 58-59



## MBL®

Polyethylene  
stoppers

Page 258



Microscale  
chemistry  
kit

Page 230



Soda lime  
bottles

Pages 55-56



Soda lime  
pasteur  
pipettes

Page 217



FM 587456  
SciLabware is an ISO 9001  
registered company.

In addition to the highlights here, the catalogue features many more new products – look out for the **New** symbol on the product pages.

We have continued to develop supplementary information for our products. New compliance and batch certification is available for many products, including Pyrex beakers and flasks and Azlon bottles and volumetric flasks, to meet all the regulatory needs of the modern laboratory. Keep a look out for details in the product listings and in the technical section on pages 287-302.

# Our timeline...

## Our story began with two innovations in laboratory glassware.

In 1921 a new heat resistant glass called Pyrex® was made under licence in the UK for the first time.

In 1934 a glassblower at the Triplex Safety Glass Company in the UK made samples of laboratory glassware fitted with ground-glass joints, a development which attracted the interest of the Royal Society. Large scale manufacturing of the new product was soon underway.

Following several acquisitions and a number of changes in ownership, during 2005 the company became Barloworld Scientific, home of some of the world's most famous brand names in laboratory equipment and consumables.

The glassware and reusable plastic labware side of the business began trading as SciLabware Limited in April 2008.

In 2011 the business became part of the DURAN Group, a world leader in the manufacture of borosilicate glass. In 2013, SciLabware relocated to new Head offices and manufacturing facility based in Stoke-on-Trent, UK.

Today SciLabware is a leading supplier of high quality reusable laboratoryware under the widely recognised brands of Pyrex®, Quickfit® and MBL® for glassware and Azlon® for plasticware selling through an extensive network of global distribution partners.

\*Pyrex® is a trademark used under licence from Corning Inc.

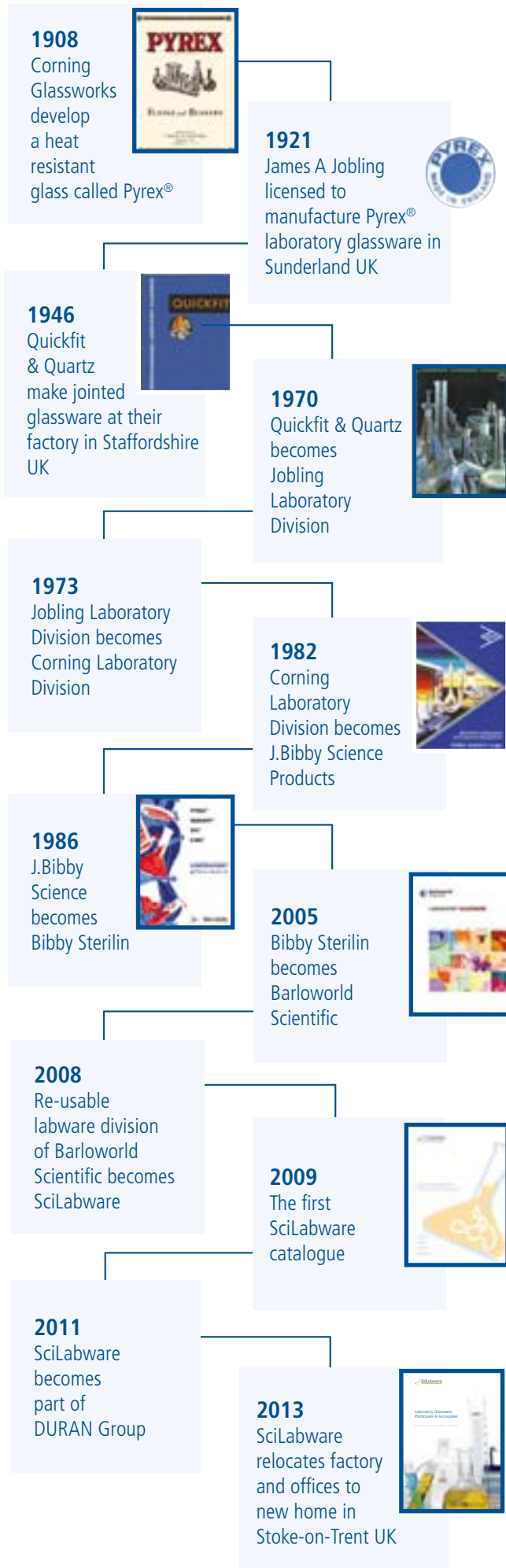

# A celebration...

**2015 marks the 100th anniversary of Pyrex® glass, considered today as the quality standard for laboratory glassware around the world.**

SciLabware is the European manufacturer of Pyrex® laboratory glassware, and is delighted to be celebrating the 100th anniversary of this illustrious brand.

Few products are made so well that their brand becomes a generic name for everything similar... Pyrex® is one of those few.

Since its introduction in 1915, Pyrex® glass has advanced the research and development of science, medicine and space exploration; playing a pivotal role in many historic achievements through its reliability, strength, performance, safety and chemical resistance.

In the 1950s, the Pyrex® Fernbach flasks were used to grow the original cultures for the polio vaccine, and the first radio message from the South Pole was transmitted over radio antennas using Pyrex® insulators.

Throughout the past century Pyrex® has become the trusted glass brand across many industries and applications. With the world renowned quality inherent in its products, we look forward with confidence to the next one hundred Pyrex® years.

Few products are made so well that their brand becomes a generic name for everything similar ...

... Pyrex® is one of those few



**PYREX®**  
**100**  
1915 - 2015

## 100 years of PYREX®

2015 marks the one hundredth anniversary of the Pyrex® glass brand, considered today as the quality standard for laboratory glassware around the world.

SciLabware is delighted to be celebrating the centenary year of this illustrious brand.

**PYREX®**  
**100**  
1915 - 2015



# PYREX®

After first receiving its registered trademark in 1915 the Pyrex® name has become a world famous brand in science, thanks to its well documented thermal and chemical resistance properties that continue to be trusted throughout the scientific community around the globe.

Pyrex® borosilicate glass was the result of an early twentieth century research project to develop a material for use in the railroad industry, with the development of the successful low-expansion glass we know today as Pyrex®. Corning Glass Works registered the name Pyrex in 1915 and later registered a patent for Pyrex® glass in 1919.

SciLabware continues to produce Pyrex® laboratory glassware under licence from Corning Inc. using traditional glassblowing techniques and the latest in glass production technology.

Today more than 800 items of glassware carry the famous Pyrex® name including beakers, bottles, flasks, dishes and test tubes, all manufactured to exacting quality standards.

For more information, please contact SciLabware or visit the Pyrex100 webpage for more history and the origins of the Pyrex® brand.

# MBL®

MBL® has an international reputation for quality and performance.

The range comprises over 300 products, a wide selection of borosilicate and soda-lime glass products that includes volumetric glassware, funnels, thermometers and reagent bottles.

MBL® volumetric glassware products are ideal for general volumetric applications and offer exceptional value for money with one of the widest selections available offering unbeatable choice, accuracy and performance.







Quickfit® pioneered the concept of interchangeable joints in 1934.

Today, the Quickfit® name is renowned throughout the world for quality and reliability.

Quickfit® ground-glass joints are precision manufactured with an accurate taper and smooth finish for leak-free performance and assured interchangeability.

The Quickfit® range comprises over one thousand individual products that feature interchangeable ground glass joints, which can be combined together enabling the user to construct the widest range of assemblies.

Quickfit® glassware is manufactured exclusively from Pyrex® borosilicate glass. This type of glass has excellent chemical resistance characteristics and a very low co-efficient of expansion, allowing use at both elevated and sub-zero temperatures.

For over 80 years, Quickfit® has been the first choice of scientists who demand maximum performance and value for money.



# Azlon®

For more than half a century, the Azlon® name has been synonymous with high quality affordable plastic laboratory ware.

Available in a variety of polymers, Azlon® reusable plastics cover a broad range of applications in the modern laboratory, offering more than 700 products, including bottles, wash bottles, measuring cylinders, jugs and beakers.

Azlon® products are manufactured to the highest quality standards utilising a range of plastic moulding techniques including blow and injection moulding.

Leadership in polymer science and many important innovations have combined to make Azlon® one of the most widely known and respected brands in durable plastic labware.



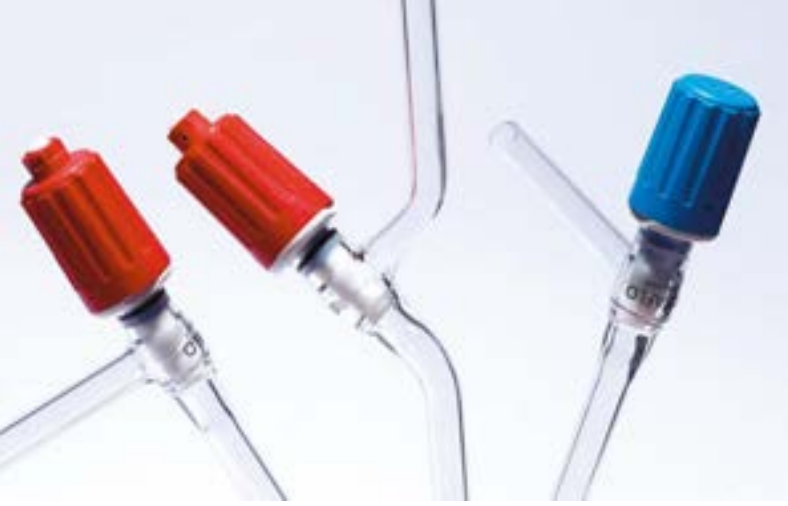

# ROTAFLO®

Rotaflo® stopcocks are renowned for their performance and reliability. The range comprises a wide selection of general purpose stopcocks offering fine flow control and high vacuum versions which are individually tested for guaranteed performance.



# SVL®

SVL® glassware has screwthread joints that are easily connected together using purpose made couplings. Only glass and PTFE come into contact with the chemicals being used to provide a grease-free and corrosion-resistant pathway.

SVL® glass is manufactured from Pyrex® borosilicate glass for maximum resistance to chemical attack and thermal shock.



# Custom made glassware

We have been recognised as one of the world's leading manufacturers of technical glassware for more than 70 years. We make over 2,500 standard products from beakers and bottles to flasks, dishes and test tubes.

However, if you have a specialist glass application that is not covered by the items in this catalogue we are pleased to offer you our unique personal glassblowing services.

Whatever your industry or application, from the production of small to high volume quantities, you will find us helpful, competitive in price and unbeatable in quality.

We work to the most rigorous British and International standards and can offer the full spectrum of specialist glassware services including:

- Glassblowing
- Lathe Work
- Grinding and ground glass joints
- Moulding
- Cutting and shaping
- Glass sinters and filter ware
- Calibration and graduation
- Screen-printing with your logo or message

Our skills and expertise are not only confined to the world of science. We have helped to develop glassware for projects from laser tubes for a laser optics company, apothecary bottles for a pharmaceutical chemist and from viscometers for an oil company, to glassware for an innovative piece of cookery equipment.

No matter how challenging your requirement, if the component material is glass and the priority is quality, we can provide the solution.

To find out how you can turn your concept into a special glass product, follow the links on our website [www.scilabware.com](http://www.scilabware.com) and enter your details. Our technical specialists will contact you to help with your enquiry

Alternatively you can contact us by phone, fax or email:  
tel: +44(0)1782 444406  
fax: +44(0)1782 940436  
email: [customglass@scilabware.com](mailto:customglass@scilabware.com)

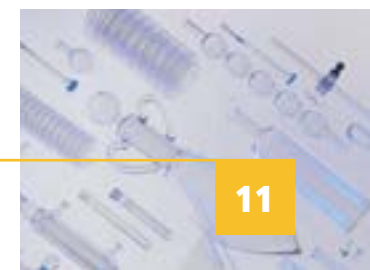

# Custom printed wash bottles

**Design your own wash bottle and we will print it for you.**

Available in a range of bottle sizes from 250ml - 1000ml

- Wide or narrow mouth
- Venting or non-venting
- Choice of cap colours
- Minimum order 500 pieces

To find out more about our custom bottle printing service follow the 'contact us' link on our website [www.scilabware.com](http://www.scilabware.com) and enter your details. Our technical specialists will contact you to help with your enquiry.

Alternatively give us a call, or send an email to: [azlon@scilabware.com](mailto:azlon@scilabware.com)

For more information about our full range of standard Driplok® venting and non-venting wash bottles see pages 72 to 81 in this catalogue.



# Contact us

The SciLabware range of glassware, reusable plasticware and accessories is available to customers through an extensive network of distributors.

To find your local dealer, simply visit our website and click on the 'Where to Buy' tab. If you need any additional help please get in touch using one of the many ways to contact SciLabware listed below.

 [www.scilabware.com](http://www.scilabware.com)

Our website is a one-stop information hub for over 3,000 standard products.

As well as full technical specifications for every item in our range it offers advice on selection of products and their usage from our qualified scientists and manufacturing experts. The website also has promotions, useful tips, FAQs, downloads, images and product certification.

## By Post



Head Office:  
SciLabware Limited  
Unit 4, Riverside 2, Campbell Road  
Stoke on Trent ST4 4RJ  
UK

## Email



**General enquiries**  
[info@scilabware.com](mailto:info@scilabware.com)

**Glass technical enquiries**  
[glass@scilabware.com](mailto:glass@scilabware.com)

**Plastics technical enquiries**  
[azlon@scilabware.com](mailto:azlon@scilabware.com)

## Phone



+44 (0) 1782 444406  
+44 (0) 1782 940436 (fax)

 [@scilabware](https://twitter.com/scilabware)

Keep up to date with all the latest company news on our twitter feed.



## Adapters, cone/screwthread



- With screwthread joint complete with plastic cap, silicone rubber ring and PTFE washer
- Ideal for securing thermometers, gas inlet tubes, etc.

Product Code	Thread size (mm)	Cone size	Acceptable dia. through screwcap (mm)	Pack qty.
ST51/13	13	14/23	6.0 - 7.0	2
ST51/18	18	14/23	7.0 - 8.5	2
ST52/13	13	19/26	6.0 - 7.0	2
ST52/18	18	19/26	7.0 - 8.5	2
ST52/24	24	19/26	10.5 - 11.5	2
ST53/13	13	24/29	6.0 - 7.0	2
ST53/18	18	24/29	7.0 - 8.5	2
ST53/24	24	24/29	10.5 - 11.5	2
ST54/13	13	29/32	6.0 - 7.0	2
ST54/18	18	29/32	7.0 - 8.5	2
ST54/24	24	29/32	10.5 - 11.5	2
ST54/28	28	29/32	18.0 - 19.0	1
ST55/28	28	34/35	18.0 - 19.0	1

 Spare plastic caps, rubber rings and PTFE washers are listed on page 206.

## Adapters, expansion



- Useful for the connection of dissimilar sized ground glass joints
- Large sized socket at the top and small sized cone at the base

Product Code	Socket size	Cone size	Pack qty.
XA10	14/23	10/19	2
XA21*	19/26	14/23	2
XA31	24/29	14/23	2
XA32	24/29	19/26	2
XA41*	29/32	14/23	2
XA42*	29/32	19/26	2
XA43	29/32	24/29	2
XA52	34/35	19/26	2
XA53	34/35	24/29	2
XA54	34/35	29/32	2
XA64	40/38	29/32	1
XA74	45/40	29/32	1



 \* Complies with DIN 12257

## Adapters, reduction



- Useful for the connection of dissimilar sized ground glass joints
- Small sized socket at the top, large sized cone at the bottom

Product Code	Socket size	Cone size	Pack qty.
DA01	10/19	14/23	2
DA12*	14/23	19/26	2
DA13	14/23	24/29	2
DA14*	14/23	29/32	2
DA23	19/26	24/29	2
DA24*	19/26	29/32	2
DA25	19/26	34/35	2
DA34	24/29	29/32	2
DA35	24/29	34/35	2
DA36	24/29	40/38	1
DA37	24/29	45/40	1
DA38	24/29	50/42	1
DA39	24/29	55/44	1
DA45	29/32	34/35	2
DA47*	29/32	45/40	1
DA56	34/35	40/38	1
DA57	34/35	45/40	1
DA58	34/35	50/42	1



 \* Complies with DIN 12257

## Adapters, reduction, PTFE



- Useful for the connection of dissimilar sized ground glass joints, works with Quickfit®
- Excellent chemical resistance
- Suitable for food contact applications in accordance with USA regulations
- Operating temperature up to 260°C
- Manufactured from USP Class VI grade PTFE

Product Code	Socket size	Cone size	Pack qty.
SWN902	10/19	14/23	1
SWN908	19/26	34/35	1
SWN909	24/29	29/32	1
SWN911	29/32	34/35	1





# Adapters



## Adapters, multiple, with two parallel necks



- With two parallel necks

Product Code	Socket size	Side socket size	Cone size	Pack qty.
MA1/11*	14/23	14/23	14/23	1
MA1/2*	19/26	19/26	19/26	1
MA1/3	19/26	19/26	24/29	1
MA1/33	24/29	24/29	24/29	1
MA1/44*	29/32	29/32	29/32	1

 \* Complies with DIN 12594



## Adapters, multiple, with two necks



- With two necks :
  - One vertical
  - One angled at 45°

Product Code	Socket size	Cone size	Pack qty.
MA2/2	19/26	19/26	1
MA2/3	19/26	24/29	1



## Adapters, multiple, with three necks



- With three necks:
  - Two vertical
  - One at 45°

Product Code	Socket size vertical necks	Socket size angled neck	Cone size	Pack qty.
MA4/23	19/26	19/26	24/29	1

## Adapters, swan neck



- With screwthread joint to accept thermometers and tubes etc.

Product Code	Socket size	Cone size	Thread size (mm)	Pack qty.
MA6/22	19/26	19/26	13	1
MA6/33	24/29	24/29	13	1

 Acceptable diameter of thermometer through the screwcap is 6 - 7mm. Spare plastic caps, rubber rings and PTFE washers are listed on page 206.



## Adapters, receiver



- Delivery receiver with short or long stem
- Useful for feeding distillate from condensers into receiving vessels

Product Code	Socket size	Approx stem length (mm)	Bend Angle	Pack qty.
RA1/01	14/23	65	105°	1
RA1/02	19/26	65	100°	1
RA1/03	24/29	65	100°	1
RA1/04	29/32	65	100°	1
RA1/10	10/19	120	120°	1
RA1/11	14/23	190	105°	1
RA1/12	19/26	200	100°	1
RA1/13	24/29	200	100°	1
RA1/14	29/32	200	100°	1

 For plastic retaining clips to secure glassware, please see page 200.



## Adapters, receiver, straight type



- Delivery receiver with straight stem

Product Code	Socket size	Overall height (mm)	Pack qty.
RA1/22	19/26	180	1
RA1/23	24/29	180	1



# Adapters



## Adapters, receiver, side socket



- With side socket inclined at an angle of 105°

Product Code	Socket size	Cone size	Approx overall height (mm)	Pack qty.
RA4/11	14/23	14/23	120	1
RA4/22	19/26	19/26	120	1
RA4/23	19/26	24/29	120	1



## Adapters, receiver, plain bend



- Plain bend without vent

Product Code	Socket size	Cone size	Approx overall height (mm)	Bend Angle	Pack qty.
RA9/11	14/23	14/23	90	100°	1
RA9/22	19/26	19/26	100	100°	1
RA9/23	19/26	24/29	110	100°	1
RA9/33	24/29	24/29	125	100°	1
RA9/44	29/32	29/32	140	100°	1



## Adapters, receiver, bend with vent



- Bend with vent
- With side-arm to provide vent to atmosphere
- Avoids the problems of 'closed systems'

Product Code	Socket size	Cone size	Approx overall height (mm)	Bend Angle	Pack qty.
RA2/11	14/23	14/23	80	105°	1
RA2/22	19/26	19/26	106	100°	1
RA2/23	19/26	24/29	120	100°	1
RA2/33	24/29	24/29	130	100°	1



The side-arm is for venting purposes and not for connection to a vacuum source. For adapters with vacuum connection, see RA3: and RA13: series.

## Adapters, receiver, vacuum, angled



- Delivery stem within cone
- With side-arm for connection to a vacuum supply
- Easy connection to flexible tubing via detachable plastic screwthread connector

Product Code	Socket size	Cone size	Approx overall height (mm)	Bend Angle	Pack qty.
RA3/11/SC*	14/23	14/23	110	105°	1
RA3/22/SC	19/26	19/26	140	100°	1
RA3/23/SC	19/26	24/29	140	100°	1
RA3/33/SC*	24/29	24/29	150	100°	1
RA3/44/SC*	29/32	29/32	165	100°	1



 *Complies with DIN 12594  
For spare screwthread connectors, please refer to page 104.*

## Adapters, receiver, vacuum, straight



- Delivery stem within cone
- With side-arm for connection to a vacuum supply
- Easy connection to flexible tubing via detachable plastic screwthread connector

Product Code	Socket size	Cone size	Approx overall height (mm)	Pack qty.
RA13/33/SC	24/29	24/29	140	1



 *Complies with DIN 12594*

## Adapters, receiver, pig



- Allows up to three flasks\* to be connected to a condenser outlet
- Useful for collecting distillate fractions
- By slightly rotating the adapter a new flask is presented to the distillate
- With side-arm for connection to a vacuum supply

Product Code	Socket size	Cone size	Approx overall height (mm)	Pack qty.
RA5/11/SC	14/23	14/23	110	1
RA5/21/SC	19/26	14/23	110	1



 *It is not dimensionally possible to fit large capacity flasks to these receivers.  
\*Maximum flask capacity is: RA5/11/SC - 50ml flask RA5/21/SC - 100ml flask.*

# Adapters



## Adapters, receiver, vacuum, four flask connector



- Allows four flasks to be connected to a condenser outlet
- Useful for collecting fractions when distilling under vacuum
- Each flask can be progressively filled by rotating the adapter
- Avoids problems of disturbing vacuum conditions when changing flasks
- Choice of collection flasks

Product Code	Description	Socket size	Cone size	Pack qty.
RA11/SC	Screwthread vacuum receiver adapter to take four flasks	19/26	14/23	1
RA12/2	Sloping delivery adapter	19/26	19/26	1
FR25/1S	25ml flask	14/23	-	5
FR50/1S	50ml flask	14/23	-	5
FR100/1S	100ml flask	14/23	-	5

**i** A choice of retaining clips to hold the flasks are detailed on page 200.



## Adapters, receiver, Perkin



- For vacuum distillation work
- Allows receiver flasks to be changed without disturbing the vacuum within the system
- Fitted with 3 x GP Rotaflo® stopcocks with 3.0mm bore PTFE keys:
  - No lubrication required
  - No contaminating greases
  - No chemical corrosion
- With screwcap system for gentle release of vacuum at conclusion of work

Product Code	Capacity (ml)	Socket size	Cone size	Pack qty.
RA6/11/SC	10	14/23	14/23	1
RA6/22/SC	30	19/26	19/26	1
RA6/23/SC	30	19/26	24/29	1
RA6/33/SC	30	24/29	24/29	1

**i** Spare Rotaflo® keys are listed on page 250.

## Adapters, splash head, vertical



- Usually inserted between a flask and condenser to prevent 'carry-over' of raw liquid

Product Code	Socket size	Cone size	Pack qty.
SH17/23	19/26	24/29	1



## Adapters, splash head, sloping



- Popular adapter used in distillation assemblies to prevent raw liquid 'carrying over' from flask to condenser

Product Code	Cone size to fit flask	Cone size to fit condenser	Pack qty.
SH7/02	19/26	19/26	1
SH7/03	24/29	19/26	1
SH7/43	24/29	24/29	1
SH7/0/44	29/32	29/32	1



## Adapters, splash head, vertical distillation



- A splash head for use in distillation assemblies in which the condenser is assembled in the vertical mode
  - Lower cone accepts flask, upper cone accepts condenser
  - Splash head reduces entrainment of raw liquid into the vapour stream

Product Code	Cone size to fit flask	Cone size to fit condenser	Pack qty.
SH7/12	19/26	19/26	1
SH7/13	24/29	19/26	1
SH7/53	24/29	24/29	1



# Adapters



## Adapters, splash head, rotary evaporator, anti-climb



- For use with rotary evaporators
- Protects against liquid ingress into the condenser
- Useful for liquids that have tendency to foam
- Splash heads feature a 29/32 socket

Product Code	Approx capacity (ml)	Socket size	Cone size	Pack qty.
SH15/19	150	29/32	19/26	1
SH15/24	150	29/32	24/29	1
SH15/29	150	29/32	29/32	1



## Adapters, splash head, rotary evaporator, with sinter



- For use with rotary evaporators
- Prevents possible contamination of the condenser from 'bumping' solvents
- Features a coarse porosity 1 sinter to reduce carry over
- Splash heads feature a 29/32 socket

Product Code	Approx capacity (ml)	Socket size	Cone size	Pack qty.
SH16/19	90	29/32	19/26	1
SH16/24	90	29/32	24/29	1
SH16/29	90	29/32	29/32	1



## Adapters, steam distillation head



- A splash-head with integral stem for the introduction of steam into flasks
- Stem is connected to steam supply via detachable screwthread safety connector

Product Code	Cone size to fit flask	Cone size to fit condenser	Pack qty.
SH7/23/SC	24/29	19/26	1



*Screwthread connector, cat no: 4510/02, accepts 9mm bore flexible tubing. Spare screwthread connectors are available on page 104.*

## Adapters, still head



- Used in distillation assemblies for connecting flasks to condenser
- Upper socket designed to accept thermometer either via cone/screwthread adapter or thermometer pocket

Product Code	Cone size to fit flask	Cone size to fit condenser	Socket size	Pack qty.
SH4/1*	14/23	14/23	14/23	1
SH4/22*	19/26	19/26	14/23	1
SH4/2	19/26	19/26	19/26	1
SH4/23	24/29	19/26	14/23	1
SH4/33	24/29	24/29	14/23	1
SH4/24	29/32	19/26	14/23	1
SH4/44*	29/32	29/32	14/23	1
SH4/55	34/35	34/35	14/23	1



\* Complies with DIN 12594  
For cone/screwthread adapters or thermometer pockets, see page 14.

## Adapters, still head, Claisen



- Similar to the SH4: still heads but with extra socket to accept dropping funnel or stirrer etc.

Product Code	Cone size to fit flask	Cone size to fit condenser	Socket size	Pack qty.
SH6/1*	14/23	14/23	14/23	1
SH6/22*	19/26	19/26	14/23	1
SH6/23	24/29	19/26	14/23	1
SH6/33	24/29	24/29	14/23	1
SH6/44*	29/32	29/32	14/23	1



\* Complies with DIN 12594  
PTFE joint sleeves eliminate the possibility of joint seizure, see page 199.

## Adapters, still head, recovery



- Provides a simple vapour conduit between flasks and distillation condensers

Product Code	Cone size to fit flask	Cone size to fit condenser	Bend Angle	Pack qty.
SH1/11	14/23	14/23	75°	1
SH1/22	19/26	19/26	80°	1
SH1/23	24/29	19/26	80°	1
SH1/33	24/29	24/29	80°	1
SH1/44	29/32	29/32	80°	1





# Adapters



## Adapters, still head, recovery, vertical mode



- Used in distillation assemblies in which the condenser is assembled in the vertical mode

Product Code	Cone size to fit flask	Cone size to fit condenser	Pack qty.
SH2/22	19/26	19/26	1
SH2/33	24/29	24/29	1



## Adapters, Solvent still head



- Apparatus for distillation and collection of oxygen free solvents
- Solvent removed from the flask via
  - Top stopcock by syringe
  - Drainage through T-bore stockcock
- Drainage arm utilises a 14/23 cone

Product Code	Approx capacity ml	Approx height (mm)	Cone size	Socket size	Pack qty.
SH9/250	250	225	19/26	19/26	1
SH9/500	500	235	24/29	24/29	1
SH9/1L	1000	270	29/32	29/32	1



Syringes should be purchased separately



The use of solvent still heads involve the use of drying agents and generates hot solvents. Care should be taken when handling these potential hazards.



## Adapters, stopcock, cone



- With GP Rotaflor® PTFE stopcock:
  - No lubrication required
  - No contaminating greases
  - Fine flow control
  - Positive closure
- Detachable plastic screwthread connectors allow rubber hose etc. to be fitted easily and safely

Product Code	Cone size	Stopcock bore (mm)	Pack qty.
MF11/1/SC	14/23	3.0	1
MF11/2/SC	19/26	3.0	1
MF11/3/SC	24/29	3.0	1
MF11/4/SC	29/32	3.0	1



The detachable screwthread connectors accept flexible tubing having a bore of 9mm diameter - see page 104 for details.

## Adapters, stopcock, T shape, cone



- With GP Rotaflo® PTFE stopcock providing fine flow control and positive closure
- Detachable plastic screwthread connectors allow rubber hose etc. to be fitted easily and safely

Product Code	Cone size	Stopcock bore (mm)	Pack qty.
MF11/1B/SC	14/23	3.0	1
MF11/2B/SC	19/26	3.0	1
MF11/3B/SC	24/29	3.0	1



The detachable screwthread connectors accept flexible tubing having a bore of 9mm diameter.



## Adapters, stopcock, socket



- With GP Rotaflo® PTFE stopcock providing fine flow control and positive closure
- Detachable plastic screwthread connectors allow rubber hose etc. to be fitted easily and safely

Product Code	Socket size	Stopcock bore (mm)	Pack qty.
MF14/1/SC	14/23	3.0	1
MF14/2/SC	19/26	3.0	1
MF14/3/SC	24/29	3.0	1



The detachable screwthread connectors accept flexible tubing having a bore of 9mm diameter.



## Adapters, tubing, right angle



- With right angle connection for attachment of rubber hose etc.
- Detachable plastic screwthread connectors allow flexible tubing to be fitted easily and safely

Product Code	Cone size	Pack qty.
MF10/1B/SC	14/23	1
MF10/2B/SC	19/26	1
MF10/3B/SC	24/29	1
MF10/4B/SC	29/32	1
MF10/5B/SC	34/35	1



For spare screwthread connectors, please see page 104.



# Adapters, ampoule breakers



## Adapters, tubing, straight



- With straight connection for the attachment of rubber hose etc.
- Detachable plastic screwthread connectors allow flexible tubing to be fitted easily and safely

Product Code	Socket size	Pack qty.
MF13/2/SC	19/26	1
MF13/3/SC	24/29	1
MF13/4/SC	29/32	1

 Screwthread connector accepts rubber hose with a bore of 9mm.



## Adapters, tubing, side-arm



- With side-arm for the attachment of rubber hose etc.
- Detachable plastic screwthread connector allows flexible tubing to be fitted easily and safely

Product Code	Socket size	Cone size	Pack qty.
MF17/1/SC	14/23	14/23	1
MF17/2/SC	14/23	19/26	1
MF17/3/SC	14/23	24/29	1
MF18/2/SC	19/26	19/26	1
MF18/3/SC	19/26	24/29	1
MF18/4/SC	19/26	29/32	1
MF18/5/SC	19/26	34/35	1
MF18/33/SC	24/29	24/29	1
MF18/44/SC	29/32	29/32	1

 For spare screwthread connectors, please see page 104.



## Ampoule breakers, HDPE



- Enables safe and easy breaking of glass ampoules
- Broken ampoule top is retained for safe disposal
- Choice of size to suit all common glass ampoules

Product Code	Ampoule size	Pack qty.
AWY700	1 - 4ml	1000
AWY702	5 - 10ml	1000

## Arsenic determination apparatus



- Designed for the estimation of arsenic and antimony
- Method uses the formation of a complex between arsine and silver diethyldithiocarbamate with subsequent measurement at 538nm or 5380Å

Product Code	Description	Socket size	Cone size	Pack qty.
1AD/1	Complete Assembly	-	-	1
AD3	Absorption tube	-	24/29	1
FE100/3	100ml Erlenmeyer flask	24/29	-	5

 Reference: Elliot and Loper, Analytical Chemistry, (1974), 46, 2256.



## Aspirator bottles, tubing side-arm

PYREX®

- Tubular side arm for attachment of 9mm bore flexible tubing
- Unground neck to accept rubber stoppers

Product Code	Capacity (ml)	Body diam. (mm)	Neck I.D. at top (mm)	Bottle height (mm)	Pack qty.
1531/06D	250	73	18	131	10
1531/08D	500	89	23	163	10
1531/10D	1000	111	28	200	5
1531/12D	2000	138	28	248	5



## Aspirator bottles, ground glass side-socket

PYREX®

- Complies with ISO 4796
- Ground side socket (size 29/32) to accept stopcock assemblies
- Unground top neck to accept rubber stoppers

Product Code	Capacity (ml)	Body diam. (mm)	Neck I.D. at top (mm)	Bottle height (mm)	Pack qty.
1541/12D	2000	138	28	248	5
1541/16D	5000	181	44	318	1
1541/18D	10000	227	59	398	1
1541/20D	15000	258	59	460	1
1541/22D	20000	288	59	492	1

 Compatible with stopcocks on page 28.



# Aspirators and carboys



## Aspirator bottles, ground glass side-socket and neck **PYREX®**

- Complies with ISO 4796
- Ground side socket (size 29/32) to accept stopcock assemblies
- Ground neck
- Supplied with glass stopper

Product Code	Capacity (ml)	Body diam. (mm)	Neck I.D. at top (mm)	Height with stopper (mm)	Stopper size	Pack qty.
1569/12DP	2000	138	29	262	29/32	2
1569/16D	5000	181	45	333	45/40	1
1569/18D	10000	227	60	414	60/46	1
1569/22D	20000	288	60	508	60/46	1

**i** Compatible with stopcocks as detailed below.



## Aspirator stopcocks with ground cone

**PYREX®**

- For use with Aspirator bottles 1541: and 1569:
- Type 1568/04M with Rotaflo® PTFE key which is chemically inert and requires no lubrication
- Type 1571/02M with traditional glass key

Product Code	Stopcock bore (mm)	Cone size	Overall length (mm)	Pack qty.
1568/04M	3.0	29/32	53	1
1571/02M	4.0	29/32	95	1



## Aspirator bottles, large capacity

- Ideal for storage of distilled water etc.
- Choice of sizes up to 20 litre capacity
- Wide neck with simple glass cover
- Supplied with plastic connector and rubber/PTFE sealing ring
- Accepts either stopcock GP6/10W or glass tubing of 14mm O.D.

Product Code	Capacity (ml)	Ext. neck diam. (mm)	Total height (mm)	Max. diam. (mm)	Pack qty.
1565/16M	5000	100	320	200	1
1565/18M	10000	127	395	234	1
1565/22M	20000	160	500	300	1

 Aspirator and stopcock should be ordered separately.

**PYREX®**



## Aspirator accessories and spares

- Stopcock for use with Aspirator Bottles 1565: series with Rotaflo® PTFE key
- Essential spare connectors and sealing rings for 1565: series

Product Code	Description	Pack qty.
GP6/10W	10mm bore Aspirator Rotaflo stopcock	1
1548/02M	Spare plastic connector for outlet	1
1547/02M	Spare rubber/PTFE sealing ring	1

**PYREX®**

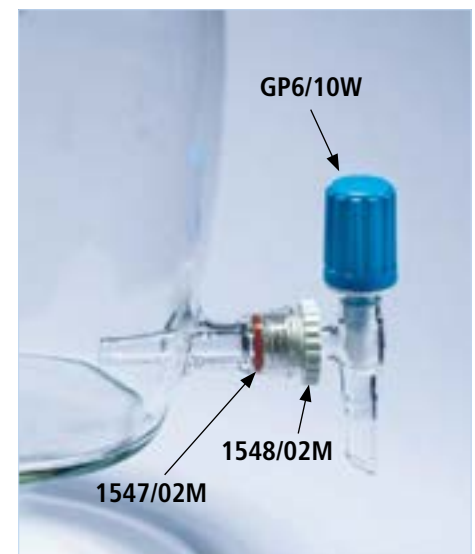

# Aspirators and carboys



## Aspirator, heavy duty, polypropylene





- Squat form for stable location on shelves, bench top or in transit
- Moulded handle for safe and secure carrying
- Clear moulded graduations allowing quick and easy volume assessment
- Leakproof heavy duty stopcock opens and closes in a quarter turn
- Autoclavable polypropylene for easy cleaning and sterilisation
- Caps have moulded drill guides for easy location of probes and feed-lines

Product Code	Capacity (litres)	Thread size (mm)	Height x width (mm)	Pack qty.
BNP05A	5	45	270 x 220	1
BNP10A	10	80	360 x 280	1
BNP20A	20	80	420 x 350	1

## Aspirator, heavy duty, polypropylene, spares

Product Code	Description	Pack qty.
CAP045/H	Spare cap for BNP05A/B - White	10
CGZ85PP	Spare cap for BNP10A/B & 20A/B	1
SCBNP01	Spare stopcock	1

 When autoclaving aspirators always ensure the caps are completely loosened or removed to prevent accidental implosion.

 Carboys can be found on page 32.



## Aspirator, narrow neck, HDPE



- Large capacity aspirators with screw caps
- Ideal for bench-top dispensing of common laboratory liquids/distilled water etc. featuring smooth operating leak-proof stopcocks
- Good resistance to chemical attack
- 5 & 10 Litre aspirators have moulded graduations in Litres and Gallons
- 5 & 10 Litre are octagonal. 25 & 50 Litre are round
- 25 & 50 litre are suitable for food contact applications in accordance with EU and USA regulations

Product Code	Capacity (litres)	Neck I.D. (mm)	Diam. x height (mm)	Shape	Pack qty.
BGH034	5	49	175 x 330	Octagonal	1
BGH036	10	49	220 x 380	Octagonal	1
BGH038	25	80	280 x 580	Round	1
BGH040	50	80	350 x 700	Round	1

 Large carboys can be found on page 32.

## Aspirator, narrow neck, HDPE, spares

Product Code	Description	Pack qty.
SWQ016	Spare stopcock for BGH034 & BGH036	1
SWQ003	Spare stopcock for BGH038, BGH040, BGH068, BGH070 & BWX072	1

## Aspirator, wide neck, HDPE



- Large capacity aspirator with easy fill wide aperture
- Screw cap with water tight rubber seal, leak-proof stopcock and carry handles
- Ideal for bench top dispensing of common laboratory liquids
- Suitable for food contact applications in accordance with EU and USA regulations
- Good resistance to chemical attack

Product Code	Capacity (litres)	Neck I.D. (mm)	Height (mm)	Pack qty.
BGH068	30	240	420	1
BGH070	50	240	640	1
BWX072	100	240	770	1

 Spare stopcocks for this item - SWQ003 can be found on page 30.



## Aspirator, square, HDPE



- Square shape saves space on benchtops and shelves
- Push-in water tight stopcock
- 5L version features 2 moulded handles for safe transportation
- Larger sizes have a carry handle

Product Code	Capacity (litres)	Neck I.D. (mm)	Height x width (mm)	Pack qty.
BSH05A	5	40	325 x 165	1
BSH10A	10	40	365 x 210	1
BSH20A	20	50	465 x 262	1
BSH30A	30	65	525 x 305	1

 Replacement stopcock: 4461/0010





# Aspirators and carboys



## Bottles, carboy, heavy duty, polypropylene

- Good general chemical resistance
- Squat form for easy location on shelves, bench top or in transit
- Moulded handle for safe and secure carrying
- Moulded graduations for quick easy volume assessment
- Autoclavable at 121°C
- Caps on 10 & 20 litre carboys have moulded drill guides to aid installation of feed lines etc.

Product Code	Capacity (litres)	Thread size (mm)	Height x width (mm)	Pack qty.
BNP05B	5	45	270 x 220	1
BNP10B	10	80	360 x 280	1
BNP20B	20	80	420 x 350	1

 Aspirators can be found on pages 27-31.

 When autoclaving bottles always ensure the caps are completely loosened or removed to prevent accidental implosion.

## Bottles, carboy, heavy duty, polypropylene, spares

Product Code	Description	Pack qty.
CAP045/H	Spare cap for BNP05A/B - White	10
CGZ85PP	Spare cap for BNP10A/B & 20A/B	1



## Bottles, carboy, HDPE

- Large capacity bottles with screw cap
- Ideal for bulk storage or transport of liquids
- Fitted with carrying handle (except 5L carboy)
- Clear moulded graduations allowing quick and easy volume assessment
- Good resistance to chemical attack
- 5 & 10 Litre aspirators have moulded graduations in Litres and Gallons
- 5 & 10 Litre are octagonal. 25 & 50 Litre are round
- 25 & 50 Litre are suitable for food contact applications in accordance with EU and USA regulations

Product Code	Capacity (litres)	Neck I.D. (mm)	Overall height (mm)	Pack qty.
BGH022	5	49	330	1
BGH024	10	49	380	1
BGH026	25	80	580	1
BGH028	50	80	700	1

 Large aspirators can be found on pages 27-31.

## Bottles, carboy, square, HDPE

- Square shape saves space on benchtops and shelves
- Graduated body
- 5L version features 2 moulded handles for safe transportation
- Larger sizes have a carry handle

Product Code	Capacity (litres)	Base (mm)	Neck I.D. (mm)	Height (mm)	Pack qty.
BSH05B	5	165	40	325	1
BSH10B	10	210	40	365	1
BSH20B	20	262	50	465	1
BSH30B	30	305	65	525	1



## Bags, autoclave, blue, polypropylene

- Suitable for autoclaving biohazardous waste at 121°C
- Strong side weld construction (50µm)
- Printed with instructions for use and biohazard symbol
- Suitable for food contact applications in accordance with EU and USA regulations

Product Code	Size (mm)	Pack qty.
BWY200	300 x 608	100
BWY202	608 x 764	100
BWY204	608 x 896	100



## Bags, autoclave, high temperature, clear, polypropylene

- Suitable for autoclaving biohazardous waste at 135°C
- Strong side weld construction (50µm)
- Transparent and printed with instructions for use and biohazard symbol
- Suitable for food contact applications in accordance with EU and USA regulations

Product Code	Size (mm)	Pack qty.
BWY250	302 x 660	100
BWY252	433 x 632	100
BWY254	608 x 866	100



# Balers, baskets



## Balers, polypropylene



- Enables easy sampling of liquids
- A choice of 3 sampling volumes
- Supplied with 1m durable polypropylene coated steel handle
- Handle is screwed into beaker (13mm thread) via a welded coupling tube
- Units are autoclavable up to 121°C

Product Code	Capacity (ml)	Pack qty.
BWX016	250	1
BWX018	500	1
BWX020	1000	1



## Baskets, low form, polypropylene



- Strong lightweight rectangular basket
- Suitable for use as a draining / autoclave basket or for general storage
- Units stack when not in use to save space
- Good chemical resistance
- Autoclavable to 121°C

Product Code	l x w x h (mm)	Pack qty.
TWR200	400 x 300 x 100	1



## Baskets, with hinged lid, polypropylene



- Autoclavable at 121°C
- Ideal for sterilising test tubes
- Useful for storage in the laboratory
- Stackable space saving design

Product Code	l x w x h (mm)	Pack qty.
BWK004	143 x 120 x 109	1
BWK006	167 x 167 x 155	1
BWK009	225 x 225 x 230	1

**PYREX<sup>®</sup>**  
**100**  
1915 - 2015

trusted by  
scientists for  
100 years



For one hundred years PYREX has been a leading laboratory glassware brand in science. SciLabware is delighted to celebrate the 100th anniversary of the PYREX brand.

First introduced in 1915 the PYREX brand quickly established an enduring reputation for performance, reliability and safety.

SciLabware is proud of the contribution that PYREX laboratory products have made to science during the last century, as we look towards supporting our customers for many years to come.

## Beakers, low form, Griffin

**PYREX®**

- Complies with ISO 3819 and DIN 12331
- Manufactured from Pyrex® borosilicate glass
- Excellent thermal performance
- High resistance to chemical attack
- Printed with Trace Code for downloadable batch certificate
- Batch certificate available to download from [www.scilabware.com](http://www.scilabware.com)
- White graduations and marking spot



Product Code	Capacity (ml)	Height (mm)	O.D. (mm)	Pack qty.
1000/03M	5	30	22	10
1000/05M	10	35	26	10
1000/11M	25	50	34	10
1000/02M	50	60	42	10
1000/04D	100	70	50	10
1000/06D	150	80	60	10
1000/10D	250	95	70	10
1000/14D	400	110	80	10
1000/18D	600	125	90	10
1000/20D	800	135	100	10
1000/22D	1000	145	105	10
1000/28D	2000	185	130	10
1000/30D	3000	210	150	4
1000/34D	5000	270	170	1
1000/38D	10000	350	217	1



1000/38D is supplementary to ISO range. Graduations are approximate.



The thicker walls of Pyrex® 5 and 10 litre Beakers mean that care must be taken when heating and cooling.

## Beakers, low form, Griffin, heavy duty

PYREX®

- Mechanically stronger than standard beakers
- Designed for longer life and increased user safety
- Reinforced rims and spout, less prone to breakage during washing etc.
- Thicker walls and heavier bases
- Manufactured from Pyrex® borosilicate glass
- White graduations and marking spot

Product Code	Capacity (ml)	Height (mm)	O.D. (mm)	Pack qty.
1003-150	150	89	57	12
1003-250	250	90	68	12
1003-400	400	110	77	12
1003-600	600	124	90	6
1003-1L	1000	156	108	6
1003-2L	2000	179	131	4
1003-3L	3000	230	170	1
1003-4L	4000	250	160	1
1003-5L	5000	300	180	1

 Graduations are approximate. For advice on the care and use of Pyrex® glassware, please refer to the technical information section.

 The thicker walls of Pyrex® Heavy Duty Beakers mean that care must be taken when heating and cooling.



## Beakers, tall form, Berzelius

PYREX®

- Complies with ISO 3819 and DIN 12331
- Manufactured from Pyrex® borosilicate glass
- Printed with Trace Code for downloadable batch certificate
- Batch certificate available to download from [www.scilabware.com](http://www.scilabware.com)
- Tall form with spout
- White graduations and marking spot

Product Code	Capacity (ml)	Height (mm)	O.D. (mm)	Pack qty.
1015/02M	50	70	38	10
1015/04D	100	80	48	10
1015/06D	150	95	54	10
1015/10D	250	120	60	10
1015/14D	400	130	70	10
1015/18D	600	150	80	10
1015/22D	1000	180	95	10
1015/26D	2000	240	120	10

 Graduations are approximate.



# Beakers

New



**i** Graduations are approximate.

**!** The thicker walls of Pyrex® Heavy Duty Beakers mean that care must be taken when heating and cooling.

## Beakers, tall form, Berzelius, heavy duty

PYREX®

- Mechanically stronger than standard beakers
- Designed for longer life and increased user safety
- Reinforced rims and spout, less prone to breakage during washing etc.
- Thicker walls and heavier bases
- Manufactured from Pyrex® borosilicate glass
- Printed with Trace Code for downloadable batch certificate
- Batch certificate available to download from [www.scilabware.com](http://www.scilabware.com)
- White graduations and marking spot

Product Code	Capacity (ml)	Height (mm)	O.D. (mm)	Pack qty.
1004-150	150	95	54	10
1004-250	250	120	60	10
1004-600	600	150	80	10



## Beakers, conical form, Phillips

PYREX®

- Conical shape (Phillips pattern) with spout
- Manufactured from Pyrex® borosilicate glass
- Excellent thermal performance and chemical resistance

Product Code	Capacity (ml)	Height (mm)	Base diam. (mm)	Top diam. (mm)	Pack qty.
1020/06D	250	105	68.0	52	10
1020/16D	500	142	86.0	59	10



## Beakers, jacketed

PYREX®

- Useful for maintaining samples at a constant temperature
- With integral jacket through which a temperature controlling medium can be circulated
- Manufactured from heat resistant Pyrex® borosilicate glass
- With PTFE screwthread connectors for simple and safe connection of 9mm bore tubing

Product Code	Inner chamber capacity (ml)	O.D. (mm)	Diam. int (mm)	Height int (mm)	Height total (mm)	Pack qty.
1025/10SC	250	70	52	130	138	1
1025/18SC	600	95	70	170	180	1
1025/22SC	1000	110	80	215	235	1
1025/28SC	2000	130	106	260	280	1

**i** For spare PTFE screwthread connectors, please refer to page 104. A range of jacketed reaction flasks are featured on page 159.

## Beakers, straight sided, printed graduations, polypropylene



- Complies with ISO 7056
- Popular classic Azlon beakers
- Ideal for general laboratory use - straight stable shape
- Polypropylene material - good chemical resistance
- Can withstand temperatures up to 121°C and therefore autoclavable
- Graduations are clearly printed in indelible solvent resistant ink



Product Code	Capacity (ml)	Grads. (ml)	O.D. (mm)	Height (mm)	Pack qty.
BDA208P	10	1	32	32	10
BDA212P	25	2	42	40	10
BDA218P	50	5	51	51	10
BDA224P	100	10	62	62	10
BDA230P	250	25	82	82	10
BDA234P	400	50	94	95	10
BDA236P	500	50	93	101	10
BDA238P	600	50	106	107	5
BDA240P	1000	100	127	126	5
BDA242P	2000	200	158	160	1

 BDA234P and BDA238P are supplementary to ISO 7056. Cleaning temperatures below 60°C are recommended to preserve marks and inscriptions.

## Beakers, straight sided, printed graduations, polypropylene, sets



- Set of popular classic Azlon beakers
- Ideal for general laboratory use - straight stable shape
- Polypropylene material - good chemical resistance
- Can withstand temperatures up to 121°C and therefore autoclavable
- Graduations are clearly printed in indelible solvent resistant ink

Product Code	Description	Pack qty.
BDA218MES	Set of 3 beakers (50, 100 & 250ml)	1
BDA1198	Set of 3 beakers (500, 1000 & 2000ml)	1
BDA1199	Set of 5 beakers (10, 25, 50, 100 & 250ml)	1
BDA1200	Set of 8 beakers (10, 25, 50, 100, 250, 500, 1000 & 2000ml)	1
BDA300P	Set of 10 beakers (One of each size)	1



# Beakers



## Beakers, tapered, printed graduations, polypropylene



- Tapered stacking style - space saving and easy to handle
- Complies with ISO 7056
- High clarity polypropylene - autoclavable at 121°C with good chemical resistance
- Crisp, blue, easy to read indelible graduations
- Precise non drip pouring spouts

Product Code	Capacity (ml)	Grads. (ml)	Rim diam. (mm)	Height (mm)	Pack qty.
BPB0025P	25	5	41.5	51	10
BPB0050P	50	10	50.5	61	10
BPB0100P	100	20	61.5	73	10
BPB0250P	250	50	80.5	96	10
BPB0400P	400	50	92.5	111	10
BPB0500P	500	50	102.5	121	10
BPB0600P	600	50	104.0	126	5
BPB1000P	1000	100	120.0	148	5
BPB2000P	2000	200	163.0	188	1
BPB3000P	3000	200	172.0	214	1
BPB5000P	5000	500	230.0	250	1



*BPB0400P, BPB0600P and BPB3000P are supplementary to ISO range.*

## Beakers, tapered, moulded graduations, polypropylene



- Tapered Beaker allowing ease of handling
- Comply to ISO 7056
- Autoclavable at 121°C with good chemical resistance
- Stackable space saving design
- Made from high clarity polypropylene
- Durable and economical with clear, moulded permanent graduations
- Precise non drip pouring spouts



Product Code	Capacity (ml)	Grads. (ml)	Rim diam. (mm)	Height (mm)	Pack qty.
BPM0025P	25	5	41.5	51	10
BPM0050P	50	10	50.5	61	10
BPM0100P	100	20	61.5	73	10
BPM0250P	250	50	80.5	96	10
BPM0400P	400	50	92.5	111	10
BPM0500P	500	50	102.5	121	10
BPM0600P	600	50	104.0	126	5
BPM1000P	1000	100	120.0	148	5
BPM2000P	2000	200	163.0	188	1
BPM3000P	3000	200	172.0	214	1
BPM5000P	5000	500	230.0	250	1

 *BPM0400P, BPM0600P and BPM3000P are supplementary to ISO range.*



## Beakers, low form, Griffin, printed graduations, polypropylene



- Complies with ISO 7056
- Traditional beaker shape
- Ideal for general laboratory use
- Polypropylene material - good chemical resistance
- Can withstand temperatures up to 121°C and therefore autoclavable
- Graduations are clearly printed in indelible solvent resistant ink

Product Code	Capacity (ml)	Grads. (ml)	O.D. (mm)	Height (mm)	Pack qty.
BDC208P	10	2	27	36	12
BDC212P	25	5	35	50	12
BDC218P	50	10	42	60	12
BDC224P	100	10	51	69	12
BDC230P	250	25	71	94	6
BDC234P	400	50	80	111	6
BDC236P	500	50	87	117	6
BDC238P	600	50	95	125	6
BDC240P	1000	100	107	148	6
BDC242P	2000	200	131	187	6

**i** BDC234P and BDC238P are supplementary to ISO 7056

**!** Cleaning temperatures below 60°C are recommended to preserve marks and inscriptions

**New**



## Beakers, low form, Griffin, printed graduations, PMP (TPX)



- Complies with ISO 7056
- Traditional beaker shape
- Ideal for general laboratory use
- Suitable for food contact applications in accordance with USA regulations
- PMP material - good chemical resistance
- Can withstand temperatures up to 150°C and therefore autoclavable
- Graduations are clearly printed in indelible solvent resistant ink

Product Code	Capacity (ml)	Grads. (ml)	O.D. (mm)	Height (mm)	Pack qty.
BDD312P	25	5	35	50	12
BDD318P	50	10	42	60	12
BDD324P	100	10	51	69	12
BDD330P	250	25	71	94	6
BDD334P	400	50	80	111	6
BDD336P	500	50	87	117	6
BDD338P	600	50	95	125	6
BDD340P	1000	100	107	148	6
BDD342P	2000	200	131	187	6

**i** BDD334P and BDD338P are supplementary to ISO 7056

**!** Cleaning temperatures below 60°C are recommended to preserve marks and inscriptions

## Beakers, straight sided, PTFE



- Opaque PTFE beakers
- Suitable for food contact applications in accordance with USA regulations
- Manufactured from USP Class VI grade PTFE
- Rigid and non-porous with a smooth surface
- Resistant to all chemicals except molten alkali metals and fluorine
- Are efficient substitutes for platinum
- Can withstand temperatures up to 260°C

Product Code	Capacity (ml)	O.D. (mm)	Height (mm)	Pack qty.
BWN008	10	24	33	1
BWN012	25	32	47	1
BWN018	50	43	60	1
BWN024	100	54	68	1
BWN028	150	59	75	1
BWN030	250	66	97	1
BWN035	400	80	106	1
BWN036	500	80	125	1



**NEW**



For information on food safety, please refer to the technical section.



It is NOT advisable to use PTFE beakers on a hotplate as fluorine can be emitted at high temperatures.

## Disposal bins, cardboard & LDPE



- Self assembly rigid boxes for safe disposal of broken glass
- Glass is safely held in strong leak-proof and puncture resistant LDPE liner
- Lid has an integral waste flap for easy use and has a sealing feature for use when full
- Boxes are clearly printed with instructions for use

Product Code	Description	Dimensions (w x d x h) (cm)	Pack qty.
DBG001P	Glass bin floor standing	30 x 30 x 70	6
DBG002P	Glass bin bench top	23 x 23 x 26.5	6



## Incineration bins, cardboard & LDPE



- Self-assembly rigid boxes for the collection and incineration of biohazardous waste
- Waste is safely held in strong leak-proof and puncture resistant LDPE liner
- Lid has an integral waste flap for easy use and has a sealing feature for use when full
- Boxes are clearly printed with instructions for use

Product Code	Description	Dimensions (w x d x h) (cm)	Pack qty.
DBH001P	Incineration bin floor standing	30 x 30 x 70	6
DBH002P	Incineration bin bench top	20 x 20 x 25	6



New



## Bottles, media-lab, wide mouth, with cap and pouring ring

PYREX®

- Bottles complete with polypropylene screwcap and drip-free pouring ring
- Manufactured from Pyrex® borosilicate glass with proven temperature and chemical resistance qualities
- GLS 80® screwthread provides increased access compared to GL 45 bottles aiding filling and pouring
- Ideal for use with viscous liquids, pastes, powders, granules and larger solids
- Printed with Trace Code for downloadable batch certificate
- Batch certificate available to download from [www.scilabware.com](http://www.scilabware.com)
- White enamel graduations and marking spot
- Autoclavable
- Screwcaps and pouring rings can withstand temperatures up to 140°C

Product Code	Capacity (ml)	Bottle height (mm)	Body diam. (mm)	Thread size (mm)	Pack qty.
1523/06	250	105	95	GLS 80	10
1523/08	500	152	101	GLS 80	10
1523/10	1000	222	101	GLS 80	10
1523/12	2000	252	136	GLS 80	10
1523/14	3500	271	160	GLS 80	1
1523/16	5000	314	182	GLS 80	1
1523/18	10000	389	227	GLS 80	1
1523/22	20000	484	288	GLS 80	1



Never autoclave bottles with a fully tightened screwcap. Always slacken off. Failure to follow this procedure can lead to breakage of the bottle.



### Bottles, media-lab, wide mouth, without cap or pouring ring

PYREX®

New

- Bottles without screwcap or pouring ring
- Manufactured from Pyrex® borosilicate glass with proven temperature and chemical resistance qualities
- GLS 80® screwthread provides increased access compared to GL 45 bottles aiding filling and pouring
- Ideal for use with viscous liquids, pastes, powders, granules and larger solids
- Printed with Trace Code for downloadable batch certificate
- Batch certificate available to download from [www.scilabware.com](http://www.scilabware.com)
- White enamel graduations and marking spot
- Autoclavable
- Screwcaps and pouring rings are available separately



Product Code	Capacity (ml)	Bottle height (mm)	Body diam. (mm)	Thread size (mm)	Pack qty.
1524/06	250	105	95	GLS 80	10
1524/08	500	152	101	GLS 80	10
1524/10	1000	222	101	GLS 80	10
1524/12	2000	252	136	GLS 80	10
1524/14	3500	271	160	GLS 80	1
1524/16	5000	314	182	GLS 80	1
1524/18	10000	389	227	GLS 80	1
1524/22	20000	484	288	GLS 80	1

## CUSTOM GLASSWARE MANUFACTURE

- Free quotation without obligation
- Highest quality guaranteed
- All enquiries welcome

Email: [customglass@scilabware.com](mailto:customglass@scilabware.com)



ROTAFLO®

PYREX®

MBL®

## Bottles, media-lab, with cap and pouring ring

PYREX®

- Bottles complete with polypropylene cap and drip-free pouring ring
- Complies with ISO 4796
- Printed with Trace Code for downloadable batch certificate
- Batch certificate available to download from [www.scilabware.com](http://www.scilabware.com)
- Ideal for mixing and storage of culture medium
- Sloping shoulders for smooth pouring action
- White graduations and marking spot
- Manufactured from temperature and chemically resistant borosilicate glass
- For use up to 140°C



Product Code	Capacity (ml)	Bottle height (mm)	Body diam. (mm)	Thread size (mm)	Pack qty.	
1516/01D	25	70	36	GL 25	10	
1516/02D	50	88	46	GL 32	10	
1516/04D	100	100	56	GL 45	10	
1516/05D	150	105	62	GL 45	10	<b>NEW</b>
1516/06D	250	138	70	GL 45	10	
1516/08D	500	176	86	GL 45	10	
1516/09D	750	203	95	GL 45	10	<b>NEW</b>
1516/10D	1000	225	101	GL 45	10	
1516/12D	2000	260	136	GL 45	10	
1516/14D	3500	295	160	GL 45	1	<b>NEW</b>
1516/16D	5000	330	181	GL 45	1	
1516/18D	10000	410	227	GL 45	1	
1516/20D	15000	465	258	GL 45	1	
1516/22D	20000	510	300	GL 45	1	



Further information on 'Trace Codes' is detailed in the technical information section. The 25 ml size bottle features a glass lip and does not require a pouring ring.



Never autoclave bottles with a fully tightened screwcap. Always slacken off. Failure to follow this procedure can lead to breakage of the bottle.

### Bottles, media-lab, with high temp cap and pouring ring

- Bottles complete with thermoplastic polyester cap, PTFE sealing disc and pouring ring
- Complies with ISO 4796
- Printed with Trace Code for downloadable batch certificate
- Batch certificate available to download from [www.scilabware.com](http://www.scilabware.com)
- Withstands hot air sterilisation up to 180°C
- PTFE sealing disc resists chemical attack
- White graduations and marking spot
- Manufactured from temperature and chemically resistant borosilicate glass

Product Code	Capacity (ml)	Bottle height (mm)	Body diam. (mm)	Thread size (mm)	Pack qty.
1516/01RED	25	70	36	GL 25	10
1516/02RED	50	88	46	GL 32	10
1516/04RED	100	100	56	GL 45	10
1516/06RED	250	138	70	GL 45	10
1516/08RED	500	176	86	GL 45	10
1516/10RED	1000	225	101	GL 45	10
1516/12RED	2000	260	136	GL 45	10
S/31516/16D	5000	330	181	GL 45	1
S/31516/18D	10000	410	227	GL 45	1

PYREX®



**i** The 25 ml size bottle features a glass lip and does not require a pouring ring.

### Bottles, media-lab, without cap or pouring ring

- Bottles only. Supplied without cap or pouring ring
- Complies with ISO 4796
- Printed with Trace Code for downloadable batch certificate
- Batch certificate available to download from [www.scilabware.com](http://www.scilabware.com)
- Sloping shoulders for smooth pouring action
- White graduations and marking spot
- Manufactured from temperature and chemically resistant borosilicate glass

Product Code	Capacity (ml)	Bottle height (mm)	Body diam. (mm)	Thread size (mm)	Pack qty.
1517/01	25	70	36	GL 25	10
1517/02	50	88	46	GL 32	10
1517/04	100	100	56	GL 45	10
1517/05	150	105	62	GL 45	10
1517/06	250	138	70	GL 45	10
1517/08	500	176	86	GL 45	10
1517/09	750	203	95	GL 45	10
1517/10	1000	225	101	GL 45	10
1517/12	2000	260	136	GL 45	10
1517/14	3500	295	160	GL 45	1
1517/16	5000	330	181	GL 45	1
1517/18	10000	410	227	GL 45	1
1517/20	15000	465	258	GL 45	1
1517/22	20000	510	300	GL 45	1

PYREX®



**i** Choice of caps and pouring rings available separately on pages 49 and 50. The 25 ml size bottle features a glass lip and does not require a pouring ring.

**!** Never autoclave bottles with a fully tightened screwcap. Always slacken off. Failure to follow this procedure can lead to breakage of the bottle.





## Bottles, media-lab, plastic-coated

**PYREX®**

- Bottles only. Supplied without cap or pouring ring
- Complies with ISO 4796
- Borosilicate glass with clear PU plastic coating to provide added protection against mechanical breakage
- Reduces the hazard of flying glass and liquid splashes in the event of breakage
- Printed with Trace Code for downloadable batch certificate
- Batch certificate available to download from [www.scilabware.com](http://www.scilabware.com)
- Coating withstands steam sterilisation up to 135°C

Product Code	Capacity (ml)	Bottle height (mm)	Body diam. (mm)	Thread size (mm)	Pack qty.
1518/04	100	100	56	GL 45	10
1518/06	250	138	70	GL 45	10
1518/08	500	176	86	GL 45	10
1518/10	1000	225	101	GL 45	10
1518/12	2000	260	136	GL 45	10
1518/16	5000	330	181	GL 45	1
1518/18	10000	410	227	GL 45	1

**i** For further details on plastic coated-bottles, please see the technical information section.



## Bottles, media-lab, amber glass

**PYREX®**

- Bottles only. Supplied without cap or pouring ring
- Complies with ISO 4796
- Manufactured from amber-coated borosilicate glass
- UV absorbent up to 500nm
- Ideal for storage of light sensitive materials
- Printed with Trace Code for downloadable batch certificate
- Batch certificate available to download from [www.scilabware.com](http://www.scilabware.com)

Product Code	Capacity (ml)	Bottle height (mm)	Body diam. (mm)	Thread size (mm)	Pack qty.
1519/01	25	70	36	GL 25	10
1519/02	50	88	46	GL 32	10
1519/04	100	100	56	GL 45	10
1519/06	250	138	70	GL 45	10
1519/08	500	176	86	GL 45	10
1519/10	1000	225	101	GL 45	10
1519/12	2000	260	136	GL 45	10
1519/16	5000	330	181	GL 45	1
1519/18	10000	410	227	GL 45	1

**i** 1519: Amber media bottles also available with polypropylene or High temperature cap and pouring ring. Please contact SciLabware customer service department for details.  
The 25 ml size bottle features a glass lip and does not require a pouring ring.

## Bottles, media-lab, square shape

PYREX®

- Square shape allows closer stacking in water baths or on shelves
- Up to 20% saving of space compared to round bottles
- Bottle complete with polypropylene cap and pouring ring
- For use up to 140°C
- Printed with Trace Code for downloadable batch certificate
- Batch certificate available to download from [www.scilabware.com](http://www.scilabware.com)

Product Code	Capacity (ml)	Bottle height (mm)	Body diam. (mm)	Thread size (mm)	Pack qty.
1520/04D	100	109	50	GL 32	10
1520/06D	250	143	64	GL 45	10
1520/08D	500	181	78	GL 45	10
1520/10D	1000	222	94	GL 45	10



 Further information on 'trace codes' is detailed in the technical information section.

## Screwcaps for media-lab bottles

PYREX®

- For use with 1516, 1517, 1518, 1519, 1520, 1523 and 1524 series bottles
- Polypropylene plug seal cap ideal for media preparation work
- Autoclavable up to 140°C
- Available in choice of 4 colours for easy identification of samples

Product Code	Thread size (mm)	Colour	Pack qty.
4506/25D	GL 25	Light blue	10
4506/32D	GL 32	Light blue	10
4506/45D	GL 45	Light blue	10
4506/45E	GL 45	Green	10
4506/45F	GL 45	Yellow	10
4506/45G	GL 45	Grey	10
4506/80D	GLS 80	Light blue	10



# Bottles



**i** The cap may discolour when used at the maximum temperature of 180°C, however this does not affect performance.

## Screwcaps for media-lab bottles, high temperature **PYREX®**

- For use with 1516, 1517, 1518, 1519 and 1520 series bottles
- Ideal for applications involving high temperatures or aggressive chemicals
- Red thermoplastic polyester cap with natural coloured PTFE faced sealing disc
- Withstands hot air sterilisation up to 180°C
- PTFE sealing disc resists chemical attack

Product Code	Thread size (mm)	Colour	Description	Pack qty.
4526/25D	GL 25	Red	Cap with sealing disc	10
4526/32D	GL 32	Red	Cap with sealing disc	10
4526/45D	GL 45	Red	Cap with sealing disc	10
4546/25	GL 25	Natural	Spare sealing disc	10
4546/32	GL 32	Natural	Spare sealing disc	10
4546/45	GL 45	Natural	Spare sealing disc	10



## Pouring rings for media-lab bottles

**PYREX®**

- For use with 1516, 1517, 1518, 1519 1520, 1523 and 1524 series bottles
- Ensures drip-free pouring
- Clear polypropylene pouring ring
- Withstands autoclaving up to 140°C

Product Code	Thread size (mm)	Colour	Pack qty.
4516/32D	GL 32	Clear	10
4516/45D	GL 45	Clear	10
4516/80D	GLS 80	Clear	10



## Pouring rings for media-lab bottles, high temperature

**PYREX®**

- For use with 1516, 1517, 1518, 1519 and 1520 series bottles
- Ideal for applications involving high temperatures
- Red coloured ethylene-tetrafluoroethylene pouring ring
- Withstands hot air sterilisation up to 180°C

Product Code	Thread size (mm)	Colour	Pack qty.
4536/32D	GL 32	Red	10
4536/45D	GL 45	Red	10

## Screwcaps, connection system

**PYREX®**

- Connection system screwcaps for Pyrex® GL 45 media-lab bottles facilitate the transfer of liquids within a closed and sterile system, ideal for chemistry and biotechnology laboratories
- Begin by choosing a two or three port connection system screwcap, add tubing adapters and inserts to attach tubing
- Four different tubing diameters can be accommodated (OD; 1.6mm, 3.0mm, 3.2mm and 6.0mm)
- The additional pressure compensation set that includes a membrane filter with 0.2µm sized pores permits sterile pressure equalisation
- Unused ports can be sealed with a blanking cap (4538/04)
- Components are fully interchangeable and compatible with both two and three port screwcaps
- Screwcaps and components are temperature resistance to 140°C
- Autoclavable and dishwasher safe

Product Code	Description	Thread size (mm)	Pack qty.
4537/02	GL45 screwcap with two GL14 ports	GL 45	2
4537/04	GL45 screwcap with three GL14 ports	GL 45	2
4538/02	GL14 screwcap with tubing outlet	GL 14	2
4538/04	GL14 screwcap with PTFE coated insert	GL 14	2
4539/02	Insert for GL14 screwcap with tubing outlet, 1.6mm ID		1
4539/04	Insert for GL14 screwcap with tubing outlet, 3.0mm ID		1
4539/06	Insert for GL14 screwcap with tubing outlet, 3.2mm ID		1
4539/08	Insert for GL14 screwcap with tubing outlet, 6.0mm ID		1
4539/10	Pressure compensation set for GL14 ports (incl. 0.2µm syringe filter)	GL 14	1
4541/02	Spare 0.2µm syringe filter for pressure compensation set		2



# Bottles

New



## Screwcap, twin hose connector

PYREX®

- Manufactured from Polypropylene with tubing connectors that allows GL 45 media-lab bottles to be connected with flexible tubing
- Suitable for use with soft elastic tubing that has an inner diameter of 6 – 9mm (such as Viton®, Tygon® or other silicon tubing)
- Bottle contents can be kept sterile with an optional venting connector with a 0.2µm syringe filter
- The top angled connectors prevent kinks in the tubing
- Screwcap can be removed without the need to remove the tubing as the centre rotates freely
- Temperature resistance to 140°C
- Autoclavable
- Dishwasher safe

Product Code	Description	Thread size (mm)	Pack qty.
4537/06	Twin hose connector screwcap with GL45 screwthread	GL 45	2
4541/04	0.2µm filter with hose connector adapter		2

New



## Screwcap, membrane

PYREX®

- Polypropylene screwcap with integral 0.2µm PTFE membrane
- Gas permeable membrane permits pressure equalisation allowing glassware to be sterilised using an autoclave with the screwcap fastened
- Provides a tight seal that prevents the ingress of liquids or solids
- Ideal for aerobic microbiology and cell culture
- Suitable for storage and transport of gas generating media
- Autoclavable
- Temperature resistant to 140°C

Product Code	Thread size (mm)	Colour	Pack qty.
4507/45D	GL 45	Light blue	5



Compatible with 1516, 1517, 1518, 1519 and 1520 series bottles and 1139/10 Fernbach flasks

## Screwcap, bottle pourer

PYREX®

- Manufactured from white PTFE and blue polypropylene
- Aids the dispensing of liquids from bottles and flasks with a GL 45 screwthread
- Provides greater control of flow with large capacity bottles that can be difficult to handle
- Supplied complete with venting tube and attached PTFE cap
- Temperature resistance to 140°C
- Autoclavable
- Dishwasher safe

Product Code	Thread size (mm)	Colour	Pack qty.
4542/02	GL 45	Light blue	1



## Bottles, reagent, screwcap

PYREX®

- Complies with ISO 4796-1
- Ideal for storage of reagents, analytical standards and culture media etc.
- Manufactured from Pyrex® borosilicate glass
- Excellent resistance to chemical attack and high temperatures
- Supplied with PBT screwcaps having a PTFE faced sealing disc
- Withstands hot air sterilisation up to 180°C
- Autoclavable
- White graduations and marking spot

Product Code	Capacity (ml)	Bottle height (mm)	Body diam. (mm)	Thread size (mm)	Pack qty.
1515/01D	25	65	35	SVL 20	10
1515/02D	50	80	43	SVL 25	10
1515/04D	100	105	53	SVL 25	10
1515/06D	250	135	66	SVL 30	10
1515/08D	500	175	81	SVL 30	10
1515/10D	1000	215	101	SVL 42	10
1515/12D	2000	245	136	SVL 60	10
1515/16D	5000	324	181	SVL 60	1
1515/18D	10000	395	227	SVL 60	1
1515/20D	15000	460	258	SVL 60	1
1515/22D	20000	502	288	SVL 60	1



Never autoclave bottles with a fully tightened cap. Always slacken off. Failure to follow this procedure can lead to breakage of the bottle.



## Screwcaps for 1515: series reagent bottles

**PYREX®**

- PBT cap with PTFE faced sealing disc for chemical resistance
- Withstands hot air sterilisation up to 180°C
- Autoclavable

Product Code	Description	Thread size (mm)	Pack qty.
4503/20	Cap with insert	SVL 20	20
4503/25	Cap with insert	SVL 25	20
4503/30	Cap with insert	SVL 30	20
4503/42	Cap with insert	SVL 42	10
4503/60	Cap with insert	SVL 60	5
4513/20M	Spare insert	SVL 20	20
4513/25M	Spare insert	SVL 25	20
4513/30M	Spare insert	SVL 30	20
4513/42M	Spare insert	SVL 42	10
4513/60M	Spare insert	SVL 60	5



Insert is ethylene propylene with PTFE face for chemical resistance.



## Bottles, reagent, narrow neck, glass stopper

**PYREX®**

- Complies with ISO 4796-2
- Borosilicate glass with ground neck
- Supplied with solid glass stopper

Product Code	Capacity (ml)	Body diam. (mm)	Stopper size	Height with stopper (mm)	Pack qty.
1521/04D	100	54	14/15	106	10
1521/06D	250	73	19/26	143	10
1521/08D	500	89	24/29	175	10
1521/10D	1000	111	29/32	214	10
1521/12D	2000	138	29/32	262	10
1521/16D	5000	181	45/40	333	1
1521/18D	10000	227	60/46	414	1
1521/22D	20000	288	60/46	508	1



Spare glass stoppers are available on page 258.

## Bottles, reagent, narrow neck

PYREX®

- Complies with ISO 4796
- Borosilicate glass with unground neck
- For use with rubber stoppers (not supplied)

Product Code	Capacity (ml)	Body diam. (mm)	Neck I.D. at top (mm)	Bottle height (mm)	Pack qty.
1526/04D	100	54	13	95	10
1526/06D	250	73	18	131	10
1526/08D	500	89	23	163	10
1526/10D	1000	111	28	200	10
1526/12D	2000	138	28	248	10
1526/16D	5000	187	44	315	1
1526/18D	10000	227	59	398	1
1526/20D	15000	258	59	460	1
1526/22D	20000	288	59	492	1



 1526/20D is supplementary to the ISO range.

## Bottles, reagent, soda-lime, clear

MBL®

- Complies with ISO 4796-2
- Clear soda-lime glass bottles with ground neck
- Supplied with polyethylene stoppers

Product Code	Capacity (ml)	Body diam. (mm)	Bottle height (mm)	Socket size	Pack qty.
SBC100	50	42	77	14/15	10
SBC102	100	52	103	14/23	10
SBC104	250	69	131	19/26	10
SBC106	500	85	163	24/29	10
SBC108	1000	107	199	29/32	10



 50ml bottle is supplied with 14/23 stopper



# Bottles

New



## Bottles, reagent, soda-lime, amber glass

MBL®

- Complies with ISO 4796-2
- Amber soda-lime glass bottles with ground neck
- UV absorbent up to 500nm
- Ideal for the storage of light sensitive materials
- Supplied with polyethylene stoppers

Product Code	Capacity (ml)	Body diam. (mm)	Bottle height (mm)	Socket size	Pack qty.
SBA100	50	42	77	14/15	10
SBA102	100	52	103	14/23	10
SBA104	250	69	131	19/26	10
SBA106	500	85	163	24/29	10
SBA108	1000	107	199	29/32	10

 50ml bottle is supplied with 14/23 stopper

New



## Dropping pipettes for soda-lime reagent bottles

MBL®

- Manufactured from clear soda-lime glass
- With integral ground glass cone on pipette
- Supplied with rubber teats
- Bottles available separately

Product Code	Description	To fit bottle	Joint size	Pack qty.
SBD050	Dropping pipettes with silicone teat	50ml bottle	14/15	5
SBD100	Dropping pipettes with silicone teat	100ml bottle	14/23	5
SBD250	Dropping pipettes with silicone teat	250ml bottle	19/26	5

## Spare teats for dropping pipettes

Product Code	Description	Pack qty.
SBT100	Spare silicone teats for dropping pipettes	100

## Bottles, density, adjusted

**MBL®**

- Complies with ISO 3507, Gay-Lussac type
- Adjusted ready for use - with the exact volume engraved on the bottle
- Supplied with individual 10/19 sized capillary stoppers which are numbered and matched with the bottle
- Manufactured from borosilicate glass

Product Code	Nom. capacity (ml)	Tol. (+/- ml)	Pack qty.
BRE000	10	1.00	2
BRE002	25	2.00	2
BRE004	50	3.00	2
BRE006	100	3.00	2



## Bottles, roller

**PYREX®**

- Ideal for cell culture work
- Pyrex® borosilicate glass, specially selected for surface finish and optical clarity
- Wide neck for easy cell harvesting
- Non-toxic polypropylene screwcap
- Autoclavable up to 121°C
- Fits standard roller apparatus
- Can be used with membrane screwcaps to allow gaseous transfer

Product Code	Overall length (mm)	Body O.D. (mm)	Effective length (mm)	Effective growth area (cm <sup>2</sup> )	Overall growth area (cm <sup>2</sup> )	Pack qty.
1528/02	284	110	210	670	820	2



*Never autoclave bottles with a fully tightened screwcap. Always slacken off. Failure to follow this procedure can lead to breakage of the bottle.*

# Bottles



## Bottles, dropping

**MBL®**

- Borosilicate glass bottle and pipette.
- Polypropylene stopper
- Pipette fitted with vinyl rubber teat

Product Code	Capacity (ml)	O.D. (mm)	Bottle height (mm)	Pack qty.
BRF056	100	54	104	10

**New**



## Bottles, square, narrow neck, polycarbonate

*A Azlon*

- Highly transparent polycarbonate media bottles with linerless polypropylene cap
- Suitable for repeated sterilisation by autoclaving at 121°C
- Ideal for the preparation and storage of biological media, reagents and aqueous solutions
- Leakproof
- Practical square design for economic use of space
- Heavy duty and durable in use

Product Code	Capacity (ml)	Base x height (mm)	Neck I.D. (mm)	Pack qty.
BSC0250	250	59 x 139	28	24
BSC0500	500	73 x 172	28	12
BSC1000	1000	92 x 213	28	12
BSC2000	2000	115 x 266	40	6



*Recommended for up to 10 autoclave cycles at 121°C*

### Bottles, Boston round, narrow neck, polycarbonate



- Highly transparent polycarbonate media bottles with linerless polypropylene cap
- Suitable for repeated sterilisation by autoclaving at 121°C
- Ideal for the preparation and storage of biological media, reagents and aqueous solutions
- Leakproof
- Classic round design
- Heavy duty and durable in use

Product Code	Capacity (ml)	Height (mm)	O.D. (mm)	Neck I.D. (mm)	Pack qty.
BRC0500	500	175	81	28	12
BRC1000	1000	216	97	28	12

 Recommended for up to 10 autoclave cycles at 121°C



### Bottles, vials, round, polycarbonate



- Highly transparent polycarbonate vials with coloured polypropylene cap
- Suitable for repeated sterilisation by autoclaving at 121°C
- Ideal for sampling, production and packaging of steam sterilised biological solutions
- Leakproof and shatterproof
- Withstands temperatures to -80°C

Product Code	Capacity (ml)	Height (mm)	O.D. (mm)	Neck I.D. (mm)	Pack qty.
BRC0005	5	52	22	14	100
BRC0010	10	62	24	14	100

 Recommended for up to 10 autoclave cycles at 121°C



New improved  
Azlon bottles



## Bottles, round, narrow neck, polypropylene



- Translucent, rigid polypropylene bottles with polypropylene screw caps
- Heavy duty and very durable in use
- Autoclavable at 121°C
- Suitable for food contact applications in accordance with EU and USA regulations
- Ideal for a wide range of liquid storage, media preparation and sampling applications
- Batch certificate available to download online
- Good general chemical resistance
- Bulk packs contain uncapped bottles and a pack of caps

Product Code	Capacity (ml)	Height (mm)	O.D. (mm)	Neck I.D. (mm)	Pack qty.	
BNP0030PN	30	66	33	13	10	
BNP0060PN	60	80	40	13	10	
BNP0100PN	100	89	50	18	10	
BNP0125PN	125	102	50	18	10	
BNP0150PN	150	116	50	18	10	
BNP0250P	250	129	62	18	10	
BNP0500P	500	167	73	21	10	
BNP1000P	1000	213	92	27	5	
BNP2000P	2000	240	121	27	5	
BNP0030BULK	30	66	32	13	1200	<b>NEW</b>
BNP0060BULK	60	80	40	13	800	<b>NEW</b>
BNP0100BULK	100	89	50	18	420	<b>NEW</b>
BNP0125BULK	125	102	50	18	350	<b>NEW</b>
BNP0150BULK	150	116	50	18	330	<b>NEW</b>
BNP0250BULK	250	129	60	18	200	<b>NEW</b>
BNP0500BULK	500	167	75	21	110	<b>NEW</b>
BNP1000BULK	1000	213	90	27	60	<b>NEW</b>
BNP2000BULK	2000	240	120	27	30	<b>NEW</b>



*When autoclaving bottles always ensure the caps are completely loosened or removed to prevent accidental implosion.*

## Bottles, round, narrow neck, HDPE



- Translucent, rigid HDPE bottles with polypropylene screw caps
- Lightweight but very durable in use
- Suitable for food contact applications in accordance with EU and USA regulations
- Batch certificate available to download online
- Ideal for storing a wide range of liquids
- Bulk packs contain uncapped bottles and a pack of caps

Product Code	Capacity (ml)	Height (mm)	O.D. (mm)	Neck I.D. (mm)	Pack qty.	
BNH0030PN	30	66	33	13	10	
BNH0060PN	60	80	40	13	10	
BNH0100PN	100	89	50	18	10	
BNH0125PN	125	102	50	18	10	
BNH0150PN	150	116	50	18	10	
BNH0250P	250	129	62	18	10	
BNH0500P	500	167	73	21	10	
BNH1000P	1000	213	92	27	5	
BNH2000P	2000	240	121	27	5	
BNH0030BULK	30	66	32	13	1200	<b>NEW</b>
BNH0060BULK	60	80	40	13	800	<b>NEW</b>
BNH0100BULK	100	89	50	18	420	<b>NEW</b>
BNH0125BULK	125	102	50	18	350	<b>NEW</b>
BNH0150BULK	150	116	50	18	330	<b>NEW</b>
BNH0250BULK	250	129	60	18	200	<b>NEW</b>
BNH0500BULK	500	167	75	21	110	<b>NEW</b>
BNH1000BULK	1000	213	90	27	60	<b>NEW</b>
BNH2000BULK	2000	240	120	27	30	<b>NEW</b>



For further information on chemical comparability see the chemical resistance chart in the technical section.

# Bottles

**New**



## Bottles, square, narrow neck, blue cap, HDPE



- Translucent HDPE bottles with linerless cap
- Ideal for general laboratory applications
- Heavy duty and durable in use
- Practical square design for economic use of space
- Good chemical resistance

Product Code	Capacity (ml)	Base x height (mm)	Neck I.D. (mm)	Pack qty.
BSR0100P	100	45 x 104	21	10
BSR0250P	250	56 x 130	21	10
BSR0500P	500	71 x 162	21	10
BSR1000P	1000	82 x 205	21	5
BSR0100BULK	100	45 x 104	21	520
BSR0250BULK	250	56 x 130	21	230
BSR0500BULK	500	71 x 162	21	150
BSR1000BULK	1000	82 x 205	21	72



## Bottles, round, slope shoulder, narrow neck, LDPE



- Flexible and translucent lightweight bottles
- Suitable for liquids
- Slope shoulder for smooth pouring
- Supplied capped with 28R4 polypropylene screw cap
- Neck I.D. 21mm

Product Code	Capacity (ml)	O.D. x height (mm)	Pack qty.
BGK930P	250	54 x 152	10
BGK936P	500	69 x 187	10
BGK940P	1000	84 x 246	5

## Bottles, round, narrow neck, LDPE



- Translucent, flexible LDPE bottles with polypropylene screw caps
- Heavy duty and very durable in use
- Ideal for a wide range of liquid storage applications
- Suitable for food contact applications in accordance with EU and USA regulations
- Batch certificate available to download online
- Bulk packs contain uncapped bottles and a pack of caps
- Good general chemical resistance

Product Code	Capacity (ml)	Height (mm)	O.D. (mm)	Neck I.D. (mm)	Pack qty.	
BNL0030PN	30	66	33	13	10	
BNL0060PN	60	80	40	13	10	
BNL0100PN	100	89	50	18	10	
BNL0125PN	125	102	50	18	10	
BNL0150PN	150	116	50	18	10	
BNL0250P	250	129	62	18	10	
BNL0500P	500	167	73	21	10	
BNL1000P	1000	213	92	27	5	
BNL2000P	2000	240	121	27	5	
BNL0030BULK	30	66	33	13	1200	<b>NEW</b>
BNL0060BULK	60	80	40	13	800	<b>NEW</b>
BNL0100BULK	100	89	50	18	420	<b>NEW</b>
BNL0125BULK	125	102	50	18	350	<b>NEW</b>
BNL0150BULK	150	116	50	18	330	<b>NEW</b>
BNL0250BULK	250	129	62	18	200	<b>NEW</b>
BNL0500BULK	500	167	73	21	110	<b>NEW</b>
BNL1000BULK	1000	213	92	27	60	<b>NEW</b>
BNL2000BULK	2000	240	121	27	30	<b>NEW</b>







## Bottles, dispensing, pivot nozzle, LDPE



- Round LDPE bottles fitted with a pivoting nozzle closure
- Nozzle retracts into cap to seal bottle
- Suitable for use as a dropping or wash bottle and excellent for dispensing gels
- Good resistance to chemical attack

Product Code	Capacity (ml)	O.D. (mm)	Height (mm)	Pack qty.
BGE514P	30	32	66	10
BGE520P	60	40	79	10
BGE528P	150	59	120	10
BGE530P	250	59	145	10
BGE536P	500	74	174	10



## Bottles, dispensing, spouted cap, LDPE



- Round LDPE bottles fitted with spouted dropper closure
- Closure features a captive sealing cap and can be cut to adjust flow rate
- Suitable for use as a dropping or dispensing bottle
- Good resistance to chemical attack

Product Code	Capacity (ml)	Diam. x height (mm)	Cap size	Pack qty.
BGE814PNC	30	32 x 103	28R4	10
BGE820PNC	60	39 x 118	28R4	10
BGE828PNC	150	50 x 144	28R4	10
BGE830PNC	250	60 x 168	28R4	10
BGE836PNC	500	73 x 198	28R4	10

## Bottles, round, wide neck, polypropylene

- Translucent, rigid polypropylene bottles with polypropylene screw caps
- Leak-proof, liner-less design
- Smooth inner contours for efficient pouring and ease of cleaning
- Heavy duty and very durable in use
- Suitable for food contact applications in accordance with EU and USA regulations
- Ideal for a wide range of liquid storage, media preparation and sampling applications
- Good chemical resistance
- Batch certificate available to download online
- Bulk packs contain uncapped bottles and a pack of caps
- Autoclavable at 121°C



Product Code	Capacity (ml)	Height (mm)	O.D. (mm)	Neck I.D. (mm)	Pack qty.	
BWP0030PN	30	70	32	22	10	
BWP0060PN	60	82	40	22	10	
BLP0100P	100	89	51	32	10	
BLP0125P	125	104	51	32	10	
BLP0150P	150	116	51	32	10	
BWP0250P	250	140	60	37	10	
BWP0500P	500	161	75	46	10	
BWP1000P	1000	205	90	55	5	
BWP2000P	2000	242	120	55	5	
BWP0030BULK	30	70	32	22	1200	<b>NEW</b>
BWP0060BULK	60	82	40	22	800	<b>NEW</b>
BLP0100BULK	100	89	51	32	420	<b>NEW</b>
BLP0125BULK	125	104	51	32	350	<b>NEW</b>
BLP0150BULK	150	116	51	32	330	<b>NEW</b>
BWP0250BULK	250	140	60	37	200	<b>NEW</b>
BWP0500BULK	500	161	75	46	110	<b>NEW</b>
BWP1000BULK	1000	205	90	55	60	<b>NEW</b>
BWP2000BULK	2000	242	120	55	30	<b>NEW</b>

 When autoclaving bottles always ensure the caps are completely loosened or removed to prevent accidental implosion.

**New  
Improved**



## Bottles, round, wide neck, amber, polypropylene



- Opaque, rigid amber polypropylene bottles with black polypropylene screw caps
- Leak-proof, liner-less design
- Ideal for a wide range of light sensitive liquid or solid storage
- Smooth inner contours for efficient pouring and ease of cleaning
- Heavy-duty and very durable in use
- Good general chemical resistance
- Autoclavable at 121°C

Product Code	Capacity (ml)	Height (mm)	O.D. (mm)	Neck I.D. (mm)	Pack qty.
BWP0060AP	60	82	40	22	10
BWP0150AP	150	116	51	32	10
BWP0250AP	250	140	60	37	10
BWP0500AP	500	161	75	46	10
BWP1000AP	1000	205	90	55	5
BWP2000AP	2000	242	120	55	5



*For information on chemical resistance please refer to the chemical resistance chart in the technical section.*



*When autoclaving bottles always ensure the caps are completely loosened or removed to prevent accidental implosion.*

## Bottles, graduated, write-on-panel, polypropylene



- Translucent polypropylene bottles with good chemical resistance
- Leak-proof, liner-less design
- Clear crisp printed graduations show millilitres and fluid ounces
- Printed with large white write-on-panel for easy labelling
- Smooth inner contour for efficient pouring and ease of cleaning
- Batch certificate available to download online
- Suitable for food contact applications in accordance with EU and USA regulations
- Ideal for both liquids and solids, perfect for microbiological sampling
- Autoclavable at 121°C

Product Code	Capacity (ml)	Height (mm)	O.D. (mm)	Neck I.D. (mm)	Pack qty.
BWP0060PGRAD	60	82	40	22	10
BLP0125PGRAD	125	104	51	32	10
BLP0150PGRAD	150	116	51	32	10
BWP0250PGRAD	250	141	60	37	10
BWP0500PGRAD	500	161	75	46	10
BWP1000PGRAD	1000	205	90	55	5

**NEW**



When autoclaving bottles always ensure the caps are completely loosened or removed to prevent accidental implosion.

## Bottles, round, powder, wide neck, HDPE



- Translucent rigid HDPE bottles with PVDC wadded polypropylene screw caps
- Ideal for storage of powders and other solids

Product Code	Capacity (ml)	Height (mm)	O.D. (mm)	Neck I.D. (mm)	Pack qty.
BGC428P	150	104	50	26	10
BGC430P	250	124	61	48	10
BGC432P	300	135	61	48	10
BGC436P	500	154	74	48	10
BGC440P	1000	190	98	72	5



**New improved  
Azlon bottles**



## Bottles, round, wide neck, HDPE



- Translucent, rigid HDPE bottles with polypropylene screw caps
- Leak-proof, liner-less design
- Smooth inner contours for efficient pouring and ease of cleaning
- Heavy duty and very durable in use
- Ideal for a wide range of liquid storage and sampling applications
- Suitable for food contact applications in accordance with EU and USA regulations
- Batch certificate available to download online
- Bulk packs contain uncapped bottles and a pack of caps
- Good chemical resistance

Product Code	Capacity (ml)	Height (mm)	O.D. (mm)	Neck I.D. (mm)	Pack qty.	
BWH0030PN	30	70	32	22	10	
BWH0060PN	60	82	40	22	10	
BLH0100P	100	89	51	32	10	
BLH0125P	125	104	51	32	10	
BLH0150P	150	116	51	32	10	
BWH0250PN	250	140	60	37	10	
BWH0500PN	500	161	75	46	10	
BWH1000PN	1000	205	90	55	5	
BWH2000P	2000	242	120	55	5	
BWH0030BULK	30	70	32	22	1200	<b>NEW</b>
BWH0060BULK	60	82	40	22	800	<b>NEW</b>
BLH0100BULK	100	89	51	32	420	<b>NEW</b>
BLH0125BULK	125	104	51	32	350	<b>NEW</b>
BLH0150BULK	150	116	51	32	330	<b>NEW</b>
BWH0250BULK	250	140	60	37	200	<b>NEW</b>
BWH0500BULK	500	161	75	46	110	<b>NEW</b>
BWH1000BULK	1000	205	90	55	60	<b>NEW</b>
BWH2000BULK	2000	242	120	55	30	<b>NEW</b>



*For information on food safety, please refer to the technical section.*

### Bottles, square, graduated, coloured cap, wide neck, HDPE



- Lightweight square bottles with plug seal and blue screw cap
- Moulded graduations for approximate volume measurement
- Ideal for powders
- Space saving design
- Neck I.D. 58mm

Product Code	Capacity (ml)	I x w x h (mm)	Pack qty.
BGE236P	500	75 x 75 x 120	10
BGE240P	1000	94 x 75 x 180	5
BGE242P	2000	108 x 92 x 235	5



### Bottles, square, graduated, wide neck, HDPE



- Heavy duty square bottles with plug seal and screw cap
- Easy to grip caps have toggle for tamper evident wire attachment to neck
- Moulded graduations for approximate volume measurement
- Suitable for liquid or solid usage
- Suitable for food contact applications in accordance with EU and USA regulations
- Space saving design

Product Code	Capacity (ml)	Neck I.D. (mm)	I x w x h (mm)	Pack qty.
BGE212P	25	18	32 x 32 x 51	10
BGE218P	50	24	36 x 36 x 68	10
BGE224P	100	34	48 x 45 x 88	10
BGE230P	250	34	60 x 56 x 108	10
BGE336P	500	44	80 x 67 x 135	10
BGE340P	1000	58	101 x 82 x 170	5
BGE342P	2000	58	130 x 98 x 215	5



For information on food safety, please refer to the technical section.



## Bottles, square, wide neck, wadded, HDPE



- Heavy duty wide neck bottles
- Black polypropylene lid with LDPE foam wad
- Practical square design for economic use of space
- Designed for chemical, powder or granule storage

Product Code	Capacity (ml)	Base x height (mm)	Neck I.D. (mm)	Pack qty.
BGE424P	100	47 x 74	33	10
BGE426P	125	47 x 89	33	10
BGE430P	250	60 x 106	43	10
BGE436P	500	72 x 127	52	10
BGE439P	1000	95 x 171	58	5
BGE441P	1500	101 x 184	58	5



## Bottles, round, wide neck, PTFE



- Opaque PTFE bottles
- Rigid with a smooth surface
- Resist all chemicals except molten alkali metals and fluorine
- Suitable for food contact applications in accordance with USA regulations
- Slope shoulder for easy pouring of powders or liquids
- Manufactured from USP Class VI grade PTFE
- Can withstand temperatures up to 260°C

Product Code	Capacity (ml)	Diam. x height (mm)	Neck I.D. (mm)	Pack qty.
BWN118	50	43 x 76	25	1
BWN124	100	52 x 88	35	1
BWN130	250	67 x 115	42	1



For information on food safety, please refer to the technical section.



Do not use when sealed for chemical reactions or digestions. Loosen lids when thermally sterilising.

# New Improved Azlon Storage Bottles

Leak-proof, liner-less design



Secure closure comes from high quality moulded threads and seal profiles on bottle and cap.

A pronounced collar provides an effective anchor for shrink wrap.

The smooth inner neck and base contours provide easy pouring and effective access for cleaning.

Base mouldings include recycling codes, bottle volumes and registration ramp as standard across the range.

The new improved Azlon Storage bottles are suitable for a wide range of applications including sample collection, mixing, preparation, transporting and storage.

They are manufactured to a new leak-proof, liner-less design. Precision injection blow moulding provides effective sealing between bottle and cap without the need for loose cap insert liners.

The range has good chemical resistance and is available in polyethylene, polypropylene and amber polypropylene for the storage of light sensitive samples.

Polypropylene bottles are suitable for autoclaving at 121°C.





# Technical information - wash bottles

Azlon Multi-lingual wash bottles are available in a number of language combinations and possess information on solvent identity and Globally Harmonised System hazard and safety information. The Azlon Multi-lingual OSHA (Occupational Safety and Health Administration) range also displays pictograms indicating appropriate Personal Protective Equipment (PPE) for use. Azlon wash bottles are available in a variety of designs and sizes for general and specific applications either non-vented or vented to prevent solvent loss.

## Wash bottle dimensions

Wide Neck Wash Bottles					
Capacity (ml)	Height (mm)	Bottle OD (mm)	Neck ID (mm)	Neck OD (mm)	Cap ID (mm)
250	140	60	34	38	46
500	163	75	34	38	46
1000	202	90	34	38	46
Narrow Neck Wash Bottles					
Capacity (ml)	Height (mm)	Bottle OD (mm)	Neck ID (mm)	Neck OD (mm)	Cap ID (mm)
250	139	59	21	25	28
500	160	73	21	25	28
Slope Shoulder Wash Bottles					
Capacity (ml)	Height (mm)	Bottle OD (mm)	Neck ID (mm)	Neck OD (mm)	Cap ID (mm)
250	152	54	21	25	28
500	187	69	21	25	28
1000	246	84	21	25	28

## Region Key for multi-lingual wash bottles

Languages	
● <b>Region 1</b>	English, French, German & Spanish
● <b>Region 2</b>	Norwegian, Danish, Swedish & English
● <b>Region 3</b>	Russian, Polish, German & English
● <b>Region 4</b>	Arabic, French & English

Please use this key when selecting the language you require

USA, National Fire Protection Association (NFPA) Diamond codes. For emergency response, chemicals are ranked according to the hazard they present. Rating 4 represents the greatest hazard and 0 the lowest.

### Top Diamond

Fire Hazard - Flash Point  
 4 - Below 70°F/21°C  
 3 - Below 100°F/38°C  
 2 - Below 200°F/93°C  
 1 - Above 200°F/93°C  
 0 - Non-flammable

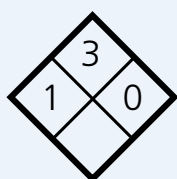

### Bottom Diamond

Special Hazard - Warning pictograms, including those for chemicals that are:  
 Air-reactive  
 Water-reactive  
 Carcinogenic

### Left-hand Diamond

Health Hazard  
 4 - Deadly  
 3 - Extremely dangerous  
 2 - Hazardous  
 1 - Slightly hazardous  
 0 - Normal material

### Right-hand Diamond

Reactivity Hazard  
 4 - Explosive  
 3 - Shock and heat may detonate  
 2 - Violent change may occur  
 1 - Unstable if heated  
 0 - Normally stable

## GHS Pictograms



Flammable Hazard

Corrosive

Toxic

Health Hazard



Harmful/Irritant

Dangerous for the Environment

Oxidising

Wide mouth for easy filling and colour coded cap for easy recognition of solvent.

Chemical name.

Chemical formulae and CAS number for easy identification of solvent contained.

Globally Harmonised System pictograms.

Signal word (i.e. 'Danger') – to identify the severity of the hazard statements.



Available with patented Driplok technology which prevents solvent loss by allowing vapour to vent.

Safety information in up to four languages.

See page 75 for Multi-lingual wash bottles with additional Occupational Safety and Health Administration (OSHA) Personal Protective Equipment (PPE) pictograms

## Bottles, wash, multi-lingual, safety venting, wide neck, LDPE



- Multi-lingual wide neck wash bottles featuring the patented DripLok® vapour venting valve that prevents solvent drips
- Indelibly printed in up to four languages (Please refer to the Region Key for a list of the languages that are printed on each wash bottle)
- Choose from five solvent labels all including the new Globally Harmonised Symbols, NFPA diamond, risk phrases and safety information
- Fitted with colour coded one-piece PP closures that maintain their shape in use
- Closures feature precision jet-tip aperture for fine control



Product Code	Capacity (ml)	Print label	Closure colour	Country Region	Pack qty.	
WGW531VTML	250	Acetone	Red	Region 1	5	
WGW535VTML	250	Ethanol	Orange	Region 1	5	
WGW534VTML	250	I.M.S	Yellow	Region 1	5	
WGW533VTML	250	Isopropanol	Blue	Region 1	5	
WGW532VTML	250	Methanol	Green	Region 1	5	
WGW537VTML	500	Acetone	Red	Region 1	5	
WGW541VTML	500	Ethanol	Orange	Region 1	5	
WGW540VTML	500	I.M.S	Yellow	Region 1	5	
WGW539VTML	500	Isopropanol	Blue	Region 1	5	
WGW538VTML	500	Methanol	Green	Region 1	5	
WGW550VTML	500	I.D.A	Yellow	Region 1	5	
WGW537VTMLS	500	Acetone	Red	Region 2	5	<b>NEW</b>
WGW541VTMLS	500	Ethanol	Orange	Region 2	5	<b>NEW</b>
WGW539VTMLS	500	Isopropanol	Blue	Region 2	5	<b>NEW</b>
WGW538VTMLS	500	Methanol	Green	Region 2	5	<b>NEW</b>
WGW537VTMLR	500	Acetone	Red	Region 3	5	<b>NEW</b>
WGW541VTMLR	500	Ethanol	Orange	Region 3	5	<b>NEW</b>
WGW539VTMLR	500	Isopropanol	Blue	Region 3	5	<b>NEW</b>
WGW538VTMLR	500	Methanol	Green	Region 3	5	<b>NEW</b>
WGW537VTMLME	500	Acetone	Red	Region 4	5	<b>NEW</b>
WGW541VTMLME	500	Ethanol	Orange	Region 4	5	<b>NEW</b>
WGW539VTMLME	500	Isopropanol	Blue	Region 4	5	<b>NEW</b>
WGW538VTMLME	500	Methanol	Green	Region 4	5	<b>NEW</b>

Region Key for multi-lingual wash bottles	
Languages	
● <b>Region 1</b>	English, French, German & Spanish
● <b>Region 2</b>	Norwegian, Danish, Swedish & English
● <b>Region 3</b>	Russian, Polish, German & English
● <b>Region 4</b>	Arabic, French & English

Please use this key when selecting the language you require



## Bottles, wash, multi-lingual, non-venting, wide neck, LDPE



- Multi-lingual wide neck wash bottles
- Indelibly printed in up to four languages (Please refer to the Region Key for a list of the languages that are printed on each wash bottle)
- Choose from up to three water or five solvent labels all including the new Globally Harmonised Symbols, NFPA diamond, risk phrases and safety information
- Fitted with colour coded one-piece PP closures that maintain their shape in use
- Closures feature precision jet-tip aperture for fine control

Product Code	Capacity (ml)	Print label	Closure colour	Country Region	Pack qty.	
WGW600PML	250	Distilled water	White	Region 1	5	
WGW602PML	250	Deionised water	White	Region 1	5	
WGW530PML	250	Water	White	Region 1	5	
WGW531PML	250	Acetone	Red	Region 1	5	
WGW532PML	250	Methanol	Green	Region 1	5	
WGW533PML	250	Isopropanol	Blue	Region 1	5	
WGW534PML	250	I.M.S	Yellow	Region 1	5	
WGW535PML	250	Ethanol	Orange	Region 1	5	
WGW536PML	500	Water	White	Region 1	5	
WGW601PML	500	Distilled water	White	Region 1	5	
WGW603PML	500	Deionised water	White	Region 1	5	
WGW537PML	500	Acetone	Red	Region 1	5	
WGW538PML	500	Methanol	Green	Region 1	5	
WGW539PML	500	Isopropanol	Blue	Region 1	5	
WGW540PML	500	I.M.S	Yellow	Region 1	5	
WGW541PML	500	Ethanol	Orange	Region 1	5	
WGW601PMLS	500	Distilled water	White	Region 2	5	<b>NEW</b>
WGW603PMLS	500	Deionised water	White	Region 2	5	<b>NEW</b>
WGW536PMLS	500	Water	White	Region 2	5	<b>NEW</b>
WGW601PMLR	500	Distilled water	White	Region 3	5	<b>NEW</b>
WGW601PMLME	500	Distilled water	White	Region 4	5	<b>NEW</b>

### Region Key for multi-lingual wash bottles

#### Languages

- **Region 1** English, French, German & Spanish
- **Region 2** Norwegian, Danish, Swedish & English
- **Region 3** Russian, Polish, German & English
- **Region 4** Arabic, French & English

Please use this key when selecting the language you require

## Bottles, wash, multi-lingual, OSHA, wide neck. LDPE



- Multi-lingual wide neck, OSHA, wash bottles featuring the patented DripLok® vapour venting valve that prevents solvent drips
- Indelibly printed in 3 languages (English, French and Spanish)
- Choose from five solvent labels all including the GHS, NFPA diamond, PPE pictograms, risk and safety information
- Fitted with colour coded one-piece PP closures that maintain their shape in use
- Closures feature precision jet-tip aperture for fine control

Product Code	Capacity (ml)	Cap Type	Print label	Closure colour	Pack qty.
WGW537VTMLA	500	Vapour-venting	Acetone	Red	5
WGW541VTMLA	500	Vapour-venting	Ethanol	Orange	5
WGW539VTMLA	500	Vapour-venting	Isopropanol	Yellow	5
WGW538VTMLA	500	Vapour-venting	Methanol	Green	5
WGW601PMLA	500	Non-venting	Distilled water	White	5



New

## Bottles, wash, DIY, wide neck, LDPE



- Do-it-yourself DripLok® wash bottles with blank write-on-panel
- Indelibly printed in 3 languages (English, French and German)
- Supplied with adhesive hazard labels

Product Code	Description	Cap Type	Pack qty.
WGW001VTML	250ml Custom/DIY with white cap	Vapour-venting	5
WGW002VTML	500ml Custom/DIY with white cap	Vapour-venting	5
WGW020VTML	1000ml Custom/DIY with white cap	Vapour-venting	5
WGW004VTML	500ml Custom/DIY with mixed colour caps	Vapour-venting	5
WGW001PML	250ml Custom/DIY with white cap	Non-venting	5
WGW002PML	500ml Custom/DIY with white cap	Non-venting	5
WGW020PML	1000ml Custom/DIY with white cap	Non-venting	5
WGWPEN01	Indelible black marker pen for custom/DIY wash bottles		2



New



## Bottles, wash, Gram stain, venting, LDPE



- Pre-labelled with Gram stain solutions, hazard warning labels and instructions for use
- With patented DripLok® vapour venting technology
- The set of five wash bottles are printed with:-
  - Crystal violet solution
  - Lugol's iodine solution
  - Gram iodine solution
  - Gram colour/de-colourising solution
  - Safranin solution

Product Code	Description	Pack qty.
WGW0255V	Set of five 250ml Gram Stain venting wash bottles	5



## Bottles, wash, tracker, LDPE



- Wash bottle designed with complete labelling facility to ensure full traceability
- Meets industry standards including those required by the Clinical Pathology Accreditation body
- Ideal for use in the clinical & general hospital market
- Unique write-on, wipe-off panel
- DripLok® vapour venting cap version available - for ultimate safety with volatile solvents
- Supplied with a set of COSHH labels

Product Code	Capacity (ml)	Cap Type	Closure colour	Pack qty.
WTR250P	250	Non-venting	Green	5
WTR250VT	250	Vapour-Venting	Red	5
WTR500P	500	Non-venting	Green	5
WTR500VT	500	Vapour-Venting	Red	5

 Recordable information includes: bottle contents, first use and expiry dates, lot number, COSHH information, originator and date of receipt/preparation.

**Bottles, wash, safety venting, wide neck, LDPE**  *Azlon*

- Square shoulder wash bottles featuring a wide neck for easy spill-free filling and the patented DripLok® vapour venting valve that prevents solvent drips
- Fitted with colour-coded one-piece PP closures that maintain their shape in use
- Closures feature precision jet-tip aperture for fine control

Product Code	Capacity (ml)	Closure colour	Pack qty.
WGW236PVENT	500	White	5
WGW237PVENT	500	Red	5
WGW238PVENT	500	Yellow	5
WGW239PVENT	500	Green	5
WGW235PVENT	500	Blue	5
WGW234PVENT	500	Orange	5
WGW443VT	1000	White	5
WGW444VT	1000	Red	5
WGW445VT	1000	Yellow	5
WGW446VT	1000	Green	5
WGW447VT	1000	Blue	5
WGW448VT	1000	Orange	5



**Bottles, wash, non-venting, wide neck, LDPE**  *Azlon*

- Square shoulder wash bottles featuring a wide neck for easy spill-free filling
- Fitted with colour-coded one-piece PP closures that maintain their shape in use
- Closures feature precision jet-tip aperture for fine control

Product Code	Capacity (ml)	Closure colour	Pack qty.
WGW230P	250	White	5
WGW231P	250	Red	5
WGW232P	250	Yellow	5
WGW233P	250	Green	5
WGW234P	250	Blue	5
WGW236P	500	White	5
WGW237P	500	Red	5
WGW238P	500	Yellow	5
WGW239P	500	Green	5
WGW235P	500	Blue	5
WGW443P	1000	White	5
WGW445P	1000	Red	5
WGW444P	1000	Yellow	5
WGW447P	1000	Green	5
WGW446P	1000	Blue	5
WGW229P	250	Mixed pack one of each colour	1



New



## Screwcaps for wide neck wash bottles, safety venting



- Caps for wide neck wash bottles with dip-tube and patented Driplok® vapour venting valve that prevents solvent drips
- Available in six colours
- One-piece PP closures that maintain their shape in use
- Closures feature precision jet-tip aperture for fine control

Product Code	Closure colour	Pack qty.
WBCAPVW	White	5
WBCAPVR	Red	5
WBCAPVY	Yellow	5
WBCAPVG	Green	5
WBCAPVB	Blue	5
WBCAPVOR	Orange	5



## Bottles, wash, classic style, narrow neck, LDPE



- Traditional and popular square shoulder round wash bottles
- Fitted with one-piece PP closures that maintain their shape in use
- Closures feature precision jet-tip aperture for fine control

Product Code	Capacity (ml)	Closure colour	Pack qty.
WGF230P	250	White	5
WGF236P	500	White	5

### Bottles, wash, coloured, narrow neck, LDPE



- Coloured wash bottles with matching closures
- Ideal for colour-coding purposes
- Fitted with polypropylene closures
- Choice of four colours

Product Code	Capacity (ml)	Bottle colour	Pack qty.
WGR036P	500	Green	5
WGR038P	500	Red	5
WGR136P	500	Yellow	5
WGR138P	500	Blue	5



### Bottles, wash, slope shoulder, narrow neck, LDPE



- The slim design enables comfortable handling and enhanced ease of use
- Fitted with a choice of white or red polypropylene swivel dispensing closures
- Choice of three sizes
- Closures feature precision jet-tip aperture for fine control

Product Code	Capacity (ml)	Closure colour	Pack qty.
WGF330P	250	White	5
WGF331P	250	Red	5
WGF336P	500	White	5
WGF337P	500	Red	5
WGF240P	1000	White	5
WGF241P	1000	Red	5





# Bottles



## Bottles, wash, slope shoulder, printed, LDPE



- Labelled wash bottles for easy identification of contents
- Indelibly printed with a choice of seven popular laboratory solvents, appropriate hazard symbols and CAS numbers
- The slim design enables comfortable handling and enhanced ease of use
- Fitted with colour-coded polypropylene closures
- Closures feature precision jet-tip aperture for fine control

Product Code	Capacity (ml)	Printed	Print / closure colour	Pack qty.
WGF530P	250	Water	White	5
WGF600P	250	Distilled water	White	5
WGF531P	250	Acetone	Red	5
WGF532P	250	Methanol	Green	5
WGF533P	250	Isopropanol	Blue	5
WGF534P	250	I.M.S.	Yellow	5
WGF535P	250	Ethanol	Orange	5
WGF536P	500	Water	White	5
WGF601P	500	Distilled water	White	5
WGF537P	500	Acetone	Red	5
WGF538P	500	Methanol	Green	5
WGF539P	500	Isopropanol	Blue	5
WGF540P	500	I.M.S.	Yellow	5
WGF541P	500	Ethanol	Orange	5



## Bottles, wash, integral, narrow neck, LDPE



- Ergonomic wash bottles with an integrally moulded dispensing tube jet tip
- Slim hexagonal cross section makes the bottles particularly suited to smaller hands
- Precision tip is ideal for fine liquid jet dispensing

Product Code	Capacity (ml)	Bottle colour	Pack qty.
BGF130P	250	Natural	5
BGF136P	500	Natural	5

**Bottles, wash, autoclavable, non-venting, wide neck, PP** 

- Autoclavable at 121°C
- PP bottle fitted with one-piece PP closure
- Closures feature precision jet-tip aperture for fine control

Product Code	Capacity (ml)	Print label	Closure colour	Pack qty.
WGW700PP	500	Autoclavable	White	5

 **Caution.** When autoclaving bottles always ensure the caps are completely loosened or removed to prevent accidental implosion. Do not autoclave if containing solvents or hazardous/reactive solutions or substances.



**Bottles, wash, multi-lingual, non-venting, wide neck, PP** 

- Multi-lingual wide neck wash bottles
- Indelibly printed in 4 languages (English, French, German and Spanish)
- Solvent labels including the new Globally Harmonised Symbols, NFPA diamond, risk phrases and safety information
- Fitted with colour coded one-piece PP closures that maintain their shape in use
- Closures feature precision jet-tip aperture for fine control

Product Code	Capacity (ml)	Print label	Closure colour	Pack qty.
WGW701PP	500	Dichloromethane	White	5
WGW703PP	500	Methyl ethyl ketone	Green	5

 **Caution.** Do not autoclave.



# Attention Attention Achtung Atención



The Azlon® multi-lingual wash bottle is now available in three new ranges that give you chemical names and safety instructions in a wider range of languages including:

- Norwegian, Swedish and Danish
- Russian and Polish
- Arabic and French

The Azlon designs reflect the Global Harmonised System (GHS) of labelling legislation including new hazard warning pictograms.

Plus, of course, you get all of the regular features and benefits of this highly popular laboratory essential, including Driplok® vapour venting technology.

Our unique two-way valve lets the vapour escape when pressure builds up and stops air getting into the liquid.

The result - no more hazardous drips or dribbles and an accurate, continuous dispensing stream.

To find out more about the Azlon multi-lingual wash bottle visit [www.scilabware.com](http://www.scilabware.com)

## Bottle carriers, cluster design, polypropylene



- A simple and safe carrying system for use in the laboratory
- Strong lightweight construction
- Will accept most 500ml bottles
- Internal cavity diameter 90mm and cavity height 135mm

Product Code	Description	l x w x h (mm)	Pack qty.
BGS024	6 compartment bottle carrier	315 x 215 x 280	1



## Bottle carriers, coated steel



- Manufactured from polyamide coated steel
- Offers better heat and chemical resistance than other coatings
- Ideal for safely carrying up to six bottles or wash bottles

Product Code	Max. bottle diam. (mm)	Pack qty.
BGS040	60	1
BGS042	74	1



# Boxes, Bubblers

## Boxes, airtight, polyethylene



- Made from tough HDPE
- Suitable for food contact applications in accordance with EU regulations
- Lightweight and unbreakable in normal use
- Tight fitting snap on lids create an airtight seal
- Suitable for general and refrigerated storage down to -50°C

Product Code	Capacity (ml)	External dim. (l x w x h) (mm)	Pack qty.
BWY030	500	100 x 100 x 65	1
BWY032	1000	100 x 100 x 125	1
BWY034	1000	210 x 100 x 65	1
BWY036	1500	210 x 100 x 90	1
BWY038	2000	210 x 210 x 65	1
BWY039	3500	210 x 210 x 90	1

## Reaction vessel bubbler



- Ideal for closing reaction mixture from the atmosphere
- Side arm to facilitate filling with mineral oil
- Bubblers have capacity of approx 5ml

Product Code	Cone size	Pack qty.
GB1/19	19/26	1
GB1/24	24/29	1
GB1/29	29/32	1

 Capacity measurement to graduated fill line.



## Reaction Vessel bubbler, with gas inlet



- Ideal for closing reaction mixture from the atmosphere
- With gas inlet to provide continuous flow of inert gas (N<sub>2</sub> or Ar) over the reaction
- Complete with detachable plastic hose connection to allow easy and safe attachment to 9mm flexible tubing
- Bubblers have capacity of approx 5ml

Product Code	Cone size	Pack qty.
GB2/19SC	19/26	1
GB2/24SC	24/29	1
GB2/29SC	29/32	1

 Capacity measurement to graduated fill line.



## Mini gas bubbler

PYREX<sup>®</sup>

- For use in inert atmosphere experiments
- Ideal for bubble counting
- Complete with detachable plastic hose connections to allow easy and safe attachment to 9mm bore flexible tubing

Product Code	Capacity (ml)	Pack qty.
GB3/SC	2	1





## Buckets, spouted, HDPE



- Durable spouted buckets for easy pouring
- Handle grip for easy lifting and carrying
- Choice of white or black
- White buckets BXW112 and BXW114 are suitable for food contact applications in accordance with EU regulations
- Moulded graduations

Product Code	Capacity (litres)	Sub div. (litres)	Diam. x height (mm)	Colour	Pack qty.
BWX104	10.5	0.5	286 x 283	Black	1
BWX106	17	0.5	330 x 315	Black	1
BWX112	10.5	0.5	286 x 283	White	1
BWX114	17	0.5	330 x 315	White	1



## Buckets, square, HDPE



- Durable square shape allows economical use of space
- Handle grip for easy lifting and carrying
- Choice of white or black
- White bucket BXW116 is suitable for food contact applications in accordance with EU regulations
- Moulded graduations (14 litre x 0.5 divisions)

Product Code	Capacity (litres)	Sub div. (litres)	External dim. (l x w x h) (mm)	Colour	Pack qty.
BWX108	14	0.5	292 x 292 x 292	Black	1
BWX116	14	0.5	292 x 292 x 292	White	1

## Buckets, square, lids, HDPE

- Lids with moulded inset handle for buckets above
- White bucket lid BXW118 is suitable for food contact applications in accordance with EU regulations

Product Code	Description	External dim. (l x w x h) (mm)	Colour	Pack qty.
BWX110	Lid for bucket	280 x 280 x 45	Black	1
BWX118	Lid for bucket	280 x 280 x 45	White	1

## Burettes, PTFE key, class AS, works certified

PYREX®

- Complies with ISO 385
- Individually tested and supplied with certificate showing exact volume dispensed at 3 points on the scale
- Individual serial number and certificate provides complete traceability to National Standards
- Each burette has a +30s waiting time before final reading can be taken
- Manufactured from precision-bore borosilicate glass tubing for high accuracy
- 1.5mm bore PTFE key which requires no lubrication
- White enamel graduations

Product Code	Capacity (ml)	Grads. (ml)	Tol. (+/- ml)	Length (mm)	Pack qty.
3295/22ASWC	10	0.02	0.02	820	1
3295/24ASWC	25	0.10	0.05	620	1
3295/26ASWC	50	0.10	0.05	820	1
3295/28ASWC	100	0.20	0.10	870	1

 3295/22ASWC is fitted with a fluted funnel top.



## Burettes, PTFE key, class AS

PYREX®

- Complies with ISO 385
- Manufactured from precision-bore tubing (borosilicate glass) for high accuracy
- Each burette has a +30s waiting time before final reading can be taken
- Graduations in white enamel for increased visibility with dark solutions
- Grease-free interchangeable PTFE key with 1.5mm bore

Product Code	Capacity (ml)	Grads. (ml)	Tol. (+/- ml)	Length (mm)	Pack qty.
3295/12AS	10	0.02	0.02	820	1
3295/14AS	25	0.10	0.05	620	1
3295/16AS	50	0.10	0.05	820	1
3295/18AS	100	0.20	0.10	870	1

 3295/12AS is fitted with fluted funnel top.





# Burettes

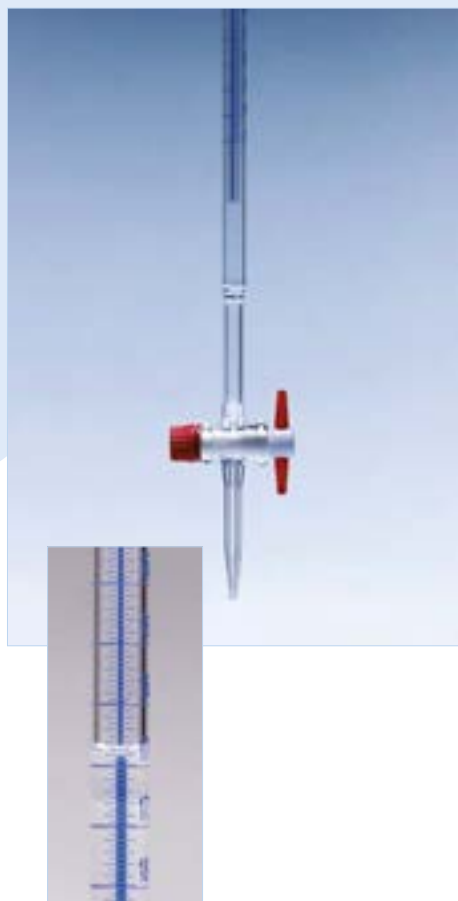

## Burettes, PTFE key, class AS, Schellbach

**PYREX®**

- Complies with ISO 385
- Graduations and inscriptions in blue enamel
- Schellbach burette tube with vertical white stripe and central blue ribbon
  - Facilitates accurate reading of meniscus
  - exact position of the meniscus is clearly defined where the blue ribbon splits into a wide and narrow band
- With funnel top to make filling easier and safer
- Each burette has a +30s waiting time before final reading can be taken
- Manufactured from chemically resistance borosilicate glass
- Grease-free interchangeable PTFE key with 1.5mm bore

Product Code	Capacity (ml)	Grads. (ml)	Tol. (+/- ml)	Length (mm)	Pack qty.
492092	10	0.05	0.03	620	1
492093	25	0.10	0.05	620	1
492094	25	0.05	0.03	820	1
492095	50	0.10	0.05	820	1



Each burette is fitted with fluted funnel top.



## Burettes, PTFE key, class B

**PYREX®**

- Complies with ISO 385
- Fitted with interchangeable PTFE keys for grease-free performance, with 1.5mm bore
- White enamel graduations for good visibility with dark coloured solutions
- Manufactured from borosilicate glass for increased chemical resistance

Product Code	Capacity (ml)	Grads. (ml)	Tol. (+/- ml)	Length (mm)	Pack qty.
3295/02	10	0.02	0.05	820	1
3295/04	25	0.10	0.10	820	1
3295/06	50	0.10	0.10	820	1
3295/08	100	0.20	0.20	870	1



3295/02 is fitted with fluted funnel top. Schools and colleges may wish to consider Azlon® tough acrylic burettes as detailed on page 94.

## Burettes, PTFE key, blue graduations, class B

**MBL®**

- Complies with ISO 385
- 10, 25 and 50 ml sizes are available fitted with funnel top to make filling easier and safer
- Grease-free PTFE stopcock with 1.5mm bore
- Graduations in easy to read blue enamel
- Manufactured from borosilicate glass

Product Code	Capacity (ml)	Grads. (ml)	Tol. (+/- ml)	Length (mm)	Pack qty.
BRB070P	10	0.02	0.05	820	1
BRB074P	25	0.10	0.10	620	1
BRB075P	25	0.10	0.10	620	1
BRB076P	50	0.10	0.10	820	1
BRB077P	50	0.10	0.10	820	1

 BRB070P, BRB075P, BRB077P are fitted with fluted funnel tops.



## Burettes, Rotaflo, PTFE key, class B

**MBL®**

- Complies with ISO 385
- With GP Rotaflo® stopcock having PTFE key
  - No lubrication required
  - No seizure with caustic solutions
  - Provides fine drop control
  - 3.0mm key bore
- Graduations in permanent amber stain which is fused into the glass and is especially resistant to aggressive cleaning solutions
- Manufactured from borosilicate glass

Product Code	Capacity (ml)	Grads. (ml)	Tol. (+/- ml)	Length (mm)	Pack qty.
BRB402	10	0.10	0.05	462	1
BRB404	25	0.10	0.10	647	1
BRB406	50	0.10	0.10	857	1
BRB408	100	0.20	0.20	897	1

 BRB402 is supplementary to ISO 385



# Burettes



**i** BRB264P and BRB266P are fitted with fluted funnel tops. BRB284 - Replacement glass jets are made from soda-lime glass.



## Burettes, modular, PTFE stopcock, class B

**MBL<sup>®</sup>**

- Complies with ISO 385
- With funnel top to make filling easier and safer
- PTFE stopcock for grease-free performance
- Easy to read blue enamel graduations
- Burette manufactured from borosilicate glass
- Modular design with detachable burette tube, stopcock and jet for easy replacement

Product Code	Capacity (ml)	Grads. (ml)	Tol. (+/- ml)	Length (mm)	Pack qty.
BRB264P	25	0.10	0.10	620	1
BRB266P	50	0.10	0.10	820	1

## Replacement parts for modular burette

Product Code	Description	Pack qty.
BRB274P	25ml glass burette tube	1
BRB276P	50ml glass burette tube	1
BRB284	Glass jet for 25 & 50ml burettes	5
SWN160	Glass jet for 25 & 50ml burettes with PTFE stopcock	10
BRB290	PTFE stopcock	10

## Burettes, glass key, class AS, Schellbach

**PYREX<sup>®</sup>**

- Complies with ISO 385
- Graduations and inscriptions in blue enamel
- Schellbach burette tube with vertical white stripe and central blue ribbon
  - Facilitates accurate reading of meniscus
  - exact position of the meniscus is clearly defined where the blue ribbon splits into a wide and narrow band
- With funnel top to make filling easier and safer
- Each burette has a +30s waiting time before final reading can be taken
- Manufactured from chemically resistance borosilicate glass
- With interchangeable 2.0mm bore glass key

Product Code	Capacity (ml)	Grads. (ml)	Tol. (+/- ml)	Length (mm)	Pack qty.
492145	10	0.05	0.03	620	1
492146	25	0.1	0.05	620	1
492147	25	0.05	0.03	820	1
492148	50	0.1	0.05	820	1

**i** Each burette is fitted with fluted funnel tops.

## Burettes, glass key, class B

**MBL®**

- Complies with ISO 385
- 2.0mm Key bore
- Replacement keys are available in the event of loss or damage: keys are fully interchangeable.
- Graduations in easy to read blue enamel
- Manufactured from borosilicate glass

Product Code	Capacity (ml)	Grads. (ml)	Tol. (+/- ml)	Length (mm)	Pack qty.
BRB050P	10	0.02	0.05	820	1
BRB056P	25	0.10	0.10	620	1
BRB058P	50	0.10	0.10	820	1
BRB060P	100	0.20	0.20	870	1

 BRB050P has a fluted funnel top. SSD102K Spare keys are available on page 252



## Burettes, Sofnol, auto zero, Rotaflo stopcock, class B **PYREX®**

- Complies with ISO 385
- Easy filling and automatic zero
  - Squeeze the polyethylene bottle to fill the burette
  - Release pressure to allow excess liquid to drain back into bottle and set the burette to zero
- With PTFE Rotaflo® Stopcock for grease-free performance and fine drop-wise control
- 3mm bore PTFE key
- Graduations in white enamel
- Manufactured from borosilicate glass
- Burettes and bottles should be ordered separately

Product Code	Capacity (ml)	Grads. (ml)	Tol. (+/- ml)	Pack qty.
3298/02	10	0.1	0.10	5
3298/03	20	0.1	0.10	5
3298/04	25	0.1	0.10	5



## Polyethylene reservoir bottles

Product Code	Description	Pack qty.
3299/04	500ml Polyethylene reservoir bottle	1
3299/06	1000ml Polyethylene reservoir bottle	1

# Burettes



## Burettes, Sofnol, auto zero, pinch valve, class B

**MBL®**

- Complies with ISO 385
- Easy filling and automatic zero
  - Squeeze the polyethylene bottle to fill burette
  - Release pressure to allow excess liquid to drain back into bottle and set the burette to zero
- Easy to read blue enamel graduations
- Manufactured from borosilicate glass
- With simple rubber tube and pinch valve for low cost replacement

Product Code	Capacity (ml)	Grads. (ml)	Tol. (+/- ml)	Reservoir bottle capacity (ml)	Pack qty.
BRB004	10	0.1	0.10	500	1
BRB006	20	0.1	0.10	1000	1

## Replacement parts

Product Code	Description	Pack qty.
3299/04	500ml Polyethylene reservoir bottle	1
3299/06	1000ml Polyethylene reservoir bottle	1
BRB042	Rubber pinch valve and glass jet	5
BRB256	Glass jet only	5



## Burettes, automatic, PTFE key, class AS

**PYREX®**

- Complies with ISO 385 and DIN 12700
- With automatic zero facility
- Simple operation
  - To fill burette apply a slight positive pressure to lower side-arm
  - To set zero, release pressure to allow excess liquid to siphon back into the bottle
- Burettes manufactured from chemically resistant Pyrex® borosilicate glass
- White enamel graduations
- 1.5mm bore PTFE key stopcock
- Burettes and accessories should be ordered separately

Product Code	Capacity (ml)	Grads. (ml)	Tol. (+/- ml)	Pack qty.
3296/02AS	10	0.02	0.02	1
3296/04AS	25	0.05	0.03	1
3296/06AS	50	0.10	0.05	1



All Automatic burettes feature a 29/32 cone.

## Burettes, automatic, PTFE key, class AS, Schellbach PYREX®

- Complies with ISO 385 and DIN 12700
- With automatic zero facility
- Burettes manufactured from chemically resistant Pyrex® borosilicate glass and feature a 29/32 Quickfit® cone
- Blue enamel graduations with Schellbach stripe
- Schellbach burette tube with vertical white stripe and central blue ribbon
  - facilitates accurate reading of the meniscus
  - exact position of the meniscus is clearly defined where the blue ribbon splits into a wide and narrow band
- 1.5mm bore PTFE key stopcock

Product Code	Capacity (ml)	Grads. (ml)	Tol. (+/- ml)	Pack qty.
3396/02AS	10	0.02	0.02	1
3396/04AS	25	0.05	0.03	1
3396/06AS	50	0.10	0.05	1

 Burettes and accessories should be ordered separately.



## Burettes, automatic, PTFE key, class AS, Schellbach, PYREX® with intermediate stopcock

- Complies with ISO 385 and DIN 12700
- With automatic zero facility
- Intermediate stopcock facilitates easy drainage of liquid back into reservoir
- Burettes manufactured from chemically resistant Pyrex® borosilicate glass and feature a 29/32 Quickfit® cone
- Blue enamel graduations with Schellbach stripe
- Schellbach burette tube with vertical white stripe and central blue ribbon
  - facilitates accurate reading of the meniscus
  - exact position of the meniscus is clearly defined where the blue ribbon splits into a wide and narrow band
- 1.5mm bore PTFE key stopcock

Product Code	Capacity (ml)	Grads. (ml)	Tol. (+/- ml)	Pack qty.
3496/02AS	10	0.02	0.02	1
3496/04AS	25	0.05	0.03	1
3496/06AS	50	0.10	0.05	1

 All automatic burettes feature a 29/32 Quickfit® cone.



# Burettes



## Automatic burette accessories

Product Code	Description	Pack qty.
3297/12	2000ml glass reservoir with 29/32 joint	1
3297/14AS	Rubber blowing ball to fit Class AS Auto burettes	1

**i** 2L reservoir is manufactured from soda-lime glass.



## Burettes, acrylic, with PMP/PE stopcocks, class B



- Acrylic construction for strength and transparency
- Graduations are screen printed in black to ISO 385 Class B accuracy
- Suitable for use in educational laboratories especially where breakages often occur
- Unaffected by most dilute aqueous solutions, however unsuitable for use with organic solvents
- Turning the stopcock through 90° makes it suitable for left or right handed use
- Stopcocks can be removed for easy cleaning

Product Code	Capacity (ml)	Grads. (ml)	Tol. (+/- ml)	Pack qty.
BDH112T	25	0.1	0.1	1
BDH118T	50	0.1	0.1	1
BDH124T	100	0.2	0.2	1

## Burettes, acrylic, spares

Product Code	Description	Pack qty.
SWQ030TAR	Spare stopcock for BDH118T & 124T	1
SWQ028T	Spare stopcock for BDH112T	1

**i** \*See chemical resistance chart in the technical section for more details.

## Chromatography column, plain

**PYREX®**

- Simple and economical column - ideal for educational use
- With chemically resistant glass sintered disc - porosity 1
- Manufactured from Pyrex® borosilicate glass

Product Code	Nom. capacity (ml)	Body O.D. (mm)	Length excluding stem (mm)	Stem O.D. (mm)	Pack qty.
3775/02M	30	14	355	8	5



## Chromatography columns with Rotaflo stopcock



- With PTFE Rotaflo® Stopcock for fine control of eluent flow
- Chemically resistant glass sintered disc - porosity 0
- Ground glass socket accepts Quickfit® reservoirs
- Manufactured from borosilicate glass

Product Code	I.D. (mm)	Effective length (mm)	Socket size	Pack qty.
CR10/10	10	100	14/23	1
CR10/20	10	200	14/23	1
CR10/30	10	300	14/23	1
CR10/40	10	400	14/23	1
CR20/20	20	200	19/26	1
CR20/30	20	300	19/26	1
CR20/40	20	400	19/26	1
CR20/50	20	500	19/26	1
CR30/40	26	400	24/29	1
CR30/50	26	500	24/29	1
CR40/40	30	400	29/32	1
CR40/50	30	500	29/32	1
CR50/40	30	400	34/35	1
CR50/50	30	500	34/35	1
CR60/40	40	400	40/38	1
CR60/50	40	500	40/38	1





# Chromatography

## Chromatography columns, Rotaflor stopcock and ground cone



- With glass sintered disc - porosity 0 to support column packing
- GP Rotaflor® stopcock with PTFE key for fine control of eluent flow
- Stem within lower cone allows mounting on a Büchner flask for vacuum flash chromatography
- Manufactured from borosilicate glass

Product Code	I.D. (mm)	Effective length (mm)	Approx overall length (mm)	Socket size	Cone size	Pack qty.
CR12/10	10	100	270	14/23	19/26	1
CR12/30	10	300	470	14/23	19/26	1

## Chromatography columns, with ground cone



- With glass sintered disc - porosity 0 to support column packing
- Upper socket can be connected to a solvent reservoir
- Lower cone can be connected to stopcock adapter CR3T/23 to control eluent flow
- Manufactured from borosilicate glass

Product Code	I.D. (mm)	Effective length (mm)	Approx overall length (mm)	Socket size	Cone size	Pack qty.
CR32/20	18	200	310	24/29	19/26	1
CR32/30	18	300	415	24/29	19/26	1
CR32/40	18	400	515	24/29	19/26	1

## Chromatography, stopcock adapter



- With GP Rotaflor® stopcock having PTFE key for fine control of eluent flow
  - No lubrication required
  - No contaminating greases
  - No chemical corrosion
- Ideal for use with Quickfit® CR32: columns

Product Code	Socket size	Cone size	Approx overall height (mm)	Stopcock bore (mm)	Pack qty.
CR3T/23	19/26	24/29	190	6.0	1

## Clamps, burette, polypropylene & rubber



- Spring loaded polypropylene clamps that are corrosion resistant
- Allow clear view of graduations along the full length of the burette
- Rubber grips prevent slipping
- An interchangeable compression cone on the central boss provides a firm grip on rods 11 - 14mm in diameter

Product Code	Model	Pack qty.
CWH002	Single clamp	1
CWH004	Double clamp	1



## Clamps, tubing



- For use with flexible rubber and plastic tubing
- Provides fine flow control of liquids and gases
- Easy one-handed adjustment: just roll serrated wheel along sloped floor
- Manufactured from thermoplastic polyester

Product Code	For tubing size	Pack qty.
KT4.5	O.D. up to 4.5mm	5
KT6	O.D. up to 6mm	5
KT10	O.D. up to 10 mm	5
KT14	O.D. up to 14mm	5



## Concentrate, Lipsol Detergent

- Excellent cleaning performance, ideal for use with laboratory glassware, plasticware, rubber, ceramics and stainless steel
- Economical price
- Non-corrosive, non-irritant and totally biodegradable surface-active cleaning agent
- Free of chlorine bleaches, phosphates and enzymes

Product Code	Description	Pack qty.
40023	Lipso <sup>®</sup> concentrate 2 x 5 Litre Jerry Cans	1



Not suitable for use on non-ferrous metals, especially aluminium, zinc or on polycarbonates. Product information, MSDS's and batch certificates downloadable from the SciLabware website.



# Cold traps, condensers



## Cold trap



- Designed for use in vacuum systems
- Prevents vapours and volatile materials from damaging pumps etc.
- Easy to use:
  - immerse trap into Dewar vessel containing refrigerant e.g. dry ice
  - volatile materials passing through system are frozen onto the cold surface

Product Code	Description	Socket size	Cone size	Pack qty.
MF28/52	Trap head	19/26	34/35 & 19/26	1
MF24/5	Trap body, 250mm overall length	34/35	-	5



Trap head can be connected to flexible vacuum hose using adapters MF10/2B/SC and MF13/2/SC.



## Condenser, Air



- Simple condensers for condensation of materials with boiling points above 150°C

Product Code	Approx surface area (x 10 <sup>-2</sup> m <sup>2</sup> )	Socket size	Cone size	Approx effective length (mm)	Approx overall length (mm)	Pack qty.
C2/11	1.0	14/23	14/23	200	260	1
C2/12	1.0	19/26	19/26	150	210	1
FC7/23	2.0	24/29	24/29	250	365	1
C2/22	2.5	19/26	19/26	400	470	1
FC7/43	4.0	24/29	24/29	500	615	1



## Condenser, Allihn, with ground cone



- Ideal for reflux applications
- Inner bulb sections provide increased cooling surface
- With detachable plastic screwthread connectors for easy and safe attachment of flexible tubing

Product Code	Approx surface area (x 10 <sup>-2</sup> m <sup>2</sup> )	Cone size	Approx effective length (mm)	Approx overall length (mm)	Pack qty.
CX7/02/SC	1.3	19/26	250	400	1
CX7/03/SC	1.3	24/29	250	405	1
CX7/04/SC	1.3	29/32	250	415	1
CX7/05/SC	1.3	34/35	250	335	1
CX7/06/SC	1.3	40/38	250	365	1
CX7/08/SC	1.5	50/42	250	365	1

## Condenser, Allihn, with ground cone and socket



- As above but with ground socket

Product Code	Approx surface area (x 10 <sup>-2</sup> m <sup>2</sup> )	Socket size	Cone size	Approx effective length (mm)	Approx overall length (mm)	Pack qty.
CX7/33/SC	1.8	24/29	24/29	400	545	1
CX7/44/SC	1.8	29/32	29/32	400	550	1

 For spare screwthread connectors please refer to page 104.



## Condenser, coil, with ground cone



- Coolant is circulated through a coil having a very large cooling surface
- Ideal for use in the upright reflux mode where counter-current cooling is possible
- Supplied with detachable plastic connectors for the attachment of rubber hose

Product Code	Approx surface area (x 10 <sup>-2</sup> m <sup>2</sup> )	Cone size	Approx effective length (mm)	Approx overall length (mm)	Pack qty.
CX3/05/SC	2.0	34/35	160	320	1
CX3/06/SC	3.5	40/38	207	380	1
CX3/08/SC	2.0	50/42	155	348	1

 For spare screwthread connectors, please refer to page 104.



## Condenser, coil, with ground cone and socket



- Suitable for either reflux or distillation work
- Highly efficient condensers with a large cooling surface
- Supplied with detachable plastic screwthread connectors which allow 9mm flexible tubing to be fitted easily and safely

Product Code	Approx surface area (x 10 <sup>-2</sup> m <sup>2</sup> )	Socket size	Cone size	Approx effective length (mm)	Approx overall length (mm)	Pack qty.
C3/12/SC	2.0	19/26	19/26	165	305	1
C3/13/SC	2.0	24/29	24/29	165	310	1
C3/14/SC	2.0	29/32	29/32	165	315	1
C3/22/SC	4.0	19/26	19/26	320	460	1
C3/23/SC	4.0	24/29	24/29	320	465	1
C3/24/SC	4.0	29/32	29/32	320	470	1



# Condensers



## Condenser, coil, reversible



- Highly versatile reflux condensers
- Each end of the condenser is fitted with a different size cone thus reducing the need for adapters
- With detachable plastic connectors for the attachment of flexible tubing

Product Code	Approx surface area (x 10 <sup>-2</sup> m <sup>2</sup> )	Cone size	Approx effective length (mm)	Approx overall length (mm)	Pack qty.
CX3/23/SC	2.0	19/26 & 24/29	160	315	1
CX3/35/SC	2.0	24/29 & 34/35	160	335	1



## Condenser, twin-coil



- With two independent cooling coils
- Each can be fed from separate water supplies for maximum efficiency

Product Code	Approx surface area (x 10 <sup>-2</sup> m <sup>2</sup> )	Socket size	Cone size	Approx effective length (mm)	Approx overall length (mm)	Pack qty.
C4/13/SC	5.5	24/29	24/29	207	390	1

**i** For spare screwthread connectors, please refer to page 104.



## Condenser, multi-coil, large scale



- Features a double coil design with a common water inlet
- Suitable for pilot plant work
- Glass side arms accept tubing with an internal diameter of 18mm

Product Code	Approx surface area (x 10 <sup>-2</sup> m <sup>2</sup> )	Socket size	Cone size	Approx effective length (mm)	Approx overall length (mm)	Pack qty.
C13/55	9.0	34/35	34/35	230	440	1
C13/55/2	18.0	34/35	34/35	420	660	1

**i** Due to their larger size, these condensers have glass olives for the attachment of flexible tubing.

## Condenser, jacketed coil



- Complies with DIN 12593
- Coil condenser has an outer water jacket
- Coil provides large cooling surface
- Jacket avoids vapour creeping around the coil
- Ideal for reflux work

Product Code	Approx surface area (x 10 <sup>-2</sup> m <sup>2</sup> )	Socket size	Cone size	Approx effective length (mm)	Approx overall length (mm)	Pack qty.
CX6/22/SC	4.0	19/26	19/26	160	360	1
CX6/33/SC	4.0	24/29	24/29	160	365	1
CX6/44/SC	4.0	29/32	29/32	160	370	1
CX6/05/SC	4.0	-	34/35	160	380	1

 CX6/05/SC has one 34/35 cone and a plain glass chimney at the top.



## Condenser, cold finger



- For immersion into distillation assemblies etc.
- Can be used to regulate refluxing by adjusting the flow of air or water through it

Product Code	Approx surface area (x 10 <sup>-2</sup> m <sup>2</sup> )	Cone size	Approx effective length (mm)	Approx overall length (mm)	Pack qty.
FC14/00/SC	0.35	19/26	100	185	1



# Condensers



## Condenser, double surface, Davies



- Highly efficient condenser with large cooling surface
- Inner cooling surface gives 'baffle' effect
- Outer cooling surface prevents 'creep' with low boiling point liquids
- With detachable plastic screwthread connectors for easy and safe attachment of flexible tubing

Product Code	Approx surface area (x 10 <sup>-2</sup> m <sup>2</sup> )	Socket size	Cone size	Approx effective length (mm)	Approx overall length (mm)	Pack qty.
C5/11/SC	1.7	14/23	14/23	160	275	1
C5/12/SC	1.7	19/26	19/26	160	295	1
C5/13/SC	2.3	24/29	24/29	160	300	1
C5/22/SC	2.3	19/26	19/26	205	340	1
C5/23/SC	3.0	24/29	24/29	205	345	1
C5/24/SC	3.0	29/32	29/32	205	365	1
CX5/23/SC	3.0	-	24/29	205	350	1
CX5/25/SC	3.0	-	34/35	205	360	1

**i** CX5/23/SC and CX5/25/SC are fitted with a plain glass chimney instead of a socket.



## Condenser, ether



- Highly efficient coil condenser suitable for condensing very volatile liquids
- Inner coil with large surface area
- Outer water jacket to avoid vapour creep around the coil
- Coil and jacket are independent and can be fed from separate water supplies for maximum efficiency
- With detachable plastic screwthread connectors for the easy and safe attachment of flexible tubing

Product Code	Approx effective length (mm)	Approx overall length (mm)	Approx surface area (x 10 <sup>-2</sup> m <sup>2</sup> )	Cone size	Pack qty.
C11/23/SC	165	315	6.5	24/29	1

**i** For spare screwthread connectors, please refer to page 104.

## Condenser, Inland Revenue



- Inland Revenue Pattern
- Highly efficient
- Vapour and distillate move down through the coil
- Coolant water flows outside the coil
- Complete with detachable plastic hose connectors for the easy and safe attachment of flexible tubing

Product Code	Approx surface area (x 10 <sup>-2</sup> m <sup>2</sup> )	Socket size	Cone size	Approx effective length (mm)	Approx overall length (mm)	Pack qty.
C6/12/SC	2.5	19/26	19/26	205	340	1
C6/13/SC	2.5	24/29	24/29	205	340	1



*Inland Revenue condensers should be used in the vertical mode only with vapour fed in via the upper socket and liquid distillate leaving via the lower cone. Distillation rates should be slow to avoid 'slugging' and back pressure in the coil.*



## Condenser, Liebig, with ground cone and socket



- Complies with DIN 12576
- Popular water-jacketed condenser suitable for distillation and reflux applications
- With detachable plastic screwthread connectors for easy and safe attachment of rubber hose

Product Code	Approx surface area (x 10 <sup>-2</sup> m <sup>2</sup> )	Socket size	Cone size	Approx effective length (mm)	Approx overall length (mm)	Pack qty.
C1/00	0.15	10/19	10/19	60	135	1
C1/11/SC	0.60	14/23	14/23	160	260	1
C1/12/SC	1.00	19/26	19/26	210	340	1
C1/12/25/SC	1.30	19/26	19/26	250	380	1
C1/13/SC	1.00	24/29	24/29	250	390	1
C1/14/25/SC	1.30	29/32	29/32	250	400	1
C1/22/SC	2.00	19/26	19/26	400	530	1
C1/23/SC	2.00	24/29	24/29	400	535	1
C1/44/SC	2.90	29/32	29/32	400	550	1



*C1/00 is fitted with glass olives because of size limitations.*

## One piece distillation apparatus



- Comprises Liebig condenser, stillhead and receiver adapter in a single piece
- Angle and position pre-defined
- Simple to set up with fewer clamps required
- Less grease contamination
- No air leakage under vacuum
- No liquid hold-up at the joints

Product Code	Cone size	Socket size	Approx effective condenser length (mm)	Pack qty.
DA1/22	19/26	14/23	155	1





# Connectors



## Connectors, screwthread



- For use with glassware manufactured by SciLabware Ltd having 13mm screwthread inlets and outlets
- Allows 9mm bore rubber hose and flexible tubing to be attached to the glassware easily and safely
- Polypropylene screwthread connectors with Viton 'O' rings for use up to 140°C
- PTFE screwthread connectors with PTFE protected 'O' rings for use up to 200°C
- PTFE connectors have a high chemical resistance and are ideal for connections in contact with aggressive liquids or chemical vapours

Product Code	Description	Pack qty.
4510/02	Polypropylene screwthead connector	10
4510/04	PTFE screwthread connector	10
4511/02	Spare Viton 'O' ring	10



## Connectors, screwthread holder



- For use with all connectors manufactured by SciLabware Ltd and having 13mm screwthread inlets and outlets
- Screws onto the screwthread connector to hold it whilst inserting into the tubing
- Allows safer and easier removal of the connector from the hose or tubing
- Autoclavable

Product Code	Description	Pack qty.
4512/02	Screwthread holder	5



## Connectors, 'T' pattern, polypropylene



- "T" pattern tubing connectors in polypropylene
- Tapered arms are rigid with steps to give firm grip
- Autoclavable at 121°C with good chemical resistance

Product Code	O.D. (mm)	I.D. (mm)	Pack qty.
CWH204	4 - 7	2	10
CWH206	6 - 7	4	10
CWH208	8 - 9	7	10
CWH210	10 - 12	9	10

### Connectors, 'Y' pattern, polypropylene



- "Y" pattern tubing connectors in polypropylene
- Tapered arms are rigid with steps to give firm grip
- Autoclavable at 121°C with good chemical resistance

Product Code	O.D. (mm)	Pack qty.
CWH304	4 - 7	10
CWH306	6 - 7	10
CWH308	8 - 9	10
CWH310	10 - 12	10



### Connectors, straight pattern, polypropylene



- Straight pattern tubing connectors in white polypropylene
- For connecting tubing of similar or different sizes
- Tapered arms are rigid with steps to give firm grip
- Autoclavable at 121°C with good chemical resistance

Product Code	O.D. (mm)	Pack qty.
CWH600	4 - 7 and 4 - 7	10
CWH602	4 - 7 and 7 - 12	10
CWH604	7 - 12 and 7 - 12	10
CWH606	4 - 7 and 10 - 15	10
CWH608	7 - 12 and 10 - 15	10
CWH610	10 - 15 and 10 - 15	10



### Connectors, non-return valves, polypropylene



- Designed for use in vacuum lines and fluid handling systems
- Useful for preventing back pressure in filter flasks
- Printed arrow indicates the direction of flow
- Rigid with stepped tapered arms to give firm grip on tubing

Product Code	O.D. (mm)	Pack qty.
NWH902P	6 - 8	5
NWH905P	8 - 10	5
NWH906P	11 - 15	5



# Containers



## Containers, gallipots, polypropylene



- Low form dishes made from medical grade polypropylene
- Suitable for sampling, short term storage, micro-analysis or many other applications
- Moulded graduations to capacity
- 60ml pots are available sterile in individually wrapped vac packs
- Non-sterile versions are autoclavable to 121°C

Product Code	Capacity (ml)	Description	Packaging	Pack qty.
GWY520	60	Non-sterile	Bulk	1000
GWY524	60	Sterile	Individually wrapped	400
GWY526	120	Non-sterile	Bulk	1000
GWY528	250	Non-sterile	Bulk	750



## Containers, gallipot, tray, 3 compartment, polypropylene



- 3 compartment tray with 2 integral gallipots
- Made from medical grade polypropylene
- Suitable for sampling, short term storage, micro-analysis or any other applications
- Non-sterile - can be autoclavable at 121°C

Product Code	Dimensions (h x l x w) (mm)	Pack qty.
GWY530	28 x 196 x 130	200



## Medicine measures, polypropylene



- Translucent and robust graduated medicine measures
- Made from medical grade polypropylene
- Nest to save space
- Ideal for use when taking pH measurements

Product Code	Capacity (ml)	Grads. (ml)	O.D. (mm)	Height (mm)	Pack qty.
MWY514	30	1.0	37	42	1000
MWY518	50	5.0	50	53	1000

## Containers, screw cap, polypropylene



- Useful wide neck containers with liner-less screw caps
- Good chemical resistance
- Ideal for storage of samples, powders, etc.

Product Code	Capacity (ml)	O.D. x height (mm)	Pack qty.
JWP0030P	30	43 x 43	72
JWP0060P	60	53 x 47	48
JWP0125P	125	70 x 60	36
JWP0250P	250	89 x 66	36
JWP0500P	500	89 x 97	24
JWP0950P	950	120 x 100	24
JWP1200P	1200	120 x 132	24



## Containers, snap-on lid, polypropylene



- Useful lightweight tapered containers with tight fitting LDPE lids
- Good chemical resistance
- Ideal for storage of samples, powders, etc.
- JWH0125P and JWH5000P are manufactured from HDPE
- Suitable for food contact applications in accordance with USA regulations

Product Code	Capacity (ml)	O.D. x height (mm)	Pack qty.
JWH0125P	125	80 x 40	250
JWH0250P	250	70 x 70	250
JWH0500P	500	70 x 90	100
JWH1000P	1000	90 x 120	100
JWH2000P	2000	140 x 150	50
JWH2500P	2500	170 x 150	25
JWH5000P	5000	200 x 210	25



## Containers, specimen, LDPE



- Containers with captive hinged cap suitable for many applications
- Lightweight and unbreakable in normal use
- Can withstand temperatures up to 80°C

Product Code	Capacity (ml)	O.D. x height (mm)	Pack qty.
BGG302	1	8 x 38	20
BGG304	2.5	12 x 40	20
BGG306	5	15 x 49	20
BGG308	10	28 x 32	10
BGG311	20	32 x 36	10
BGG312	25	25 x 78	10

## Containers, specimen, polystyrene



- Clear polystyrene containers with maximum sample visibility
- Polyethylene airtight snap-on lids for quick easy use

Product Code	Capacity (ml)	O.D. x height (mm)	Pack qty.
BGG440P	10	26 x 28	10
BGG442P	20	32 x 33	10
BGG444P	30	36 x 33	10
BGG446P	50	36 x 53	10
BGG450P	100	51 x 60	10
BGG452P	150	65 x 53	10
BGG454P	200	65 x 68	10
BGG456P	250	65 x 85	5
BGG458P	500	100 x 100	5

## Crucibles, Gooch

PYREX®

- Ideal for drying precipitates to constant mass at 110°C
- Also suitable for ignition work up to 450°C (see safety notice)
- With integral glass sintered disc
- Manufactured from chemically resistant Pyrex® borosilicate glass

Product Code	Nom. capacity (ml)	Sintered disc diam. (mm)	Porosity grade	Overall height (mm)	Pack qty.
3650/02M	10	20	1	45	5
3650/04M	10	20	2	45	5
3650/06M	10	20	3	45	5
3650/08M	10	20	4	45	5
3660/02M	30	30	1	53	5
3660/04M	30	30	2	53	5
3660/06M	30	30	3	53	5
3660/08M	30	30	4	53	5
3660/10M	30	30	5	53	5
3680/02M	60	40	1	65	5
3680/04M	60	40	2	65	5
3680/06M	60	40	3	65	5
3680/08M	60	40	4	65	5
3680/10M	60	40	5	65	5



 Avoid sudden changes in temperature which can result in thermal breakage. For high temperature ignition work, use a furnace and slowly heat to 450°C maximum. Allow to cool below 200°C before removing from the furnace.

## Crucible Adapter

PYREX®

- Allows Gooch crucibles to be fitted to a Büchner filter flask
- Useful for filtering and washing precipitates prior to drying

Product Code	To fit crucible	Open end I.D. (mm)	Height excluding stem (mm)	Stem O.D. (mm)	Stem length (mm)	Pack qty.
3690/02M	3650:	30	60	9	75	10
3690/04M	3660:	37	68	9	75	10
3690/08M	3680:	47	78	9	75	10

 For fitting a crucible onto the adapter, it is necessary to use a rubber cone as detailed on page 110.



# Crucibles, cutting board



## Rubber cones

*Azlon*

- For mounting Gooch crucibles onto Adapters 3690: series
- Manufactured from natural rubber
- Set of six sizes; 15, 22, 28, 36, 42 and 52mm I.D. at top
- May also be used for mounting filter funnels into Büchner flasks

Product Code	Description	Pack qty.
CON0006A	Set of 6 cones	1



## Cutting board, polypropylene

*A E Azlon*

- Autoclavable at 121°C
- Good chemical resistance
- Unbreakable in normal use
- Non-absorbent and easy to clean

Product Code	Overall dim. l x b x h mm	Pack qty.
BWY300	300 x 210 x 9	1

## Cylinders, with spout, class A, works certified

PYREX®

- Complies with ISO 4788
- Calibrated to Class A tolerances
- Individually tested and supplied with certificate showing exact volume contained at 5 points on the scale
- Conformity 'H' certified
- Printed with individual serial number for traceability to National Standards.
- Graduations in white enamel
- Manufactured from chemically resistant borosilicate glass with hexagonal foot

Product Code	Capacity (ml)	Grads. (ml)	Tol. (+/- ml)	Max. height (mm)	Pack qty.
3201/02WC*	5	0.1	0.05	115	2
3201/04WC*	10	0.2	0.10	140	2
3201/06WC	25	0.5	0.25	170	2
3201/08WC	50	1.0	0.50	200	2
3201/10WC*	100	1.0	0.50	260	2
3201/12WC*	250	2.0	1.00	335	2
3201/14WC	500	5.0	2.50	365	2
3201/16WC	1000	10.0	5.00	465	2
3201/18WC	2000	20.0	10.00	505	1



\* conforms with USP requirements.

## Cylinders, with spout, class A

PYREX®

- Complies with ISO 4788
- Calibrated to Class A tolerances
- Conformity 'H' certified
- Printed with serial number for downloadable batch certificate
- Graduations in white enamel
- Manufactured from chemically resistant Pyrex® borosilicate glass

Product Code	Capacity (ml)	Grads. (ml)	Tol. (+/- ml)	Max. height (mm)	Pack qty.
3201/02	5	0.1	0.05	115	2
3201/04	10	0.2	0.10	140	2
3201/06	25	0.5	0.25	170	2
3201/08	50	1.0	0.50	200	2
3201/10	100	1.0	0.50	260	2
3201/12	250	2.0	1.00	335	2
3201/14	500	5.0	2.50	365	2
3201/16	1000	10.0	5.00	465	2
3201/18	2000	20.0	10.00	505	1



Batch certificates can be downloaded for free at [www.scilabware.com](http://www.scilabware.com). UKAS certified cylinders are available on request.



# Cylinders



## Cylinders, blue graduations, class B

**MBL®**

- Complies with ISO 4788
- Easy to read graduations in blue enamel
- Manufactured in chemically resistant borosilicate glass
- Robust hexagonal foot

Product Code	Capacity (ml)	Grads. (ml)	Tol. (+/- ml)	Max. height (mm)	Pack qty.
CRC201	5	0.1	0.1	115	2
CRC202	10	0.2	0.2	140	2
CRC204	25	0.5	0.5	170	2
CRC206	50	1.0	1.0	200	2
CRC209	100	1.0	1.0	260	2
CRC211	250	2.0	2.0	335	2
CRC213	500	5.0	5.0	365	2
CRC214	1000	10.0	10.0	465	2
CRC216	2000	20.0	20.0	505	1



## Cylinders, white graduations, class B

**PYREX®**

- Complies with ISO 4788
- Manufactured to Class B tolerances
- Robust hexagonal foot
- White enamel graduations which remain visible when using dark coloured solutions
- Manufactured from chemically resistant borosilicate glass

Product Code	Capacity (ml)	Grads. (ml)	Tol. (+/- ml)	Max. height (mm)	Pack qty.
3200/02MP	5	0.1	0.1	115	2
3200/04MP	10	0.2	0.2	140	2
3200/06MP	25	0.5	0.5	170	2
3200/08MP	50	1.0	1.0	200	2
3200/10MP	100	1.0	1.0	260	2
3200/12MP	250	2.0	2.0	335	2
3200/14MP	500	5.0	5.0	365	2
3200/16MP	1000	10.0	10.0	465	2
3200/18MP	2000	20.0	20.0	505	1

## Cylinders, tall form, heavy duty rim, class B

PYREX®

- Complies to ISO 4788
- Heavy duty construction for increased mechanical strength and longer life:
  - Heavily beaded rim and spout
  - Robust hexagonal foot
- Graduations in highly contrasting blue enamel
- Manufactured from Pyrex® borosilicate glass for high resistance to chemical attack

Product Code	Capacity (ml)	Grads. (ml)	Tol. (+/- ml)	Max. height (mm)	Pack qty.
3280-50	50	1.0	1.0	196	2
3280-100	100	1.0	1.0	256	2
3280-250	250	2.0	2.0	331	2
3280-500	500	5.0	5.0	360	2
3280-1L	1000	10.0	10.0	460	2
3280-2L	2000	20.0	20.0	500	1



## Cylinders, squat form, heavy duty rim, class B

PYREX®

- Complies with ISO 4788
- Squat height - more stable
- Heavy duty construction for increased mechanical strength and longer life:
  - Heavily beaded rim and spout
- More convenient to use in confined spaces - e.g. fume cupboards
- Graduations in blue enamel
- Manufactured from Pyrex® borosilicate glass

Product Code	Capacity (ml)	Grads. (ml)	Tol. (+/- ml)	Max. height (mm)	Pack qty.
3285-10	10	1.0	0.3	100	2
3285-25	25	1.0	0.5	125	2
3285-50	50	1.0	1.0	150	2
3285-100	100	2.0	1.0	170	2
3285-250	250	5.0	2.0	230	2
3285-500	500	10.0	5.0	255	2
3285-1L	1000	20.0	10.0	295	1





## Cylinders, with detachable foot, class B, complete cylinder

**PYREX®**

- Complies with ISO 4788
- Comprises Pyrex® glass cylinder and polyethylene foot
- Glass cylinder has white enamel graduations
- Polyethylene foot absorbs impact and reduces breakage
- Replacement feet available separately

Product Code	Capacity (ml)	Grads. (ml)	Tol. (+/- ml)	Approx overall height (mm)	Pack qty.
3205/04MP	10	0.2	0.2	150	2
3205/06MP	25	0.5	0.5	175	2
3205/08P	50	1.0	1.0	195	2
3205/10P	100	1.0	1.0	270	2
3205/12P	250	2.0	2.0	320	2

## Spare plastic feet

Product Code	Description	Pack qty.
4500/00	To fit cylinder capacity: 10ml	10
4500/01	To fit cylinder capacity: 25ml	10
4500/02M	To fit cylinder capacity: 50ml	10
4500/04M	To fit cylinder capacity: 100ml	10
4500/06M	To fit cylinder capacity: 250ml	10

### Cylinders, hexagonal foot, white graduations, class A, works certified

**PYREX®**

- Complies with ISO 4788
- Calibrated to Class A tolerances
- Individually tested and supplied with certificate showing exact volume contained at 5 points on the scale
- Conformity 'H' certified
- Printed with individual serial number for batch certification
- Manufactured from chemically resistant Pyrex borosilicate glass with hexagonal glass
- Graduations in white enamel for improved visibility with dark coloured solutions
- Supplied with polyethylene stopper

Product Code	Capacity (ml)	Grads. (ml)	Tol. (+/- ml)	Stopper size	Max. height (mm)	Pack qty.
3212/04WC	10	0.2	0.10	10/19	159	2
3212/06WC	25	0.5	0.25	14/23	193	2
3212/08WC	50	1.0	0.50	19/26	226	2
3212/10WC	100	1.0	0.50	24/29	291	2
3212/12WC	250	2.0	1.00	29/32	367	2
3212/14WC	500	5.0	2.50	34/35	403	2
3212/16WC	1000	10.0	5.00	45/40	505	2
3212/18WC	2000	20.0	10.00	45/40	545	1



For spare polyethylene stoppers refer to page 258.



Batch certificate is available as a free download at [www.scilabware.com](http://www.scilabware.com).

### Cylinders, hexagonal foot, white graduations, class A PYREX®

- Complies with ISO 4788
- Printed with a batch code for a downloadable batch certificate
- Manufactured from chemically resistant Pyrex borosilicate glass
- Graduations in white enamel for improved visibility with dark coloured solutions
- Supplied with polyethylene stopper
- Robust hexagonal glass foot

Product Code	Capacity (ml)	Grads. (ml)	Tol. (+/- ml)	Stopper size	Max. height (mm)	Pack qty.
3212/04	10	0.2	0.10	10/19	159	2
3212/06	25	0.5	0.25	14/23	193	2
3212/08	50	1.0	0.50	19/26	226	2
3212/10	100	1.0	0.50	24/29	291	2
3212/12	250	2.0	1.00	29/32	367	2
3212/14	500	5.0	2.50	34/35	403	2
3212/16	1000	10.0	5.00	45/40	505	2
3212/18	2000	20.0	10.00	45/40	545	1



For spare polyethylene stoppers refer to page 258.



Batch certificate is available as a free download at [www.scilabware.com](http://www.scilabware.com).

# Cylinders



## Cylinders, with plastic stopper, hexagonal foot, white graduations, class B

**PYREX®**

- Complies with ISO 4788
- Supplied with interchangeable polyethylene stopper
- Graduations in white enamel for improved visibility with dark coloured solutions
- Manufactured in chemically resistant Pyrex® borosilicate glass
- Robust hexagonal foot

Product Code	Capacity (ml)	Grads. (ml)	Tol. (+/- ml)	Stopper size	Max. height (mm)	Pack qty.
3211/04MP	10	0.2	0.2	10/19	159	2
3211/06MP	25	0.5	0.5	14/23	193	2
3211/08MP	50	1.0	1.0	19/26	226	2
3211/10MP	100	1.0	1.0	24/29	291	2
3211/12MP	250	2.0	2.0	29/32	367	2
3211/14MP	500	5.0	5.0	34/35	403	2
3211/16MP	1000	10.0	10.0	45/40	505	2
3211/18MP	2000	20.0	20.0	45/40	545	1



For spare polyethylene stoppers refer to page 258.



## Cylinders, with plastic stopper, hexagonal foot, blue graduations, class B

**MBL®**

- Complies with ISO 4788
- Supplied with polyethylene stopper
- Graduations in easy to read blue enamel
- Manufactured from borosilicate glass
- Robust hexagonal foot

Product Code	Capacity (ml)	Grads. (ml)	Tol. (+/- ml)	Stopper size	Max. height (mm)	Pack qty.
CRC302	10	0.2	0.2	10/19	159	2
CRC304	25	0.5	0.5	14/23	193	2
CRC306	50	1.0	1.0	19/26	226	2
CRC308	100	1.0	1.0	24/29	291	2
CRC310	250	2.0	2.0	29/32	367	2
CRC312	500	5.0	5.0	34/35	403	2
CRC314	1000	10.0	10.0	45/40	505	2
CRC316	2000	20.0	20.0	45/40	545	1

## Cylinders, with plastic stopper and detachable foot, PYREX® class B, complete cylinder

- Complies with ISO 4788
- Comprises borosilicate glass cylinder polyethylene foot and polyethylene stopper
- Replacement parts available separately
- Graduations in white enamel

Product Code	Capacity (ml)	Grads. (ml)	Tol. (+/- ml)	Stopper size	Max. height (mm)	Pack qty.
3215/06MP	25	0.5	0.5	14/23	175	2
3215/08P	50	1.0	1.0	19/26	195	2
3215/10P	100	1.0	1.0	24/29	270	2
3215/12P	250	2.0	2.0	29/32	320	2

 For further details on spare plastic feet see page 114.



## Cylinders, Nessler

- For colour comparison of water samples etc.
- Manufactured from borosilicate tubing specially selected for freedom from colour or visible defects
- Cylinder bases are formed by a technique which gives maximum clarity
- Supplied in matched pairs for uniformity

Product Code	Capacity (ml)	Grads. (ml)	Tol. (+/- ml)	O.D. x height (mm)	Pack qty.
CRC320	50	50	0.4	26 x 150	2
CRC322	100	50 & 100	0.8	34 x 180	2

**MBL®**



## Cylinders, Crow Receiver, class B

- Complies with BS 658
- For the collection of distillate in oil and tar tests
- Graduations in white enamel
- Manufactured from Pyrex® borosilicate glass

Product Code	Capacity (ml)	Grads. (ml)	Overall height (mm)	Pack qty.
3400/04	100	1	250	2

**PYREX®**



# Cylinders



## Cylinders, printed graduations, class A, PMP (TPX)



- Calibrated to ISO 6706 and DIN 12681, class A tolerances
- Steam sterilisation at 121°C does not affect accuracy
- Supplied with conformity certificate
- Enhanced pin sharp blue printed graduations
- Stable hexagonal bases with non-slip anti-suction feature

Product Code	Capacity (ml)	Grads. (ml)	Tol. (+/- ml)	Height (mm)	Pack qty.
CTA0010P	10	0.2	0.1	145	2
CTA0025P	25	0.5	0.2	170	2
CTA0050P	50	1.0	0.5	200	2
CTA0100P	100	1.0	0.5	250	5
CTA0250P	250	2.0	1.0	315	1
CTA0500P	500	5.0	2.5	360	1
CTA1000P	1000	10.0	5.0	440	1
CTA2000P	2000	20.0	10.0	535	1



## Cylinders, printed graduations, class B, PMP (TPX)



- Calibrated to ISO 6706 and DIN 12681, class B tolerances
- Steam sterilisation at 121°C does not affect accuracy
- Enhanced pin sharp blue printed graduations
- Stable hexagonal bases with non-slip anti-suction feature

Product Code	Capacity (ml)	Grads. (ml)	Tol. (+/- ml)	Height (mm)	Pack qty.
CTB0010P	10	0.2	0.2	145	10
CTB0025P	25	0.5	0.5	170	5
CTB0050P	50	1.0	1.0	200	5
CTB0100P	100	1.0	1.0	250	5
CTB0250P	250	2.0	2.0	315	1
CTB0500P	500	5.0	5.0	360	1
CTB1000P	1000	10.0	10.0	440	1
CTB2000P	2000	20.0	20.0	535	1

**Cylinders, moulded graduations, class B, PMP (TPX)**

- Conform to ISO 6706
- Transparent robust PMP
- Good chemical resistance
- Large pouring spout for easy dispensing
- Autoclavable to 121°C

Product Code	Capacity (ml)	Grads. (ml)	Tol. (+/- ml)	Height (mm)	Pack qty.
CT0010P	10	0.2	0.2	145	10
CT0025P	25	0.5	0.5	170	5
CT0050P	50	1.0	1.0	200	5
CT0100P	100	1.0	1.0	250	5
CT0250P	250	2.0	2.0	315	1
CT0500P	500	5.0	5.0	360	1
CT1000P	1000	10.0	10.0	440	1
CT2000P	2000	20.0	20.0	535	1

**Cylinders, printed graduations, class B, polypropylene**

- Conform to ISO 6706
- Clear pin sharp blue graduations
- Ultra clear polypropylene with good chemical resistance
- Stable hexagonal bases with non slip anti-suction feature

Product Code	Capacity (ml)	Grads. (ml)	Tol. (+/- ml)	Height (mm)	Pack qty.
CPB0010P	10	0.2	0.2	145	10
CPB0025P	25	0.5	0.5	170	10
CPB0050P	50	1.0	1.0	200	10
CPB0100P	100	1.0	1.0	250	5
CPB0250P	250	2.0	2.0	315	1
CPB0500P	500	5.0	5.0	360	1
CPB1000P	1000	10.0	10.0	440	1
CPB2000P	2000	20.0	20.0	535	1



Exposure to temperatures above 80°C may affect accuracy. Cleaning temperatures below 60°C are recommended to preserve marks and inscriptions.



# Cylinders



**i** Exposure to temperatures above 80°C may affect accuracy.

## Cylinders, moulded graduations, class B, polypropylene



- Conform to ISO 6706
- Ultra clear polypropylene with good chemical resistance
- Large pouring spout for easy dispensing
- Stable hexagonal bases with non slip anti-suction feature
- Permanent moulded graduations

Product Code	Capacity (ml)	Grads. (ml)	Tol. (+/- ml)	Height (mm)	Pack qty.
CP0010P	10	0.2	0.2	145	10
CP0025P	25	0.5	0.5	170	10
CP0050P	50	1.0	1.0	200	10
CP0100P	100	1.0	1.0	250	5
CP0250P	250	2.0	2.0	315	1
CP0500P	500	5.0	5.0	360	1
CP1000P	1000	10.0	10.00	440	1
CP2000P	2000	20.0	20.0	535	1

## Cylinders, moulded graduations, set, class B, polypropylene

Product Code	Description	Pack qty.
NB1203	Set of 6 cylinders comprising (1x 10, 25, 50, 100, 250 & 500ml)	1



## Cylinders, squat form, class B, polypropylene



- Squat design for increased stability on the bench and ease of handling particularly in restricted spaces
- Unique self-draining base eliminating water collection during washing in an automatic laboratory washing machine, thereby removing all spill and contamination issues
- Moulded, blue over-printed graduations
- Manufactured from high clarity polypropylene
- Good chemical and temperature resistance
- Anti-suction base stops cylinders slipping on a wet surfaces

Product Code	Capacity (ml)	Grads. (ml)	Tol. (+/- ml)	Height (mm)	Pack qty.
CPS0100P	100	2.0	2.0	163	5
CPS0250P	250	5.0	5.0	192	1
CPS0500P	500	10.0	10.0	218	1
CPS1000P	1000	20.0	20.0	285	1

**i** Exposure to temperatures up to 80°C will not cause permanent exceeding of tolerance limits. Cleaning temperatures below 60°C are recommended to preserve marks and inscriptions.

## Desiccators, non-vacuum

PYREX®

- Robust desiccator base and cover in borosilicate glass
- Simple design for drying under atmospheric pressure
- Ground glass flanges
- Choice of 2 sizes - to accommodate 150mm or 200mm diameter plates
- Plates are positioned on an internal ledge within the base
- Accessory metal perforated plate available

Product Code	Description	Flange I.D. (mm)	Plate size (mm)	Height, ledge to flange (mm)	Pack qty.
1590/02D	Complete desiccator	170	150	85	1
1590/04D	Spare cover	170	-	0	1
1590/06D	Spare base	170	150	85	1
1591/02D	Complete desiccator	220	200	120	1
1591/04D	Spare cover	220	-	0	1
1591/06D	Spare base	220	200	120	1



 Complete desiccators consist of a base and cover. Not supplied with metal perforated plate. See page 122 for information on this product.

## Desiccators, vacuum

PYREX®

- Designed for use under vacuum
- Sturdy construction in borosilicate glass
- Ground glass flanges
- Cover has a 24/29 socket to accept desiccator stopcocks
- Choice of 2 sizes - to accommodate 150mm or 200mm diameter plates
- Plates are positioned on an internal ledge within the base
- Accessory metal perforated plate and Rotaflo® glass/PTFE stopcock available

Product Code	Description	Flange I.D. (mm)	Plate size (mm)	Height, ledge to flange (mm)	Socket size	Pack qty.
1593/02D	Complete desiccator	170	150	85	24/29	1
1593/04D	Spare cover	170	-	-	24/29	1
1594/02D	Complete desiccator	220	200	120	24/29	1
1594/04D	Spare cover	220	-	-	24/29	1



 Complete desiccators consist of a base, cover and stopcock. Not supplied with metal perforated plate.

# Desiccators



## Desiccator plate

- Metal perforated plate for use with Pyrex® vacuum and non-vacuum desiccators

Product Code	Plate size (mm)	Pack qty.
1597/02D	150	1
1597/04D	200	1



## Desiccator stopcock

- For use with Pyrex® vacuum desiccators
- With Rotaflo® stopcock for vacuum tight seal

Product Code	Joint size	Pack qty.
1612/03	24/29	1

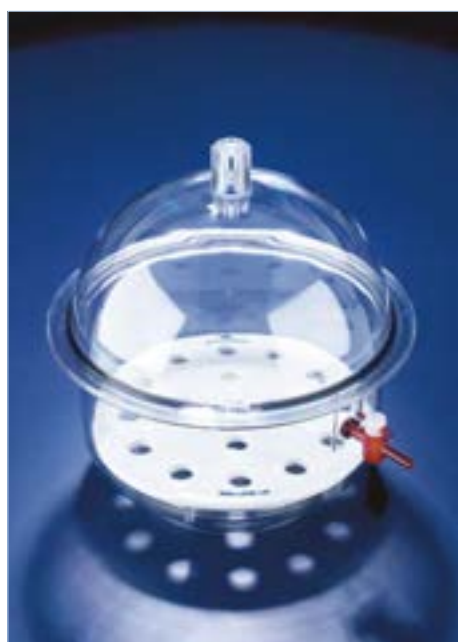

## Desiccators, vacuum, polycarbonate



- Transparent polycarbonate cover and base
- Durable with high impact resistance
- Will safely withstand high vacuum pressures
- Ceramic plate permits the use of incandescent crucibles

Product Code	Description	I.D. (mm)	Plate size (mm)	Overall height (mm)	Effective inside height (mm)	Pack qty.
DWA215	With Stopcock	215	205	262	178	1
DWA245	With Stopcock	245	236	296	195	1

## Desiccators, vacuum, polycarbonate, spares

Product Code	Description	Pack qty.
DWA205	Spare plate for DWA 215	1
DWA236	Spare plate for DWA245/246	1
DWA510	Spare stopcock for DWA215/245	1

## Desiccator, cabinet, polystyrene



- Provides moisture-proof storage
- Clear high impact polystyrene cabinet
- Space saving stacking feature
- Airtight door made from acrylonitrile-styrene with foam rubber gasket
- Supplied with sealed jar of silica gel

Product Code	Int. l x w x h (mm)	Ext. l x w x h (mm)	Door opening (mm)	Pack qty.
DWA301	190 x 175 x 110	225 x 208 x 170	188 x 110	1



Not suitable for vacuum use or filling with gases.



## Dilatometer



- For measuring the expansion in volume of edible oils and fats over a temperature range within which melting takes place
- Dilatometer body is graduated with an arbitrary scale, from 0 - 0.9ml
- Graduated at every 0.005ml with clear figures every 0.05ml
- Chamber is filled with oil or fat and the meniscus should be settled on zero when the stopper is in place at starting temperature
- Interchangeable stopper has open top to allow weighting with steel balls etc.

Product Code	Description	Socket size	Cone size	Pack qty.
SB14DL	Stopper	-	14/23	1
WE12/1	Dilatometer body	14/23	-	1



## Crystallising dishes, flat bottom

**PYREX®**

- Complies to DIN 12337
- Manufactured from Pyrex® borosilicate glass
- Suitable for use up to 400°C
- Chemically and thermally resistant

Product Code	Capacity (ml)	Diam. (mm)	Height (mm)	Pack qty.
1470/03M	15	40	25	10
1470/00M	30	52	30	10
1470/01M	60	58	35	10
1470/02D	100	70	40	10
1470/04D	150	80	45	10
1470/08D	300	95	55	10
1470/10D	500	115	65	10
1470/12D	900	140	75	10
1470/16D	2000	190	90	10

## Crystallising dishes, flat bottom, with spout

**PYREX®**

- Complies to DIN 12338
- Manufactured from Pyrex® borosilicate glass
- Suitable for use up to 400°C
- Chemically and thermally resistant

Product Code	Capacity (ml)	Diam. (mm)	Height (mm)	Pack qty.
1471/03M	15	40	25	10
1471/00M	30	52	30	10
1471/01M	60	58	35	10
1471/02M	100	70	40	10
1471/04M	150	80	45	10
1471/08M	300	95	55	10
1471/10M	500	115	65	10
1471/12M	900	140	75	10
1471/16M	2000	190	90	10



## Evaporating dishes

- Complies to DIN 12336
- Manufactured from Pyrex® borosilicate glass
- High resistance to chemical attack and thermal shock
- Flat base
- Curved sides with spout

Product Code	Capacity (ml)	Diam. (mm)	Height (mm)	Pack qty.
1450/01D	15	50	25	10
1450/03D	45	60	30	10
1450/04D	90	80	45	10
1450/06D	170	95	55	10
1450/10D	320	115	65	10
1450/14D	600	140	80	10

 1450/01D, 1450/03D & 1450/04D are unbadged.

**PYREX®**



## Dishes, general purpose

- Manufactured from chemically resistant Pyrex® borosilicate glass
- Ideal for numerous applications:
  - Drying powders and crystals
  - Staining and development
  - Collection of drips and spills from solution bottles
  - Gel electrophoresis and paper chromatography
  - Dissection work
- Dishes can be autoclaved or used in microwave ovens

Product Code	Capacity (ml)	Length (mm)	Width (mm)	Height (mm)	Pack qty.
1490/02	2000	262	199	57	4
1490/04	1500	228	215	60	4
1490/06	3500	312	232	55	4
1490/08	4500	366	266	55	4

 Dimensions are approximate.

**PYREX®**





## Pestle

**PYREX®**

- Ideal for crushing solids into powders for easier handling
- Manufactured from Pyrex® borosilicate glass for highest resistance to thermal shock and chemical corrosion
- Available in a rough or glazed finish
- For use with Pyrex® Mortars

Product Code	Finish	Length (mm)	Pack qty.
718342	Rough	110	1
718342R	Glazed	110	1
718347	Rough	125	1
718347R	Glazed	125	1

**i** Pestles and mortars should be ordered separately.

## Mortar

**PYREX®**

- Manufactured from Pyrex® borosilicate glass for highest resistance to thermal shock and chemical corrosion
- For use with Pyrex® Pestle
- Ideal for preparing compounds, mixing and grinding powders

Product Code	Capacity (ml)	O.D. (mm)	Height (mm)	Pack qty.
718234	100	80	60	1
718242	120	100	75	1
718247	300	120	90	1



## Petri dishes

**PYREX®**

- Specially formed to ensure even wall thickness and consistent optical performance
- Will withstand repeated autoclaving
- Manufactured from chemically resistant Pyrex® borosilicate glass

Product Code	Size (mm)	Base ext. dia (mm)	Cover int. dia (mm)	Pack qty.
1480/02D	60 x 20	54	55	10
1480/06D	80 x 20	74	75	10
1480/08D	100 x 20	94	95	10
1480/10D	120 x 20	114	115	10
1480/12D	150 x 30	143	145	10

## Dispensers, tilt measure, variable volume



- Ideal for dispensing fixed volumes of liquids
- Very easy to use
  - Tilt the unit backwards to fill
  - Tilt the unit forwards to dispense
- Accuracy of  $\pm 5\%$  can be achieved
- Fits any vessel with a 24/29 socket
- Manufactured from chemically resistant borosilicate glass

Product Code	To accept inner measures (ml)	Cone size	Thread size (mm)	Pack qty.
TM28/23	5ml o 10ml	24/29	28	1
TM28/43	20ml o 25ml	24/29	28	1



## Inner tilt measures

Product Code	Capacity (ml)	Pack qty.
TM11/5	5	1
TM11/10	10	1
TM11/20	20	1
TM11/25	25	1



Comprises outer body which accepts choice of inner measures: TM28/23 for use with either 5ml or 10ml inner measures or TM28/43 for use with either 20ml or 25ml inner measures.

## Extractors, Soxhlet



- Conforms to BS 2071
- For extracting soluble components or impurities from solids via repeated soaking/siphoning with solvent
- Wide choice of extractors to accommodate most sizes of sample and thimbles
- Accurately formed concentric siphon tube for reliable performance

Product Code	Nom. capacity (siphoning vol.) (ml)	Socket size	Cone size	Approx overall height (mm)	Pack qty.
EX5/21	6	19/26	14/23	150	1
EX5/32	20	24/29	19/26	175	1
EX5/43	40	29/32	24/29	200	1
EX5/53	60	34/35	24/29	205	1
EX5/55	60	34/35	34/35	205	1
EX5/55/100	100	34/35	34/35	240	1
EX5/63	100	40/38	24/29	220	1
EX5/83	200	50/42	24/29	250	1



Approximate overall height is measured from the wide end of the cone.



# Extractors



## Extractors, Soxhlet, large capacity



- Conforms to BS 2071
- Large capacity extractors
- With flat flange joints to permit introduction of large samples
- Used in conjunction with flat flange lid and retaining clip which should be ordered separately

Product Code	Nom. capacity (siphoning vol.) (ml)	Extractor flange size (mm)	Extractor cone size	Pack qty.
EX5/75	600	75	34/35	1
EX5/105	2000	100	34/35	1

## Lids for large capacity Soxhlet extractor

Product Code	Description	Socket size	Pack qty.
DA5/75	Lid for EX5/75	34/35	1
DA5/100	Lid for EX5/105	34/35	1

## Metal clip for large capacity Soxhlet extractor

Product Code	Description	Pack qty.
JC75F	Metal clip for EX5/75	1
JC100F	Metal clip for EX5/105	1



## Extractors, plain body



- Designed for use in reflux assemblies so that solvent vapour permeates directly through the material to be extracted then condenses and washes back into the flask
- Sample can be supported directly on glass spiral or in a paper or glass thimble

Product Code	Nom. capacity (ml)	Socket size	Cone size	Approx overall height (mm)	Pack qty.
EX7/13	60	34/35	24/29	205	1
EX7/33	200	55/44	24/29	250	1



Approximate overall height is measured from the wide end of the cone.



Take care that the sample or thimble does not totally block the passage of rising vapour and falling condensate.

## Extractors, spiral support



Product Code	Description	Diam. (mm)	Pack qty.
EX13/25	To fit EX7/13	29	1
EX13/26	To fit EX7/33	35	1

## Extractors, paper thimbles

- Paper thimbles are the most common type used in liquid/solid extractors and although not available from SciLabware, are readily obtained from most laboratory suppliers. Recommended sizes for the Quickfit® range of extractors are as follows:

Product Code	Recommended thimble size (mm)	Pack qty.
EX5/21	10 x 50	1
EX5/32	18 x 65	1
EX5/43	22 x 80	1
EX5/53	28 x 80	1
EX5/55	28 x 80	1
EX5/55/100	28 x 120	1
EX5/63	33 x 100	1
EX5/75	60 x 180	1
EX5/83	41 x 123	1
EX5/105	70 x 240	1
EX7/13	27 x 100	1
EX7/33	33 x 100	1



The dimensions are internal and are given for single thickness thimbles only. If double thickness thimbles are used, the internal diameter should be 2mm less to allow for greater wall thickness. Alternatively, thimbles made from borosilicate glass are available below.

## Glass thimbles

**PYREX®**

- Borosilicate glass with sintered glass disc to support solid sample
- Highly resistant to chemical attack
- Useful for chemical applications where it is required to weigh the extracted material

Product Code	Porosity grade	Disc diam. (mm)	O.D. (mm)	Overall length (mm)	Pack qty.
3840/02M	1	20	26	95	5
3845/02M	1	30	36	95	5



3840: thimbles fit Quickfit® extractors EX5/53 and EX5/55. 3845: thimbles fit Quickfit® extractors EX5/63 and EX5/83.



## Extractors, Soxhlet, complete assemblies



- Each assembly comprises the basic components for solid-liquid extraction : Flask/Soxhlet extractor/Condenser/Associated lids and clips
- Choice of 7 assemblies with extractor capacities from 20ml to 2000ml

Product Code	Nom. capacity (ml)	Components extractor etc	Flask	Condenser	Pack qty.
25RASX	20	EX5/32	FR50/2S	CX7/03/SC	1
40RASX	40	EX5/43	FR100/3S	CX7/04/SC	1
60RASX	60	EX5/53	FR150/3S	CX7/05/SC	1
100RASX	100	EX5/63	FR250/3S	CX7/06/SC	1
200RASX	200	EX5/83	FR500/3S	CX7/08/SC	1
600RDSX	600	EX5/75, DA5/75, JC75F	FR2L/5S	CX5/25/SC	1
2LRCSX	2000	EX5/105, DA5/100, JC100F	FR5L/5US	C13/55	1

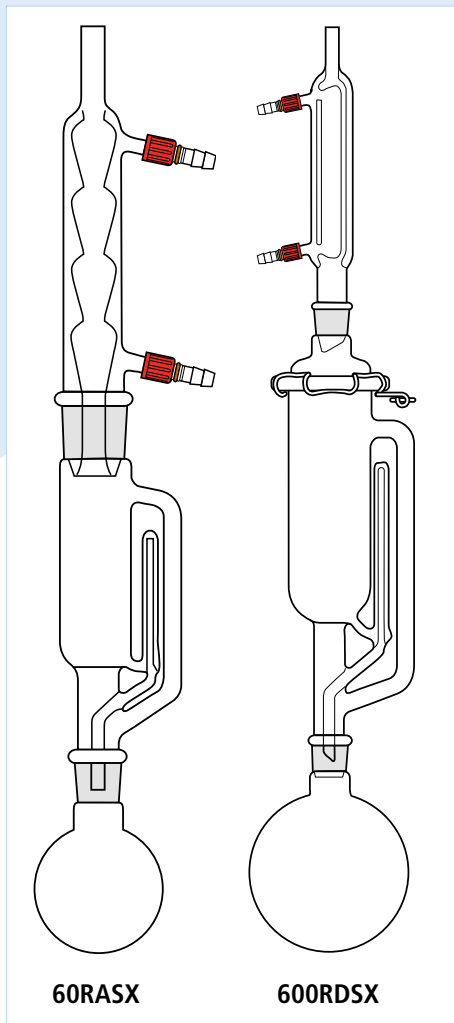



**ROTAFLO®**

**PYREX®**      **MBL®**

**CUSTOM GLASSWARE  
MANUFACTURE**

- Free quotation without obligation
- Highest quality guaranteed
- All enquiries welcome

Email: [customglass@scilabware.com](mailto:customglass@scilabware.com)



### Filter discs

- Complies with ISO 4793
- For use by Glassblowers constructing special apparatus
- Manufactured from Pyrex® borosilicate glass for resistance to heat and chemical corrosion
- Close control of pore size
- Accurate and consistent disc dimensions
- High mechanical strength to withstand full vacuum
- Convenient packaging



For further information regarding porosities, safe usage and cleaning please refer to the technical information section.

Product Code	Porosity grade	Nom. diam. (mm)	Pack qty.
3010/10M	0	10	10
3020/10M	0	20	10
3030/10M	0	30	10
3040/10M	0	40	10
3050/10M	0	50	10
3090/10M	0	90	1
3010/11M	1	10	10
3020/11M	1	20	10
3030/11M	1	30	10
3040/11M	1	40	10
3050/11M	1	50	10
3065/11M	1	65	1
3090/11M	1	90	1
3120/11M	1	120	1
3010/12M	2	10	10
3020/12M	2	20	10
3030/12M	2	30	10
3040/12M	2	40	10
3050/12M	2	50	10
3065/12M	2	65	1
3090/12M	2	90	1
3120/12M	2	120	1
3010/13M	3	10	10
3020/13M	3	20	10
3030/13M	3	30	10
3040/13M	3	40	10
3050/13M	3	50	10
3065/13M	3	65	1
3090/13M	3	90	1
3120/13M	3	120	1
3010/14M	4	10	10
3020/14M	4	20	10
3030/14M	4	30	10
3040/14M	4	40	10
3050/14M	4	50	10
3065/14M	4	65	1
3090/14M	4	90	1
3120/14M	4	120	1
3040/15M	5	40	10



## Filter holder, for 25mm membranes

**PYREX®**

- With porosity grade 3 sintered glass disc to support 25mm diameter membranes
- Liquids only in contact with chemically resistant borosilicate glass
- Comprises three components which should be ordered separately
  - Funnel 15ml capacity
  - Support base with sintered glass disc
  - Metal retaining clip
- Fully autoclavable

Product Code	Description	Pack qty.
5808/2	Funnel	1
5808/3	Base	1
9830/29M	Clip	1



## Filter holder, for 47mm membranes

**PYREX®**

- With sintered glass disc to support 47mm diameter membranes
- All borosilicate glass liquid pathway to avoid sample contamination
- Comprises three components which should be ordered separately
  - Funnel 300ml capacity
  - Support base with porosity grade 3 sintered glass disc
  - Metal retaining clip
- Fully autoclavable
- Ideal for microbiology

Product Code	Description	Pack qty.
5809/2	Funnel	1
5809/3	Base	1
5810/5	Clip	1

## Filtration system, for 47mm diameter membranes **PYREX®**

- All glass filtration system for use with 47mm diameter membranes
- Borosilicate glass porosity grade 3 sintered disc to support membrane
- Complete assembly comprises of four components
  - Funnel 300ml capacity
  - Support base with sintered disc and vacuum connection with 40/38 socket
  - 1000ml conical flask suitable for use under vacuum with 40/38 cone
  - Metal retaining clip
- Fully autoclavable
- Ideal for microbiology and preparation of HPLC solvents
- Each component is also available to order separately



Product Code	Description	Pack qty.	
5809/KIT	Complete assembly	1	<b>NEW</b>
5809/2	Funnel	1	
5810/3	Base	1	
5810/4	Flask	1	
5810/5	Clip	1	



## Filter pump

**MBL®**

- Provides a moderate vacuum (up to 65 mbar) when connected to a water supply
- Fitted with a non-return valve to prevent suck-back and flooding
- Manufactured from chemically resistant borosilicate glass

Product Code	Overall height (mm)	Body diam. (mm)	Pack qty.
FRF442	240	20	1

 Recommended water pressure = 1 bar. Approximate water consumption = 17 l/hr.





## Flasks, boiling, flat bottom, narrow neck

**PYREX®**

- Complies with DIN ISO 1773
- Flat base for standing on benches and hotplates etc.
- Manufactured from Pyrex® glass for high resistance to thermal shock
- Excellent chemical durability for contamination-free performance
- With white enamel marking spot

Product Code	Capacity (ml)	Height (mm)	Body diam. (mm)	Neck I.D. (mm)	Pack qty.
1070/02M	50	100	50	18	10
1070/04D	100	110	64	18	10
1070/12D	250	140	85	30	10
1070/18D	500	170	105	30	10
1070/24D	1000	200	131	36	10
1070/28D	2000	250	166	45	10
1070/32D	4000	300	207	45	1
1070/36D	6000	340	237	57	1
1070/38D	10000	360	280	57	1
1070/40D	12000	465	300	57	1
1070/42D	20000	558	341	60	1

**i** 12000ml and 20000ml flasks are supplementary to the ISO range.



## Flasks, boiling, flat bottom, wide neck

**PYREX®**

- Complies with DIN ISO 24450
- With wide neck to facilitate easy addition of solid samples etc.
- Flat base for standing on benches and hotplates etc.
- Manufactured from Pyrex® glass for high resistance to thermal shock
- Excellent chemical durability for contamination-free performance

Product Code	Capacity (ml)	Height (mm)	Bulb diam. (mm)	Neck I.D. (mm)	Pack qty.
1080/02M	50	75	52	32	10
1080/04M	100	100	64	32	10
1080/08D	250	140	84	47	10
1080/10D	500	170	103	47	10
1080/12D	1000	200	131	47	10
1080/14D	2000	230	166	76	10

## Flasks, boiling, round bottom, narrow neck

**PYREX®**

- Complies with DIN ISO 1773
- Manufactured from Pyrex® borosilicate glass which offers excellent resistance to chemical corrosion and thermal shock

Product Code	Capacity (ml)	Height (mm)	Bulb diam. (mm)	Neck I.D. (mm)	Pack qty.
1100/02M	50	105	50	18	10
1100/04M	100	115	65	18	10
1100/12D	250	144	85	30	10
1100/18D	500	175	105	30	10
1100/24D	1000	200	131	36	10
1100/28D	2000	260	166	45	10
1100/32D	4000	315	207	45	1
1100/35D	6000	355	236	57	1
1100/36D	10000	420	279	57	1
1100/38D	20000	515	345	67	1

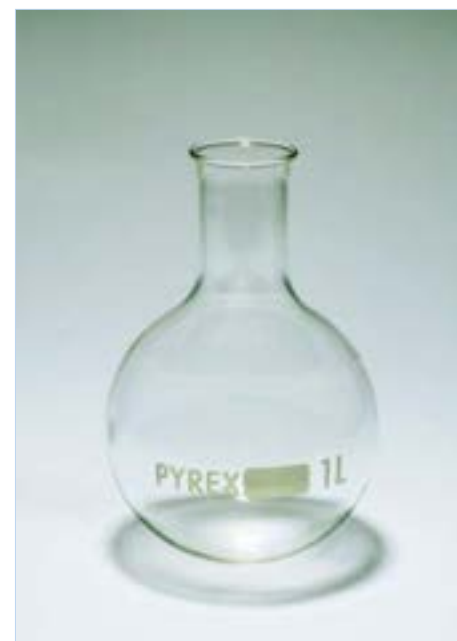

 20000ml flask is supplementary to the ISO range. For information on the safe heating of Pyrex® glassware, please see the care and maintenance of glassware section.

## Flasks, boiling, round bottom, wide neck

**PYREX®**

- Complies with DIN ISO 24450
- With wide neck to facilitate addition of solid samples etc.
- Pyrex® glass means highest resistance to chemical corrosion and thermal shock

Product Code	Capacity (ml)	Height (mm)	Bulb diam. (mm)	Neck I.D. (mm)	Pack qty.
1120/04M	100	100	65	30	10
1120/08D	250	145	85	46	10
1120/14D	500	168	105	46	10
1120/18D	1000	210	131	60	10
1120/22D	2000	260	165	70	10
1120/26D	4000	315	206	70	1
1120/29D	6000	355	236	80	1



 Sizes 1000ml and above have tooled rim for greater durability.





## Flasks, conical, narrow neck

**PYREX®**

- Complies with DIN ISO 1773
- Erlenmeyer pattern
- Manufactured from Pyrex® borosilicate glass for highest resistance to thermal shock and chemical corrosion
- White enamel graduations and marking spot
- Graduated to full capacity
- Printed with Trace Code for downloadable batch certificate
- Batch certificate available to download from [www.scilabware.com](http://www.scilabware.com)

Product Code	Capacity (ml)	Body O.D. (mm)	Height (mm)	Neck I.D. (mm)	Pack qty.
1130/03	5	25	52	12	10
1130/05M	10	30	60	12	10
1130/11M	25	42	70	18	10
1130/02M	50	51	85	18	10
1130/06D	100	64	105	18	10
1130/08D	125	69	117	28	10
1130/10D	150	74	118	28	10
1130/12D	200	79	131	34	10
1130/14D	250	85	145	34	10
1130/16D	300	87	156	34	10
1130/20D	500	105	180	34	10
1130/26D	1000	131	220	37	10
1130/30D	2000	166	280	50	10
1130/32D	3000	187	310	52	2
1130/36D	5000	220	365	52	1

**NEW**



5, 10, 125, 150, 200, 300 and 5000ml flasks are supplementary to the ISO range. 125ml flask conform to ASTM E1404 - 94.

## AZLON® SQUAT FORM MEASURING CYLINDERS

- Low height improves stability on lab bench
- Easier to manoeuvre in fume cupboards
- Robust polypropylene construction
- Unique drainage hole for problem-free washing

For full details see CPS: range on page 120



## Flasks, conical, narrow neck, heavy duty

PYREX®

- Mechanically stronger than standard flasks
- Designed for longer life and increased user safety
- Reinforced rims to reduce chipping and breakage

Product Code	Capacity (ml)	Height (mm)	Body O.D. (mm)	Neck I.D. (mm)	B.S. stopper size	Pack qty.
4980-10	10	50	31	10	10	12
4980-25	25	65	41	13	13	12
4980-50	50	78	51	14	14	12
4980-125	125	114	67	23	23	12
4980-250	250	132	82	27	27	12
4980-500	500	176	101	31	31	6
4980-1L	1000	216	129	37	37	6
4980-2L	2000	268	160	43	43	1
4980-4L	4000	360	206	43	43	1
4980-6L	6000	410	235	43	43	1



If using Pyrex® conical flasks to prepare culture media or to heat viscous solutions, remember to stir the solution regularly to dissipate the heat. Failure to observe this procedure can result in thermal breakage.



## Flasks, conical, wide neck

PYREX®

- Complies with DIN ISO 24450
- Erlenmeyer pattern
- Manufactured from Pyrex® borosilicate glass
- Excellent thermal performance
- High resistance to chemical attack
- White enamel graduations and marking spot
- Graduated to capacity
- Printed with Trace Code for downloadable batch certificate
- Batch certificate available to download from [www.scilabware.com](http://www.scilabware.com)

Product Code	Capacity (ml)	Body O.D. (mm)	Height (mm)	Neck I.D. (mm)	Pack qty.
1140/02M	50	48	85	30	10
1140/04D	100	64	110	30	10
1140/08D	250	85	140	46	10
1140/10D	500	105	175	46	10
1140/14D	1000	131	220	46	10
1140/18D	2000	153	275	66	10



2000ml size is supplementary to ISO range.



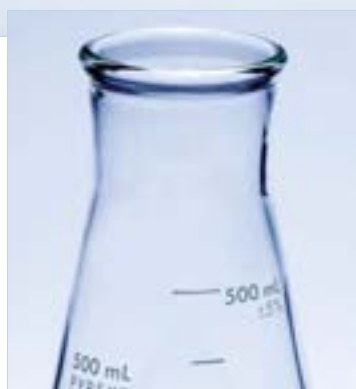

## Flasks, conical, wide neck, heavy duty

**PYREX®**

- Mechanically stronger than conventional Erlenmeyers
- Reinforced rims for extra strength and resistance to impact fracture
- Manufactured from high quality Pyrex® borosilicate glass
- White graduations and marking spot

Product Code	Capacity (ml)	Height (mm)	Body O.D. (mm)	Neck I.D. (mm)	B.S. stopper size	Pack qty.
5100-125	125	109	66	27	27	12
5100-250	250	133	78	33	33	12
5100-500	500	174	97	43	43	6
5100-1L	1000	220	122	52	48	6
5100-2L	2000	282	157	63	58	1



## Flasks, conical, screwcap

**PYREX®**

- Ideal for storage of culture specimens and media
- PBT screwcaps with PTFE faced sealing disc
- Erlenmeyer pattern
- Manufactured from Pyrex® borosilicate glass for highest resistance to thermal shock and chemical corrosion
- White enamel graduations and marking spot
- Graduated to full capacity

Product Code	Capacity (ml)	Body O.D. (mm)	Flask height (mm)	Cap size	Pack qty.
1137/11M	5	25	57	15	10
1137/12M	10	30	68	15	10
1137/13M	25	42	76	22	10
1137/02M	50	51	85	22	10
1137/03D	100	64	105	30	10
1137/06M	250	85	130	42	10
1137/08D	500	105	160	42	10
1137/10M	1000	131	210	42	1
1137/14M	2000	166	280	42	5
1137/18M	3000	187	315	42	5



Spare caps can be found on page 262.



If sterilising flasks by steam or dry heat, the screwcap must NOT be fully tightened. Slacken off first. Failure to follow this procedure can result in pressure build-up and possible fracture of the flask.

## Flasks, conical, graduated with ground socket

PYREX®

- Erlenmeyer flasks with high quality Quickfit® ground glass socket
- Manufactured from Pyrex® borosilicate glass for highest resistance to thermal shock and chemical corrosion
- White enamel graduations and marking spot

Product Code	Capacity (ml)	Socket size	Approx overall height (mm)	Approx diam. (mm)	Pack qty.
1132/02	50	19/26	85	50	10
1132/06	100	19/26	110	64	10
1132/14	250	24/29	130	85	10
1132/15	250	29/32	130	85	10
1132/20	500	29/32	170	105	10
1132/26	1000	29/32	210	130	10



These conical flasks are NOT suitable for use under vacuum.

## Flasks, conical, graduated, with stopper

PYREX®

- Erlenmeyer flasks with high quality Quickfit® ground glass socket
- Manufactured from Pyrex® borosilicate glass for highest resistance to thermal shock and chemical corrosion
- White enamel graduations and marking spot
- Supplied with hollow blown ground glass stopper

Product Code	Capacity (ml)	Socket size	Approx overall height (mm)	Approx diam. (mm)	Pack qty.
1133/02	50	19/26	85	51	10
1133/06	100	19/26	110	64	10
1133/14	250	29/32	130	85	10
1133/20	500	29/32	170	105	10
1133/26	1000	29/32	210	130	10



These flasks are NOT suitable for use under vacuum

## Flasks, conical, with ground socket



- Complies to ISO 4797
- Conical flasks with highest quality Quickfit® ground glass socket
- Borosilicate glass for corrosion-free performance and high resistance to thermal shock



Product Code	Nom. capacity (ml)	Socket size	Approx overall height (mm)	Approx diam. (mm)	Pack qty.
FE5/1	5	14/23	54	25	5
FE10/1	10	14/23	60	34	5
FE25/1	25	14/23	70	42	5
FE25/2	25	19/26	70	42	5
FE50/1	50	14/23	85	51	5
FE50/2	50	19/26	85	51	5
FE50/3	50	24/29	90	51	5
FE100/1	100	14/23	100	64	5
FE100/2	100	19/26	100	64	5
FE100/3	100	24/29	100	64	5
FE100/4	100	29/32	100	64	5
FE150/2	150	19/26	118	74	5
FE150/3	150	24/29	118	74	5
FE150/4	150	29/32	116	74	5
FE250/2	250	19/26	130	85	5
FE250/3	250	24/29	130	85	5
FE250/4	250	29/32	130	85	5
FE250/5	250	34/35	130	85	5
FE500/2	500	19/26	175	101	5
FE500/3	500	24/29	175	101	5
FE500/4	500	29/32	175	101	5
FE500/5	500	34/35	175	101	5
FE1L/3	1000	24/29	220	130	2
FE1L/4	1000	29/32	220	130	2
FE1L/5	1000	34/35	220	130	2
FE2L/4	2000	29/32	270	160	1
FE2L/5	2000	34/35	270	160	1



For Quickfit® glass stoppers please see pages 256-258. Flasks FE5 and FE150 are supplementary to ISO standard.



These conical flasks are NOT suitable for use under vacuum.

## Flasks, conical, vacuum



- With heavy walls and bases
- Suitable for use under vacuum

Product Code	Capacity (ml)	Socket size	Approx height (mm)	Approx diam. (mm)	Pack qty.
FEH250/3	250	24/29	139	90	1

 Always take safety precautions when using flasks under vacuum.



## Flask, conical, polypropylene



- Polypropylene Erlenmeyer flask with excellent chemical resistance
- Wide neck with PP screw cap or can be used with a stopper
- Flask and cap can be autoclaved at 121°C
- Suitable for food contact applications in accordance with EU regulations

Product Code	Capacity (ml)	Grads. (ml)	Thread size (mm)	Neck size	Pack qty.
FDE542	50	10	GL40	34/35	1
FDE544	100	20	GL40	34/35	1
FDE546	250	50	GL52	45/40	1
FDE548	500	100	GL52	45/40	1
FDE550	1000	200	GL52	45/40	1

 When autoclaving flasks, always ensure the caps are completely loosened or removed to prevent accidental implosion.



## Flask, conical, PMP



- Manufactured from transparent PMP
- Wide neck with PP screw cap or can be used with a stopper
- Flask and cap can be autoclaved at 121°C

Product Code	Capacity (ml)	Grads. (ml)	Thread size (mm)	Neck size	Pack qty.
FDE442	50	10	GL40	34/35	1
FDE444	100	20	GL40	34/35	1
FDE446	250	50	GL52	45/40	1
FDE448	500	100	GL52	45/40	1
FDE450	1000	200	GL52	45/40	1

 When autoclaving flasks, always ensure the caps are completely loosened or removed to prevent accidental implosion.

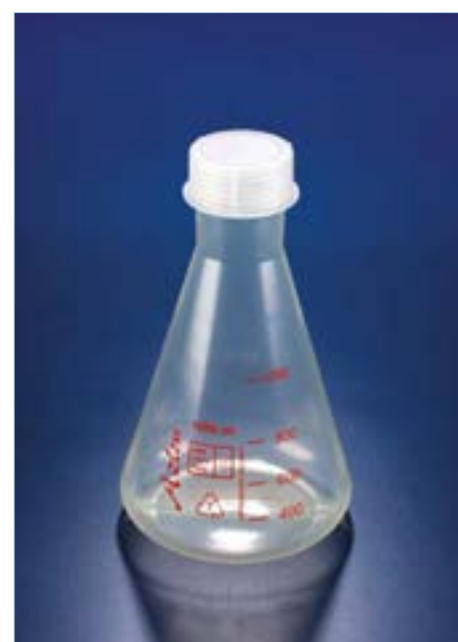



## Flasks, culture, baffled

**PYREX®**

- Ideal for use in preparation of cultures
- Manufactured from Pyrex® borosilicate glass
- Exhibits 4 baffle indents to provide optimal and consistent agitation
- Suitable for repeated autoclave cycles at 121°C

Product Code	Capacity (ml)	Body O.D. (mm)	Height (mm)	Neck I.D. (mm)	Pack qty.
1134/08	250	82	138	32	5
1134/10	500	101	186	36	5
1134/12	1000	129	222	43	2
1134/14	2000	161	282	49	1



**New**



## Flasks, culture, baffled, membrane screwcap

**PYREX®**

- Ideal for aerobic microbiology and cell culture
- Flasks complete with blue polypropylene GL45 screwcap with a gas-permeable PTFE membrane that permits gaseous exchange whilst contents remain sterile
- Flasks can be autoclaved with the membrane screwcap fastened
- Manufactured from Pyrex® borosilicate glass for maximum chemical and thermal resistance
- The four equidistant baffles provide consistent agitation when used with compatible orbital shakers
- Suitable for repeated autoclave cycles at 121°C

Product Code	Capacity (ml)	Body O.D. (mm)	Height (mm)	Thread size (mm)	Pack qty.
1142/08	250	82	130	45	5
1142/10	500	101	165	45	5
1142/12	1000	129	205	45	2
1142/14	2000	166	265	45	1

Spare membrane screwcaps 4507/45D, are available on page 52.



Always ensure that PTFE membrane is free from obstructions that may lead to pressure build up during an autoclave cycle.



## Flasks, culture, baffled, Delong neck

PYREX®

- Ideal for aerobic microbiology and cell culture
- Manufactured from Pyrex® borosilicate glass for maximum chemical and thermal resistance
- The four equidistant baffles provide consistent agitation when used with compatible orbital shakers
- Suitable for repeated autoclave cycles at 121°C
- Flasks are supplied without closures and should be ordered separately
- Compatible with either 4550/38M blue Aluminium and 4540/38P clear polypropylene closures

Product Code	Capacity (ml)	Body O.D. (mm)	Height (mm)	Neck O.D. (mm)	Pack qty.
1141/08	250	82	155	38	5
1141/10	500	101	193	38	5
1141/12	1000	128	222	38	2
1141/14	2000	166	300	38	1

 See page 144 for compatible aluminium and polypropylene closures.



## Flasks, culture, conical, Delong neck

PYREX®

- Ideal for use in preparation of cultures
- Compatible with shaker equipment
- Long, rimless tube neck for use with 4540/38P and 4550/38P closures
- Manufactured from Pyrex® borosilicate glass with white enamel markings
- Compatible with either Aluminium or polypropylene closures

Product Code	Capacity (ml)	Body O.D. (mm)	Height (mm)	Neck O.D. (mm)	Pack qty.
1135/14D	250	85	148	38	10
1135/20D	500	105	183	38	5
1135/26D	1000	131	229	38	2
1135/30D	2000	166	302	38	1

 See page 144 for compatible aluminium and polypropylene closures





## Flasks, culture, Fernbach

**PYREX®**

- For use in preparation of cultures
- Large surface area to volume ratio
- Manufactured from Pyrex® borosilicate glass
- Exhibit 3 baffle indents to provide optimal and consistent agitation
- Available in two versions
  - Delong neck, with 38mm neck O.D. for use with 4540/38P and 4550/38M closures
  - Screwcap, supplied with Polypropylene GL45 screwcap
- Screwcap version is compatible with membrane screwcap, available separately

Product Code	Description	Capacity (ml)	Height (mm)	Body O.D. (mm)	Pack qty.
1138/10	Delong neck	2800	230	210	2
1139/10	Screwcap	2800	230	210	2

## Culture flask closures

- For use with 1135 culture flasks, 1138/10 Fernbach flasks and 1141 baffled flasks
- Two types of closure
  - Anodised aluminium
  - 2-position polypropylene
- Both closures are suitable for autoclaving

Product Code	Description	Cap I.D. (mm)	Pack qty.
4550/38M	Aluminium	38	10
4540/38P	Polypropylene	38	10

## Flasks, culture, cylindrical

**PYREX®**

- Manufactured from Pyrex® borosilicate glass for the highest resistance to thermal shock and chemical corrosion
- Ideal for fermentation and culture work
- White enamel marking spot
- Autoclavable

Product Code	Capacity (ml)	Body O.D. (mm)	Neck I.D. (mm)	Height (mm)	Pack qty.
1190/02M	60	45	25	70	10
1190/04M	125	60	30	97	10
1190/06M	250	69	34	130	10
S/3L5895	500	90	35	154	5



## Flasks, distillation, ASTM

- Complies with ASTM E133 and E1405
- For the distillation of petroleum products
- 1290/04M complies with the requirements for ASTM test methods D86, D233, D447, D801, D802 and IP 123
- 1290/06M complies with the requirements for ASTM test method D447
- Side arm inclined at 75° to the vertical axis
- For use with thermometers calibrated for 76mm immersion
- Length of side-arm is 100mm

Product Code	Capacity (ml)	Bulb diam. (mm)	Neck I.D. (mm)	Sidearm O.D. (mm)	Height (mm)	Pack qty.
1290/04M	125	69	17	7	214	5
1290/06M	250	86	15	6	215	5



PYREX®

## Flasks, distillation

- For general distillation work
- Side-arm is inclined at 75° to the vertical axis
- For use with thermometers calibrated for 76mm immersion
- Side-arm length is 140mm

Product Code	Capacity (ml)	Bulb diam. (mm)	Neck I.D. (mm)	Sidearm O.D. (mm)	Height (mm)	Pack qty.
1280/14M	500	105	24	10	240	5



PYREX®

## Flasks, Büchner, plain side-arm

- Complies with ISO 6556
- Büchner type flasks for vacuum filtration
- Heavy walls provide increased mechanical strength
- 'Studded' base to minimise surface abrasion
- With integral glass side-arm to accept 9mm bore flexible tubing

Product Code	Nom. capacity (ml)	Body diam. (mm)	Neck I.D. (mm)	Height (mm)	Pack qty.
1170/02M	100	64	24	105	10
1170/04M	250	85	35	155	10
1170/06M	500	105	35	185	10
1170/08M	1000	135	45	230	5
1170/10D	2000	166	60	260	1
1170/12M	3000	187	68	335	5
1170/14D	5000	220	68	385	1

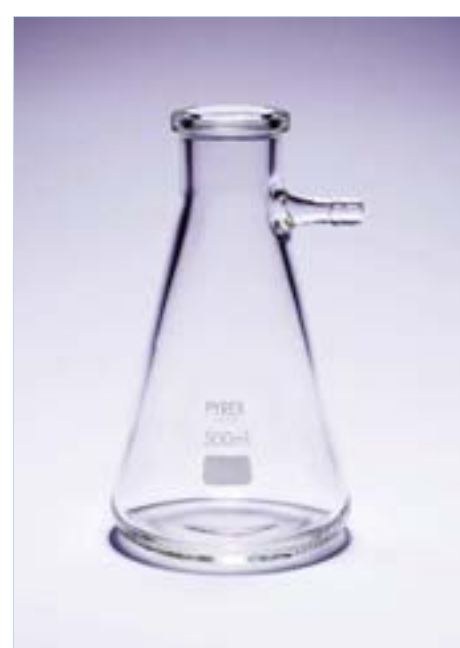

PYREX®



3000 and 5000ml flasks are supplementary to ISO range.



## Flasks, Büchner, with screwthread connector

**PYREX®**

- Complies with ISO 6556 and DIN 12476
- Büchner flasks with heavy wall construction for vacuum filtration applications
- Side-arm features a PTFE screwthread connector for easy and safe fitting of 9mm bore vacuum tubing
- With tooled neck to accept a drilled rubber stopper

Product Code	Capacity (ml)	Body diam. (mm)	Neck I.D. (mm)	Height (mm)	Pack qty.
1170/02SC	100	64	24	105	10
1170/04SC	250	85	35	155	10
1170/06SC	500	105	35	185	10
1170/08SC	1000	135	45	230	5
1170/10SC	2000	166	60	260	1
1170/14SC	5000	220	68	385	1



5000ml size is supplementary to ISO range. For spare PTFE screwthread connectors, please see page 104.



## Flasks, Büchner, plain side-arm and ground socket



- Complies with ISO 6556
- Büchner filter flasks with precision-ground Quickfit® socket
- With traditional plain glass side-arm to accept 9mm bore vacuum tubing
- Heavy-wall and base construction for vacuum work

Product Code	Nom. capacity (ml)	Socket size	Approx height (mm)	Approx diam. (mm)	Pack qty.
FB100/2	100	19/26	107	64	2
FB100/3	100	24/29	107	64	2
FB250/3	250	24/29	145	85	2
FB250/4	250	29/32	145	85	2
FB500/3	500	24/29	172	105	2
FB500/4	500	29/32	172	105	2
FB1L/3	1000	24/29	227	136	2
FB1L/4	1000	29/32	227	136	2

## Flasks, Büchner, with screwthread connector and ground socket



- Complies with ISO 6556
- Büchner flasks with precision-ground Quickfit® socket
- Side-arm features a PTFE screwthread connector for the safe attachment of 9mm bore vacuum tubing
  - Unscrew connector from flask and fit tubing:
  - Rescrew connector and tubing to flask
- Heavy walls and bases for vacuum filtration work

Product Code	Nom. capacity (ml)	Socket size	Approx height (mm)	Approx diam. (mm)	Pack qty.
FB100/2SC	100	19/26	107	64	2
FB100/3SC	100	24/29	107	64	2
FB250/3SC	250	24/29	145	85	2
FB250/4SC	250	29/32	145	85	2
FB500/3SC	500	24/29	172	105	2
FB500/4SC	500	29/32	172	105	2
FB1L/3SC	1000	24/29	227	136	2
FB1L/4SC	1000	29/32	227	136	2



## Flasks, Iodine



- Complies with BS 2735
- For the determination of iodine
- Flask has ground socket and cup shaped top
- Stopper has extended handle which projects well above the liquid seal
- Stopper available separately

Product Code	Nom. capacity (ml)	Joint size	Min. cup capacity (ml)	Pack qty.
FIB250/3	250	24/29	20	2
FIB250/4	250	29/32	20	2
FIB500/3	500	24/29	20	2
FIB500/4	500	29/32	20	2

 FIB/4 items are supplementary to BS 2735.



## Flasks, Iodine stopper



Product Code	Joint size	Pack qty.
SIB24	24/29	2
SIB29	29/32	2



## Flasks, Kjeldahl with plain neck

**PYREX®**

- Suitable for the determination of nitrogen etc.
- Manufactured from Pyrex® borosilicate glass
  - Withstands high temperatures
  - Resistant to chemical corrosion

Product Code	Capacity (ml)	Bulb diam. (mm)	Height (mm)	Neck O.D. (mm)	Neck I.D. (mm)	Pack qty.
1200/04M	100	58	240	22	17	10
1200/10D	300	81	300	28	24	10
1200/12D	500	101	325	34	30	10
1200/16M	800	115	350	34	30	10

**i** The Kjeldahl method subjects flasks to severe chemical and thermal abuse. See care and maintenance of laboratory glassware for advice on safety and usage.



## Flasks, Kjeldahl with ground socket



- For the determination of nitrogen by the Kjeldahl method
- Extra long necks act as air condensers during digestion stage and reduce entrainment during distillation stage

Product Code	Nom. capacity (ml)	Approx overall height (mm)	Socket size	Pack qty.
FK300/3L	300	295	24/29	1
FK500/3L	500	305	24/29	1
FK800/3L	800	325	24/29	1

**i** A Quickfit® assembly for Kjeldahl digestions and distillations is described on page 208.

**!** The Kjeldahl method of nitrogen determination imposes severe demands on glassware.

## Flasks, flat bottom, short neck



- Complies with ISO 1773 and ISO 4797
- With highest quality Quickfit® ground glass socket
- Borosilicate glass for highest resistance to thermal shock and chemical corrosion
- Flat base allows use with hotplates

Product Code	Nom. capacity (ml)	Socket size	Approx overall height (mm)	Approx neck length (mm)	Pack qty.
FF50/2S	50	19/26	85	10	5
FF50/3S	50	24/29	85	10	5
FF100/2S	100	19/26	95	10	5
FF100/3S	100	24/29	103	15	5
FF100/4S	100	29/32	103	15	5
FF100/5S	100	34/35	103	15	5
FF150/2S	150	19/26	105	10	5
FF150/3S	150	24/29	110	15	5
FF150/4S	150	29/32	110	10	5
FF150/5S	150	34/35	115	10	5
FF250/2S	250	19/26	130	10	5
FF250/3S	250	24/29	130	10	5
FF250/4S	250	29/32	130	10	5
FF250/5S	250	34/35	130	10	5
FF500/2S	500	19/26	135	15	5
FF500/3S	500	24/29	140	15	5
FF500/4S	500	29/32	145	15	5
FF500/5S	500	34/35	155	20	5
FF1L/3US	1000	24/29	170	25	2
FF1L/4S	1000	29/32	187	20	2
FF1L/5S	1000	34/35	175	20	2
FF2L/3S	2000	24/29	205	25	1
FF2L/4S	2000	29/32	230	25	1
FF2L/5S	2000	34/35	215	20	1
FF4L/7S	4000	45/40	260	20	1



FF150/3S, FF150/4S, FF150/5S and FF500/2S are supplementary to ISO 4797.

These flat bottom flasks are NOT suitable for use under vacuum.

## Flasks, flat bottom, medium neck



- With longer neck than standard Quickfit® flasks
- Useful in reducing the problems associated with splashing and frothing

Product Code	Capacity (ml)	Socket size	Approx overall height (mm)	Approx neck length (mm)	Pack qty.
FF100/3M	100	24/29	130	45	2
FF150/3M	150	24/29	140	45	2
FF250/3M	250	24/29	150	45	2
FF500/3UM	500	24/29	170	45	2
FF1L/3M	1000	24/29	190	45	2



*These flat bottom flasks are NOT suitable for use under vacuum.*



## Flasks, Florentine



- Ideal for use with rotary evaporators
- Large surface area for rapid evaporation
- Robust heavy wall construction for added strength
- Shape allows easy removal of solid residues

Product Code	Nom. capacity (ml)	Socket size	Approx overall height (mm)	Pack qty.
FD50/4RE	50	29/32	94	2
FD100/3	100	24/29	108	1
FD100/4RE	100	29/32	107	1
FD250/3	250	24/29	148	1
FD250/4RE	250	29/32	151	1
FD500/3	500	24/29	165	1
FD500/4RE	500	29/32	160	1
FD1L/3	1000	24/29	204	1
FD1L/4RE	1000	29/32	198	1
FD2L/4RE	2000	29/32	245	1



*Most Rotary Evaporators accept flasks with size 29/32 ground glass sockets - check first.*



## Flasks, pear shaped, single neck



- With highest quality Quickfit® ground glass socket
- Ideal for semi-micro distillations
- Pear shaped design allows distillation down to small quantities:
  - Minimum hold-up
  - Reduced losses from thermal decomposition
- Borosilicate glass for chemical resistance and thermal performance

Product Code	Capacity (ml)	Socket size	Approx overall height (mm)	Approx diam. (mm)	Pack qty.
FP5/1	5	14/23	67	23	1
FP10/1	10	14/23	85	28	1
FP25/0	25	10/19	89	38	1
FP25/1	25	14/23	100	38	1
FP50/1	50	14/23	115	48	1
FP50/2	50	19/26	125	48	1
FP100/1	100	14/23	135	58	1
FP100/2	100	19/26	140	58	1
FP100/3	100	24/29	150	58	1



For advice on the use of glassware under conditions of temperature and vacuum, please refer to the care and maintenance section.

## Flask, pear shaped, two necks



- With one vertical centre neck and one angled side neck

Product Code	Capacity (ml)	Centre socket	Side socket size	Approx overall height (mm)	Pack qty.
FP50/1/1A	50	14/23	14/23	115	1



The axis of the side neck meets the axis of the central neck at the bottom of the flask.







## Flask, pear shaped, three necks



- With vertical centre neck
- One vertical side neck and one angled side neck

Product Code	Nom. capacity (ml)	Centre socket	Side socket size	Approx overall height (mm)	Pack qty.
FP25/0AP	25	10/19	10/19	112	1



## Flask, pear shaped, distillation



- Designed for micro and semi-micro distillations
- Vertical neck with Quickfit® socket for introducing a thermometer etc.
- Angled Quickfit® cone for connecting to condenser

Product Code	Capacity (ml)	Socket size	Cone size	Approx overall height (mm)	Pack qty.
MD2/50	50	14/23	14/23	147	1

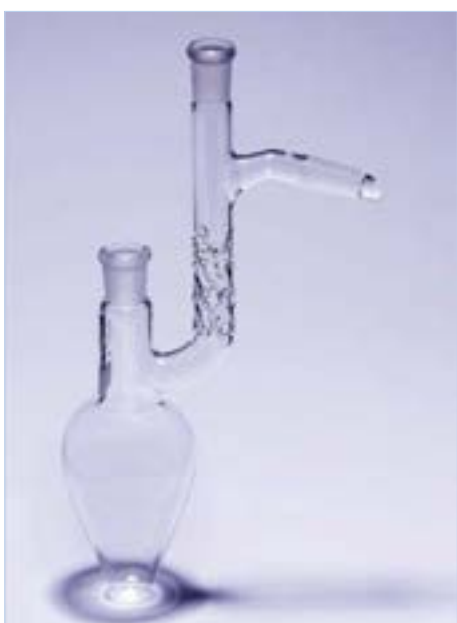

## Flask, pear shaped, Claisen-Vigreux



- Incorporates a short, Vigreux type fractionating column
- Column indents aid intimate contact between vapour and liquid

Product Code	Capacity (ml)	Socket size	Cone size	Pack qty.
MD4/50	50	14/23	14/23	1
MD4/100	100	14/23	14/23	1



Quality  
for over  
80 years



Back in 1934 we pioneered the concept of interchangeable jointed glassware, changing forever how experiments are performed in laboratories around the world.

For over 80 years, Quickfit® has been setting standards of excellence for others to follow.

Today more than 1000 products carry the famous Quickfit® badge, from adapters and condensers to funnels and flasks, presenting the world's widest choice of jointed assemblies.

Manufactured exclusively from Pyrex® borosilicate glass to a specification tighter than those defined by British and international standards, Quickfit® is your guarantee of a leak-free performance and smooth interchangeability, ...every time.

To find out more about the best jointed glassware money can buy, call today for a catalogue or visit our website.

## Flasks, round bottom, short neck



- With highest quality Quickfit® ground glass socket
- Manufactured from borosilicate glass for corrosion-free performance and resistance to thermal shock
- Comprehensive range of 45 flasks from 5ml to 10000ml
- Body diameter and wall thickness comply with relevant ISO 1773 and ISO 4797 requirements



Product Code	Capacity (ml)	Socket size	Approx overall height (mm)	Approx neck length (mm)	Pack qty.
FR5/0S*	5	10/19	50	5	5
FR5/1S*	5	14/23	65	15	5
FR10/0S*	10	10/19	65	15	5
FR10/1S	10	14/23	70	15	5
FR25/1S	25	14/23	85	10	5
FR25/2S*	25	19/26	80	15	5
FR25/3S*	25	24/29	80	15	5
FR50/1S	50	14/23	90	15	5
FR50/2S	50	19/26	90	15	5
FR50/3S	50	24/29	90	15	5
FR50/5S	50	34/35	90	15	5
FR100/1S	100	14/23	105	15	5
FR100/2S	100	19/26	105	15	5
FR100/3S	100	24/29	105	15	5
FR100/4S	100	29/32	105	15	5
FR100/5S	100	34/35	105	10	5
FR150/2S*	150	19/26	114	10	5
FR150/3S*	150	24/29	115	15	5
FR150/4S*	150	29/32	120	15	5
FR150/5S*	150	34/35	118	10	5
FR250/1S*	250	14/23	126	15	2
FR250/2S	250	19/26	140	15	5
FR250/3S	250	24/29	140	15	5
FR250/4S	250	29/32	140	15	5
FR250/5S	250	34/35	140	15	5

## Flasks, round bottom, short neck, continued

Product Code	Capacity (ml)	Socket size	Approx overall height (mm)	Approx neck length (mm)	Pack qty.
FR500/2S	500	19/26	147	15	5
FR500/3S	500	24/29	163	15	5
FR500/4S	500	29/32	163	15	5
FR500/5S	500	34/35	163	25	5
FR1L/2S	1000	19/26	177	15	2
FR1L/3S	1000	24/29	180	15	2
FR1L/4S	1000	29/32	183	10	2
FR1L/5S	1000	34/35	196	20	2
FR1L/7S	1000	45/40	201	25	1
FR2L/3US	2000	24/29	205	10	1
FR2L/3S	2000	24/29	240	20	1
FR2L/4S	2000	29/32	240	15	1
FR2L/5S	2000	34/35	228	20	1
FR3L/3S*	3000	24/29	236	15	1
FR3L/5S*	3000	34/35	249	20	1
FR4L/7S	4000	45/40	270	20	1
FR5L/4S	5000	29/32	276	15	1
FR5L/5US	5000	34/35	280	20	1
FR6L/7S	6000	45/40	300	20	1
FR10L/5S	10000	34/35	350	20	1

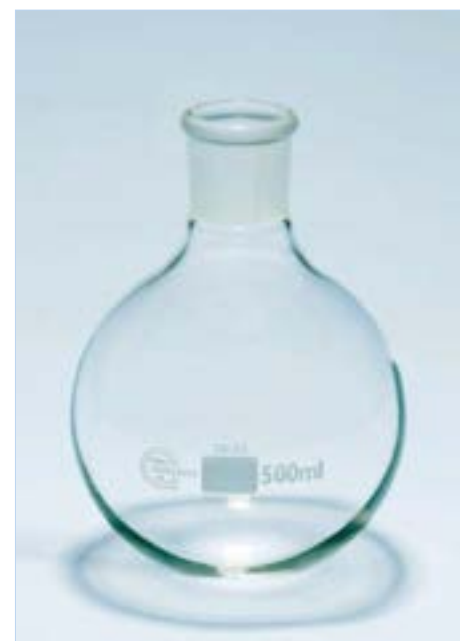

 \* is supplementary to the ISO 4797 range.

## Flask stand, polypropylene

*A E Azlon*

- Suitable for most round bottomed flasks
- Has stepped concentric rings to help stabilise flask
- Autoclavable up to 121°C
- Has good chemical resistance

Product Code	Top I.D. (mm)	Pack qty.
TWR038	145	1





## Flasks, round bottom, medium neck



- With a longer neck than standard Quickfit® flasks
- Useful for reducing problems associated with frothing and splashing

Product Code	Capacity (ml)	Socket size	Approx overall height (mm)	Approx neck length (mm)	Pack qty.
FR50/3M	50	24/29	130	45	5
FR100/3M	100	24/29	145	45	2
FR150/3M	150	24/29	150	45	2
FR250/3M	250	24/29	165	45	2
FR500/3M	500	24/29	180	45	2
FR500/3U	500	24/29	205	70	1
FR1L/3UM	1000	24/29	205	40	2



## Flasks, round bottom, two necks



- Fitted with two Quickfit® ground glass sockets
  - One vertical centre neck
  - One angled side neck
- Side neck useful for introducing gas inlet tubes and thermometers etc into the flask
- Manufactured from borosilicate glass for highest resistance to thermal shock and chemical attack

Product Code	Capacity (ml)	Centre socket	Side socket size	Approx overall height (mm)	Pack qty.
FR25/1S/1A	25	14/23	14/23	77	1
FR50/1S/1A	50	14/23	14/23	89	1
FR100/3S/1A	100	24/29	14/23	110	1
FR100/3S/2A	100	24/29	19/26	110	1
FR250/3S/1A	250	24/29	14/23	130	1
FR250/3S/2A	250	24/29	19/26	130	1
FR500/3S/1A	500	24/29	14/23	150	1
FR500/3S/2A	500	24/29	19/26	150	1
FR1L/3S/1A	1000	24/29	14/23	180	1
FR1L/3S/2A	1000	24/29	19/26	180	1
FR2L/5S/2A	2000	34/35	19/26	225	1



The axis of the side neck meets the axis of the centre neck at the bottom of the flask.

## Flasks, small capacity, with septum side neck



- Designed for semi-micro and micro scale preparations
- One vertical centre neck having precision-ground Quickfit® socket to accept Quickfit® cone
- One angled side neck designed to take a rubber septum seal to allow small quantities of liquid to be handled easily and safely using a syringe

Product Code	Capacity (ml)	Centre socket	Side socket size	Approx overall height (mm)	Pack qty.
FR10/1S/SEP	10	14/23	Septum	60	1
FR25/1S/SEP	25	14/23	Septum	77	1

 Septum side necks have an O.D. of 19mm and an I.D. of 15.4mm to accept a 16mm septum.



## Flasks, round bottom, three necks



- Fitted with three Quickfit® precision-ground sockets
  - One vertical centre neck
  - Two angled side necks
- Quickfit® ground glass sockets are manufactured to an accuracy which surpasses the requirements of ISO 383

Product Code	Nom. capacity (ml)	Centre socket	Side sockets	Approx overall height (mm)	Pack qty.
FR25/1S/11A	25	14/23	14/23	77	1
FR25/2S/11A	25	19/26	14/23	80	1
FR50/1S/11A	50	14/23	14/23	89	1
FR50/2S/11A	50	19/26	14/23	92	1
FR50/2S/22A	50	19/26	19/26	92	1
FR100/2S/11A	100	19/26	14/23	108	1
FR100/3S/11A	100	24/29	14/23	110	1
FR100/3S/22A	100	24/29	19/26	110	1
FR250/2S/22A	250	19/26	19/26	128	1
FR250/3S/11A	250	24/29	14/23	130	1
FR250/3S/22A	250	24/29	19/26	130	1
FR250/4S/11A*	250	29/32	14/23	135	1
FR250/4S/22A*	250	29/32	19/26	135	1
FR500/3S/11A	500	24/29	14/23	150	1
FR500/3S/22A	500	24/29	19/26	150	1
FR500/4S/22A*	500	29/32	19/26	153	1
FR1L/3S/22A	1000	24/29	19/26	180	1
FR1L/4S/22A*	1000	29/32	19/26	183	1
FR1L/4S/44A	1000	29/32	29/32	183	1
FR1L/5S/22A	1000	34/35	19/26	195	1
FR2L/3US/22A	2000	24/29	19/26	205	1
FR2L/5S/22A	2000	34/35	19/26	228	1
FR3L/5S/22A	3000	34/35	19/26	249	1



 The axes of the side necks meet the axis of the central neck at the bottom of the flask.  
\* complies with DIN 12394



 \* Complies with DIN 12392.

## Flasks, round bottom, three vertical necks



- With one vertical centre neck and two vertical side necks

Product Code	Capacity (ml)	Centre socket	Side sockets	Approx overall height (mm)	Pack qty.
FR250/3S/22P	250	24/29	19/26	130	1
FR250/4S/11P	250	29/32	14/23	135	1
FR500/3S/22P	500	24/29	19/26	150	1
FR500/4S/22P	500	29/32	19/26	153	1
FR1L/3S/22P	1000	24/29	19/26	180	1
FR1L/4S/22P	1000	29/32	19/26	185	1
FR1L/5S/22P	1000	34/35	19/26	195	1
FR1L/5S/33P	1000	34/35	24/29	195	1
FR2L/3US/22P	2000	24/29	19/26	210	1
FR2L/4S/22P	2000	29/32	19/26	220	1
FR2L/4S/44P*	2000	29/32	29/32	218	1
FR2L/5S/22P	2000	34/35	19/26	228	1
FR2L/5S/33P	2000	34/35	24/29	228	1
FR2L/7S/44P*	2000	45/40	29/32	233	1
FR3L/5S/22P	3000	34/35	19/26	249	1
FR3L/5S/33P	3000	34/35	24/29	249	1
FR4L/7S/44P*	4000	45/40	29/32	270	1
FR5L/5US/33P	5000	34/35	24/29	275	1
FR6L/7S/44P*	6000	45/40	29/32	300	1



## Flasks, Roux culture, off-set neck

**PYREX®**

- Ideal for cell culture
- Manufactured from chemically inert Pyrex® glass for a contamination-free environment
- Withstands repeated autoclaving
- Off-set neck

Product Code	Capacity (ml)	Base x height (mm)	Neck I.D. (mm)	Length (mm)	Pack qty.
1350/04M	600	107 x 47	28	230	10
1350/06M	1200	123 x 56	33	275	10

## Flasks, reaction, wide neck, flat flange



- With large diameter Quickfit® flat-flange joint
- For use with Quickfit® flat-flange lids and retaining clips
- Wide neck allows easy incorporation of stirrer paddles and easy removal of solid residues

Product Code	Item code: clip to fit	Nom. capacity (ml)	Flange bore (mm)	Flask shape	Body O.D. (mm)	Approx overall height (mm)	Pack qty.
FR250F	JC75F	250	75	Spherical	85	90	1
FR500F	JC75F	500	75	Spherical	105	115	1
FR700F	JC100F	700	100	Cylindrical	103	135	1
FR1LF	JC100F	1000	100	Spherical	131	155	1
FR2LF	JC100F	2000	100	Spherical	166	185	1
FR3LF	JC100F	3000	100	Spherical	189	210	1
FR4LF	JC100F	4000	100	Spherical	207	225	1
FR5LF	JC100F	5000	100	Spherical	222	245	1
FR6LF	JC100F	6000	100	Spherical	236	260	1
FR10LF	JC100F	10000	100	Spherical	279	320	1
FR20LF	JC100F	20000	100	Spherical	345	380	1



 The cylindrical shaped 700ml flask fits a 500ml heating mantle. See pages 160 and 161 for a comprehensive range of flat flange lids and retaining clips.

## Flasks, reaction, jacketed



- With outer jacket for circulation of water or oil etc
- Ideal for temperature controlled reactions
- For use with Quickfit® flat-flange lids and retaining clips

Product Code	Nom. capacity (ml)	Flange bore (mm)	Overall height (mm)	Body O.D. (mm)	Sidearm O.D. (mm)	Pack qty.
JRV1L	1000	100	228	140	12	1
JRV2L	2000	100	312	165	12	1

 When circulating hot water or oil through the jacket, take care to avoid thermal shock. Raise the temperature gradually and do not exceed 300°C.







## Culture vessels



- Ideal for fermentation and culture work
- Manufactured from temperature resistant borosilicate glass
- Autoclavable
- With precision-ground flat-flange joint
- For use with Quickfit® flat-flange lids and retaining clips

Product Code	Capacity (ml)	Flange bore (mm)	Approx overall height (mm)	Approx diam. of body (mm)	Pack qty.
FV500	500	75	130	80	1
FV1L	1000	100	160	105	1
FV2L	2000	100	225	133	1
FV5L	5000	100	290	181	1
FV10L	10000	100	375	227	1
FV20L	20000	100	465	288	1



Culture vessels with flat bases are not suitable for use under vacuum.



## Lids for wide neck flasks



- With precision ground flat-flange joints
- Fits Quickfit® wide neck reaction flasks and culture vessels
- Each lid with one or more sockets to accept other Quickfit® components

Product Code	Flange bore (mm)	Vertical centre socket	Side socket (0°)	Side socket (5°)	Side socket (10°)	Side socket (15°)	Pack qty.
MAF1/75	75	19/26	14/23	19/26	19/26	19/26	1
DA5/75	75	34/35	-	-	-	-	1
MAF2/2	100	19/26	19/26	2 x 19/26	19/26	-	1
MAF2/32	100	19/26	19/26	24/29	19/26	-	1
MAF2/41	100	19/26	14/23	14/23	14/23	29/32	1
MAF2/52	100	19/26	19/26	19/26	19/26	34/35	1
MAF3/52	100	24/29	19/26	19/26	19/26	34/35	1
DA4/100	100	29/32	-	-	-	-	1
MAF4/41	100	29/32	14/23	14/23	14/23	29/32	1
DA5/100	100	34/35	-	-	-	-	1
MAF5/2	100	34/35	19/26	-	2 x 19/26	-	1



Lids should be secured to flasks with relevant metal clips, JC75F or JC100F as detailed overleaf.

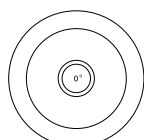

DA4/100  
DA5/75  
DA5/100

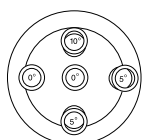

MAF2/2

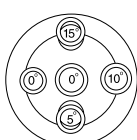

MAF1/75

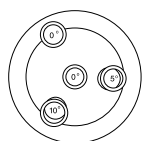

MAF2/32

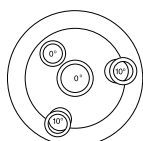

MAF5/2

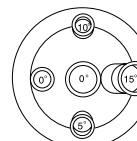

MAF2/41  
MAF2/52  
MAF3/52  
MAF4/41

## Retaining clips for wide neck flask lids



- For securing flat flange lids to wide neck reaction flasks and culture vessels
- Stainless steel construction

Product Code	Flange bore (mm)	Pack qty.
JC75F	75	1
JC100F	100	1



## PTFE Seals



- For use with Quickfit® flat flange jointed glassware
- Manufactured from PTFE for excellent chemical resistance
- Forms tight seal with flat flange joints

Product Code	Flange bore (mm)	Thickness (mm)	Pack qty.
PS75	75	0.5	1
PS100	100	0.5	1



## Flasks, volumetric, class A, works certified, USP/ISO/DIN tolerances

**PYREX®**

- Complies with ISO 1042 and DIN 12664
- Calibrated to the tolerances required by the United States Pharmacopoeia (USP) which are tighter than those of ISO/DIN standards
- Each flask engraved with individual serial number and supplied with certificate of calibration traceable to National standards
- Conformity 'H' certified
- Manufactured from borosilicate glass for corrosion-free performance
- White enamel inscriptions
- Polyethylene stopper

Product Code	Capacity (ml)	Tol. (+/- ml)	Approx height (mm)	Stopper size	Pack qty.
3151/01WC	1	0.020	65	7/16	5
3151/02WC	2	0.020	65	7/16	5
3151/04WC	5	0.020	70	10/19	5
3151/06WC	10	0.020	90	10/19	5
3151/08WC	20	0.03	110	10/19	5
3151/10WC	25	0.03	110	10/19	5
3151/12WC	50	0.05	140	12/21	5
3151/14WC	100	0.08	170	14/23	5
3151/16WC	200	0.10	210	14/23	5
3151/18WC	250	0.12	220	14/23	2
3151/20WC	500	0.20	260	19/26	2
3151/22WC	1000	0.30	300	24/29	2
3151/24WC	2000	0.50	370	29/32	1
3151/26WC	5000	1.00	475	34/35	1

 20ml and 5000ml sizes are supplementary to DIN range.



**Flasks, volumetric, class A, amber, works certified, PYREX®  
USP/ISO/DIN tolerances**

- Complies with ISO 1042 and DIN 12664
- Calibrated to the tolerances required by the United States Pharmacopoeia (USP) which are tighter than those of ISO/DIN standards
- Each flask engraved with individual serial number and supplied with certificate of calibration traceable to National standards
- Manufactured from borosilicate glass with an amber coating on exterior surfaces to facilitate use with light sensitive solutions
- Conformity 'H' certified
- Polyethylene stopper
- White enamel inscriptions

Product Code	Capacity (ml)	Tol. (+/- ml)	Approx height (mm)	Stopper size	Pack qty.
3152/04AWC	5	0.020	70	10/19	5
3152/06AWC	10	0.020	90	10/19	5
3152/08AWC	25	0.03	110	10/19	5
3152/10AWC	50	0.05	140	12/21	5
3152/12AWC	100	0.08	170	14/23	5
3152/14AWC	200	0.10	210	14/23	5
3152/16AWC	250	0.12	220	14/23	2
3152/18AWC	500	0.20	260	19/26	2
3152/20AWC	1000	0.30	300	24/29	2
3152/22AWC	2000	0.50	370	29/32	1



 For spare polyethylene stoppers, please see page 258.

## Flasks, volumetric, class A, USP/ISO/DIN tolerances **PYREX®**

- Complies with ISO 1042 and DIN 12664
- Calibrated to the tolerance required by the United States Pharmacopoeia (USP) which is tighter than those of ISO/DIN standards
- Each flask is laser etched with an individual serial number, batch code and date of manufacture
- Batch certificate available to download online
- Conformity 'H', certified
- Manufactured from chemically resistant Pyrex® glass
- Inscriptions in white enamel
- Polyethylene stopper

Product Code	Capacity (ml)	Tol. (+/- ml)	Approx height (mm)	Stopper size	Pack qty.
3151/01	1	0.020	65	7/16	5
3151/02	2	0.020	65	7/16	5
3151/04	5	0.020	70	10/19	5
3151/06	10	0.020	90	10/19	5
3151/08	20	0.03	110	10/19	5
3151/10	25	0.03	110	10/19	5
3151/12	50	0.05	140	12/21	5
3151/14	100	0.08	170	14/23	5
3151/16	200	0.10	210	14/23	5
3151/18	250	0.12	220	14/23	2
3151/20	500	0.20	260	19/26	2
3151/22	1000	0.30	300	24/29	2
3151/24	2000	0.50	370	29/32	1
3151/26	5000	1.00	475	34/35	1

**i** 20ml and 5000ml sizes are supplementary to DIN range. Please note that the downloadable batch certificates can be obtained by visiting [www.scilabware.com](http://www.scilabware.com) and entering the unique batch code, which can be found on the base of each flask. UKAS certified volumetric flasks are available on request.

## Flasks, volumetric, class A, amber, USP/ISO/DIN tolerances

PYREX®

- Complies with ISO 1042 and DIN 12664
- Calibrated to the tolerance required by the United States Pharmacopoeia (USP) which are tighter than those of ISO/DIN standards
- Manufactured from borosilicate glass with an amber coating on exterior surfaces to facilitate use with light sensitive solutions
- Each flask is laser etched with an individual serial number, batch code and date of manufacture
- Conformity 'H' certified
- Batch certificate available to download online

Product Code	Capacity (ml)	Tol. (+/- ml)	Approx height (mm)	Stopper size	Pack qty.
3152/04A	5	0.020	70	10/19	5
3152/06A	10	0.020	90	10/19	5
3152/08A	25	0.03	110	10/19	5
3152/10A	50	0.05	140	12/21	5
3152/12A	100	0.08	170	14/23	5
3152/14A	200	0.10	210	14/23	5
3152/16A	250	0.12	220	14/23	2
3152/18A	500	0.20	260	19/26	2
3152/20A	1000	0.30	300	24/29	2
3152/22A	2000	0.50	370	29/32	1



 UKAS certified volumetric flasks are available on request.

## Flasks, volumetric, class A

**MBL<sup>®</sup>**

- Complies with ISO 1042 and DIN 12664
- Finely calibrated to Class A tolerances
- Each flask is laser etched with an individual serial number, batch code and date of manufacture
- Manufactured from chemically resistant borosilicate glass
- Conformity 'H' certified
- Inscriptions in blue enamel
- Supplied with polyethylene stopper
- Batch certificate available to download online



Product Code	Capacity (ml)	Tol. (+/- ml)	Approx height (mm)	Stopper size	Pack qty.
FRD164	5	0.025	70	10/19	5
FRD166	10	0.025	90	10/19	5
FRD167	20	0.04	110	10/19	5
FRD168	25	0.04	110	10/19	5
FRD170	50	0.06	140	12/21	5
FRD172	100	0.10	170	14/23	5
FRD174	200	0.15	210	14/23	5
FRD176	250	0.15	220	14/23	2
FRD178	500	0.25	260	19/26	2
FRD180	1000	0.40	300	24/29	2
FRD182	2000	0.60	370	29/32	1
FRD184	5000	1.20	475	34/35	1



The downloadable batch certificates can be obtained by visiting [www.scilabware.com](http://www.scilabware.com) and entering the unique batch code, which can be found on the base of each flask.

## Flasks, volumetric, class B



**MBL®**

- Complies with ISO 1042 and DIN 12664
- Manufactured from borosilicate glass for corrosion-free performance
- Inscriptions in blue enamel
- Polyethylene stopper

Product Code	Capacity (ml)	Tol. (+/- ml)	Approx height (mm)	Stopper size	Pack qty.
FRD022P	5	0.05	70	10/19	5
FRD024P	10	0.05	90	10/19	5
FRD025P	20	0.08	110	10/19	5
FRD026P	25	0.08	110	10/19	5
FRD028P	50	0.12	140	12/21	5
FRD030P	100	0.20	170	14/23	5
FRD032P	200	0.30	210	14/23	5
FRD034P	250	0.30	220	14/23	2
FRD036P	500	0.50	260	19/26	2
FRD038P	1000	0.80	300	24/29	2
FRD040P	2000	1.20	370	29/32	1
FRD042P	5000	2.40	475	34/35	1







 Rubber stoppers not supplied.

## Flasks, volumetric, Col Lisse, class A

**MBL®**

- Complies with ISO 1042
- With plain neck to accept rubber stopper
- Manufactured from borosilicate glass
- Finely calibrated to Class A tolerances
- Conformity 'H' certified
- Individually laser etched with serial number, batch code and date of manufacture
- Batch certificate available to download online
- Blue enamel inscriptions

Product Code	Capacity (ml)	Tol. (+/- ml)	Approx height (mm)	Neck I.D. (mm)	Pack qty.
FRD200	5	0.025	70	7	5
FRD202	10	0.025	90	7	5
FRD204	20	0.04	110	9	5
FRD206	25	0.04	110	9	5
FRD208	50	0.06	140	11	5
FRD210	100	0.10	170	13	5
FRD212	200	0.15	210	15	5
FRD214	250	0.15	220	16	2
FRD216	500	0.25	260	19	2
FRD218	1000	0.40	300	23	2
FRD220	2000	0.60	370	27	1
FRD222	5000	1.20	475	42	1





## Flasks, volumetric, class A, PMP (TPX)



- Manufactured from glass-clear PMP offering excellent clarity
- Individually adjusted ring-mark to class A tolerances according to ISO 1042
- Batch performance certificate available to download online
- Supplied with polypropylene stopper

Product Code	Capacity (ml)	Tol. (+/- ml)	Height with stopper (mm)	Socket size	Pack qty.
DFD112A	25	0.04	115	10/19	1
DFD118A	50	0.06	150	12/21	1
DFD124A	100	0.10	180	14/23	1
DFD130A	250	0.15	235	19/26	1
DFD136A	500	0.25	270	19/26	1
DFD138A	1000	0.40	310	24/29	1

 Cleaning up to max. 60°C is recommended to preserve marks and inscriptions.

 Downloadable batch certificates are available from [www.scilabware.com](http://www.scilabware.com)

## Flasks, volumetric, class B, PMP (TPX)



- Manufactured from transparent PMP offering excellent clarity
- Clear easy to read calibration line
- Calibrated to ISO 1042, class B tolerances
- Supplied with polypropylene stopper

Product Code	Capacity (ml)	Tol. (+/- ml)	Height with stopper (mm)	Socket size	Pack qty.
FDF112N	25	0.08	115	10/19	1
FDF118N	50	0.12	150	12/21	1
FDF124N	100	0.20	180	14/23	1
FDF130N	250	0.30	235	19/26	1
FDF136N	500	0.50	270	19/26	1
FDF138N	1000	0.80	310	24/29	1



 Exposure to temperatures up to 121°C (autoclaving) will not cause permanent exceeding of tolerance limits.

 Cleaning up to max. 60°C is recommended to preserve marks and inscriptions.

## Flasks, volumetric, class B, polypropylene



- Manufactured from translucent polypropylene giving good durability
- Clear easy to read calibration line
- Calibrated to ISO 1042, class B tolerances
- Supplied with polypropylene stopper

Product Code	Capacity (ml)	Tol. (+/- ml)	Height with stopper (mm)	Socket size	Pack qty.
FDF012N	25	0.08	115	10/19	1
FDF018N	50	0.12	150	12/21	1
FDF024N	100	0.20	180	14/23	1
FDF030N	250	0.30	235	19/26	1
FDF036N	500	0.50	270	19/26	1
FDF038N	1000	0.80	310	24/29	1



 Exposure to temperatures above 60°C may affect accuracy and remove marks and inscriptions.

# Flasks, flow indicator, fractionation



## Flasks, Kohlrausch, class A

**MBL®**

- Complies with BS 615
- With expanded neck for easy introduction of viscous liquids or solid samples
- 2 sizes available:
  - 100ml for sugar analysis
  - 200ml for determination of oil viscosity by Engler method
- Calibrated to Class A tolerances
- White enamel inscriptions
- Manufactured from soda-lime glass

Product Code	Capacity (ml)	Tol. (+/- ml)	Approx height (mm)	Pack qty.
FRE011	100	0.06	155	2
FRE013	200	0.10	185	2



## Flow indicator, PMP (TPX)

*A E Azlon*

- Simple but highly effective device to show flow of liquid or gas
- Transparent robust moulding with a coloured paddle wheel
- Operates at low flow rates. (The impeller starts to turn at 150ml/min)
- Stepped side arms are tapered to accept tubing from 6 - 11mm I.D.

Product Code	Overall length (mm)	Capacity (ml)	Pack qty.
FWY053	90	10	1

**i** Maximum 2 bar operating pressure. Maximum 60°C operating temperature.

**!** Not suitable for use with strong acids / alkalis or solvents.



## Fractionating columns, plain

**PYREX QUICKFIT® U.K.**

- Borosilicate glass with Quickfit® ground-glass joints for dependable performance
- Designed for use with various types of column packing e.g. Raschig rings or Fenske helices

Product Code	Approx surface area (x 10 <sup>-2</sup> m <sup>2</sup> )	Socket size	Cone size	Approx effective length (mm)	Approx overall length (mm)	Pack qty.
FC7/23	2.0	24/29	24/29	250	365	1
FC7/43	4.0	24/29	24/29	500	615	1

**i** The Quickfit® range of C2: air condensers listed on page 98 can also be used as fractionating columns.

## Column packing support



- Designed to support Raschig rings within plain fractionating columns
- Support is passed through socket of column and rests at the constriction above the cone
- Manufactured from chemically resistant borosilicate glass

Product Code	Fits socket size	Diam. (mm)	Pack qty.
EX13/12	19/26	16	1
EX13/23	24/29	21	1
EX13/25	34/35	29	1
EX13/26	40/38	35	1



## Column packing, Raschig rings



- For use with Quickfit® plain fractionating columns
- Raschig rings - short lengths of glass tubing
- Supplied in 1 litre bags
- Manufactured from borosilicate glass for contamination-free performance

Product Code	Approx diam. (mm)	Approx length (mm)	Pack qty.
FC8/06	6	6	1
FC8/09	9	9	1



To support the packing within the column, the use of packing supports EX13: series is recommended.

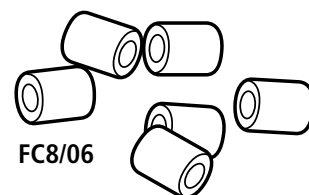

## Fractionating columns, Vigreux



- Popular, easy to use column
- Vigreux type with combination of horizontal and angled indentations
- Horizontal indentations ensure intimate vapour and liquid contact
- Angled indentations redistribute liquid from walls to centre of column

Product Code	Socket size	Cone size	Approx effective length (mm)	Sets of points	Pack qty.
FC3/00	10/19	10/19	100	4	1
FC3/13	24/29	24/29	360	7	1
FC3/23	24/29	24/29	600	12	1
FC3/14	29/32	29/32	360	7	1



# Fractionation

## Fractionating columns, Dufton



- Comprises of a column with accurately fitted Dufton glass spiral
- Good efficiency - liquid spiralling down column meets ascending vapour
- Spiral can be removed for cleaning

Product Code	Socket size	Cone size	Approx effective length (mm)	Approx overall height (mm)	Pack qty.
FC1/12	19/26	19/26	150	270	1
FC1/22	19/26	19/26	300	425	1
FC2/13	24/29	24/29	150	290	1
FC2/23	24/29	24/29	300	435	1



## Distillation head, Reflux Divider



- Fits on the top of a fractionating column to provide an effective liquid dividing head
- With integral jacketed condenser
- Liquid leaving condenser is directed towards a GP Rotaflo® stopcock
- Adjustment of stopcock controls proportion of liquid returned to the column or collected
- Screwcap fitting for insertion of thermometer
- Side-arm for venting or connection to vacuum supply

Product Code	Cone size to fit column	Cone size to fit receiver	Screwthread size (mm)	Stopcock bore (mm)	Condenser surface area (x 10 <sup>-2</sup> m <sup>2</sup> )	Pack qty.
SH30/42/SC	29/32	19/26	13	3.0	4.0	1



## Funnels, short stem

**PYREX®**

- With 60° bowl angle for precise fitting of filter paper
- Manufactured from chemical and heat resistant Pyrex® borosilicate glass

Product Code	Top external diam. (mm)	Stem O.D. (mm)	Stem length (mm)	Overall height (mm)	To suit filter paper diam. (mm)	Pack qty.
2140/01M	35	8	35	60	45-55	10
2140/02M	45	8	45	78	55-70	10
2140/03M	70	8	75	125	70-90	10
2140/06M	80	8	82	144	90-150	10
2140/10M	105	10	106	186	150-185	10
2140/11M	125	12	122	220	185-240	1
2140/12M	150	16	154	270	240-270	1
2140/14M	200	24	193	345	320-385	1



## Funnels, long stem

**PYREX®**

- With 60° bowl angle for precise fitting of filter paper
- Manufactured from chemical and heat resistant Pyrex® borosilicate glass
- Stem length approximately 150mm

Product Code	Top external diam (mm)	Stem O.D. (mm)	Overall height (mm)	To suit filter paper diam. (mm)	Pack qty.
2145/03M	70	8	205	70-90	10
2145/06M	80	8	215	90-150	10
2145/10M	105	8	237	150-185	10



# Funnels



## Funnels, lightweight, polypropylene



- Lightweight polypropylene funnels with ribs that prevent air locks, allowing rapid filtration
- Autoclavable to 121°C

Product Code	Top I.D. (mm)	Stem O.D. at tip (mm)	Overall height (mm)	Pack qty.
FWC052	30	2	47	10
FWC054	30	5	47	10
FWC056	40	5	62	10
FWC058	50	9	78	10
FWC060	75	10	107	10
FWC062	100	13	149	10
FWC064	120	14	170	5
FWC066	150	17	210	5



## Funnels, industrial, HDPE



- Rigid industrial funnels in polyethylene
- Unbreakable in normal use
- Suitable for food contact applications in accordance with EU and USA regulations
- Feature straight sided upper rims to prevent spillage

Product Code	Top I.D. (mm)	Stem O.D. (mm)	Overall height (mm)	Pack qty.
FWC102	80	9	80	10
FWC104	100	11	102	10
FWC106	120	12	121	10
FWC108	140	13	141	5
FWC110	180	17	181	5
FWC112	230	21	226	5
FWC114	245	24	239	1
FWC116	290	27	277	1
FWC118	380	36	351	1



For information on food safety please refer to the technical section.

## Funnels, powder, plain stem

PYREX®

- Ideal for transferring powders
- With short wide stem for smooth flow
- Manufactured from chemically resistant Pyrex® borosilicate glass

Product Code	Top diam. funnel (mm)	Stem O.D. x length (mm)	Pack qty.
2130/02M	80	18 x 25	10



## Funnels, powder, stem with cone



- Designed for transferring powders into Quickfit® flasks and vessels
- With Quickfit® ground glass cone
- Manufactured from chemically-resistant Pyrex® borosilicate glass

Product Code	Cone size	Approx funnel diam. (mm)	Pack qty.
CF5/1	14/23	105	1
CF5/2	19/26	105	1
CF5/3	24/29	105	1
CF5/4	29/32	105	1
CF5/5	34/35	105	1



## Funnels, powder, polypropylene



- Lightweight polypropylene powder funnel
- Unbreakable in normal use
- Parallel stem minimises 'bridging' of powder to improve flow
- The two largest sizes have vertical sided tops

Product Code	Top I.D. (mm)	Stem O.D. (mm)	Overall height (mm)	Pack qty.
FWC202	65	18	69	5
FWC204	80	22	74	5
FWC206	100	26	90	5
FWC208	120	30	106	5
FWC210	150	31	135	5
FWC212	290	35	208	1
FWC214	420	48	270	1





# Funnels



## Funnels, thistle, polypropylene



- Polypropylene thistle shaped funnel with detachable long stem
- Stem dimensions: 6mm O.D. x 4mm I.D. x 250mm long
- Stem can be cut to size

Product Code	Approx funnel diam. (mm)	Pack qty.
FWC220	34	10



## Funnels, filter, ribbed

**PYREX®**

- With interior 'ribs' to increase the filtration rate
- Robust construction in Pyrex® borosilicate glass
- Stem length of 150mm

Product Code	Top external diam. (mm)	Stem O.D. (mm)	Overall height (mm)	To suit filter paper diam. (mm)	Pack qty.
2150/03M	65	8	196	70-90	10
2150/06M	80	8	210	90-150	10
2150/10M	110	8	235	150-185	10



## Funnels, sintered glass disc

**PYREX®**

- Sintered disc manufactured from Pyrex® borosilicate glass
- For the filtration of solutions:
  - No requirement for filter paper
  - Resistant to most corrosive reagents including ammonia and concentrated sulphuric acid
- Available in a choice of porosities

Product Code	Nom. capacity (ml)	Porosity grade	Bowl I.D. (mm)	Overall height (mm)	Stem O.D. x length (mm)	Pack qty.
3730/04	20	2	65	130	8 x 75	5
3730/06	20	3	65	130	8 x 75	5
3730/08	20	4	65	130	8 x 75	5
3750/03	30	3	80	144	8 x 82	1



3730 series have 20mm diameter sintered discs, 3750 series have 30mm diameter sintered discs.

## Funnels, filter, micro

PYREX®

- With 15mm diameter sintered disc
- Ideal for filtering small amounts of material

Product Code	Nom. capacity (ml)	Porosity grade	Body O.D. (mm)	Height exc. stem (mm)	Stem O.D. x length (mm)	Pack qty.
3780/02M	8	1	18	135	8 x 40	5
3780/04M	8	2	18	135	8 x 40	5
3780/06M	8	3	18	135	8 x 40	5
3780/08M	8	4	18	135	8 x 40	5



## Funnels, filter, sintered glass disc cylindrical

PYREX®

- Manufactured from Pyrex® borosilicate glass
- Ideal for filtering precipitates
- 3770 series 20mm diameter sintered discs
- 3760 series 30mm diameter sintered discs

Product Code	Nom. capacity (ml)	Porosity grade	Body O.D. (mm)	Overall height (mm)	Pack qty.
3760/02	130	1	34	300	1
3760/04	130	2	34	300	1
3760/06	130	3	34	300	1
3770/02	50	1	24	160	2
3770/04	50	2	24	160	2
3770/06	50	3	24	160	2
3770/08	50	4	24	160	2
3770/10	50	5	24	160	2





## Funnels, filter, sintered glass disc, Büchner, 30mm diameter

**PYREX®**

- Comprehensive range of Büchner filter funnels with integral sintered glass discs
- Disc and funnel body manufactured from chemically resistant Pyrex® glass
- For convenient filtration of solutions
  - No filter papers required
  - Highly resistant to most corrosive reagents including ammonia and concentrated sulphuric acid
- Choice of disc diameters and porosities

Product Code	Nom. capacity (ml)	Porosity grade	Diam. of rim (mm)	Overall height (mm)	Stem O.D. x length (mm)	Pack qty.
3620/02	30	1	38	160	8 x 100	5
3620/04	30	2	38	160	8 x 100	5
3620/06	30	3	38	160	8 x 100	5
3620/08	30	4	38	160	8 x 100	5
3620/10	30	5	38	160	8 x 100	5

## Funnels, filter, sintered glass disc, Büchner, 40mm diameter

Product Code	Nom. capacity (ml)	Porosity grade	Diam. of rim (mm)	Overall height (mm)	Stem O.D. x length (mm)	Pack qty.
3630/01	50	0	54	170	8 x 100	5
3630/02	50	1	54	170	8 x 100	5
3630/04	50	2	54	170	8 x 100	5
3630/06	50	3	54	170	8 x 100	5
3630/08	50	4	54	170	8 x 100	5
3630/10	50	5	54	170	8 x 100	5

## Funnels, filter, sintered glass disc, Büchner, 60mm diameter

Product Code	Nom. capacity (ml)	Porosity grade	Diam. of rim (mm)	Overall height (mm)	Stem O.D. x length (mm)	Pack qty.
3700/01	125	0	71	180	13 x 100	5
3700/02	125	1	71	180	13 x 100	5
3700/04	125	2	71	180	13 x 100	5
3700/06	125	3	71	180	13 x 100	5
3700/08	125	4	71	180	13 x 100	5
3700/10	125	5	71	180	13 x 100	5

## Funnels, filter, sintered glass disc, Büchner, 95mm diameter

PYREX®

- Comprehensive range of Büchner filter funnels with integral sintered glass discs
- Disc and funnel body manufactured from chemically resistant Pyrex® glass
- For convenient filtration of solutions
  - No filter papers required
  - Highly resistant to most corrosive reagents including ammonia and concentrated sulphuric acid
- Choice of disc diameters and porosities

Product Code	Nom. capacity (ml)	Porosity grade	Diam. of rim (mm)	Overall height (mm)	Stem O.D. x length (mm)	Pack qty.
3710/01	500	0	106	250	19 x 100	5
3710/02	500	1	106	250	19 x 115	5
3710/04	500	2	106	250	19 x 115	5
3710/06	500	3	106	250	19 x 115	5
3710/08	500	4	106	250	19 x 115	5
3710/10	500	5	106	250	19 x 115	5



## Funnels, filter, sintered glass disc, Büchner, 120mm diameter

Product Code	Nom. capacity (ml)	Porosity grade	Diam. of rim (mm)	Overall height (mm)	Stem O.D. x length (mm)	Pack qty.
3720/02M	1000	1	135	290	19 x 120	2
3720/04M	1000	2	135	290	19 x 120	2
3720/06M	1000	3	135	290	19 x 120	2
3720/08M	1000	4	135	290	19 x 120	2

## Funnels, filter, sintered glass disc, Büchner, 175mm diameter

Product Code	Nom. capacity (ml)	Porosity grade	Diam. of rim (mm)	Overall height (mm)	Stem O.D. x length (mm)	Pack qty.
3722/02M	4000	1	190	390	30 x 150	1
3722/04M	4000	2	190	390	30 x 150	1
3722/06M	4000	3	190	390	30 x 150	1
3722/08M	4000	4	190	390	30 x 150	1



For advice on the choice of sinter porosity, please refer to the technical section of the catalogue.



## Funnels, filter, Büchner, stem with cone



- Büchner funnel with glass sintered disc
- Borosilicate glass construction for high resistance to chemical attack
- Useful where conventional filter papers would be destroyed by acids and alkalis
- Integral ground glass cone on stem for connecting to Quickfit® Büchner flasks etc.

Product Code	Nom. capacity (ml)	Cone size	Approx disc diameter (mm)	Approx funnel diam. (mm)	Sintered disc porosity	Pack qty.
SF3A32	125	19/26	55	71	3	1
SF3A33	125	24/29	55	71	3	1
SF3A34	125	29/32	55	71	3	1
SF3B33	500	24/29	95	106	3	1



## Funnels, filter, vacuum Büchner



- Büchner vacuum filtration funnel with glass sintered disc
- Manufactured from borosilicate glass for highest resistance to chemical attack
- Useful where conventional filter papers would be destroyed by acids and alkalis
- With a Quickfit® ground glass cone to allow direct filtration into Quickfit® Büchner flasks

Product Code	Nom. capacity (ml)	Porosity grade	Disc diam. (mm)	Diam. of rim (mm)	Cone size	Overall height (mm)	Pack qty.
VB30/06M	30	3	30	40	19/26	50	1
VB30/08M	30	4	30	40	19/26	50	1
VB40/02M	80	1	40	50	24/29	52	1
VB40/04M	80	2	40	50	24/29	52	1
VB40/06M	80	3	40	50	24/29	52	1
VB40/08M	80	4	40	50	24/29	52	1
VB60/02M	125	1	60	71	24/29	48	1
VB60/04M	125	2	60	71	24/29	48	1
VB60/06M	125	3	60	71	24/29	48	1
VB60/08M	125	4	60	71	24/29	48	1
VB95/04M	500	2	95	106	29/32	95	1
VB95/06M	500	3	95	106	29/32	95	1
VB95/08M	500	4	95	106	29/32	95	1



Vacuum conical flasks sold separately

## Funnels, filter, vacuum Hirsch

PYREX®

- Hirsch pattern vacuum filtration funnel with sintered glass disc
- Manufactured from Pyrex® borosilicate glass for high resistance to chemical attack
- Ideal for filtering semi-micro quantities of material

Product Code	Cone size	Approx disc diameter (mm)	Approx funnel diam. (mm)	Sintered disc porosity	Pack qty.
3766/03	14/23	12	35	3	



## Funnels, sintered glass disc, conical, stem with cone



- Conical shape with glass sintered disc
- Resistant to most corrosive reagents
  - Ammonia, sulphuric acid, etc.
- With integral ground glass cone on the stem for connecting to Quickfit® Büchner flasks

Product Code	Cone size	Approx disc diameter (mm)	Approx funnel diam. (mm)	Sintered disc porosity	Pack qty.
SF4A32	19/26	20	45	3	1
SF4B32	19/26	30	80	3	1



## Funnels, filter, semi-micro



- Ideal for filtering semi-micro quantities of material
- Fitted with borosilicate glass sintered disc
- Suitable for use with Quickfit® MD: range of receivers

Product Code	Cone size	Approx disc diameter (mm)	Approx funnel diam. (mm)	Sintered disc porosity	Pack qty.
SF4T30	10/19	10	30	3	1
SF4T31	14/23	10	30	3	1



# Funnels



## Semi-micro filter receivers



- With side-arm for venting or attachment to vacuum supply
- Ideal for use with Quickfit® semi-micro filter funnels SF4T30 and SF4T31

Product Code	Nom. capacity (ml)	Socket size	Approx overall height (mm)	Pack qty.
MD60	5	10/19	95	1
MD61	10	14/23	130	1



## Funnels, filter, perforated plate



- With a perforated glass plate (not a sintered disc)
- Plate acts as a support for standard laboratory filter papers
- Useful for quantitative work where recovery of the precipitate is desired

Product Code	Cone size	Approx plate diam. (mm)	Approx funnel diam. (mm)	Pack qty.
SF42/2	19/26	24	55	1



## Funnels, dropping, graduated, PTFE key

**MBL®**

- Complies to ISO 4800, Type 4
- Manufactured from borosilicate glass
- With double graduated scale showing approx. volume contained/volume dispensed
- Graduations in white enamel
- With interchangeable PTFE stopcock for grease-free performance
- Supplied with polyethylene stopper

Product Code	Capacity (ml)	Grads. (ml)	Lowest grad. mark (ml)	Stopcock bore (mm)	Stopper size	Stopcock	Pack qty.
FST511	50	1	5	1.5	19/26	SST102K	1
FST521	100	2	10	1.5	19/26	SST102K	1
FST531	250	5	25	2.5	24/29	SST103K	1
FST542	500	10	50	4.0	24/29	SST105K	1
FST552	1000	20	100	4.0	29/32	SST105K	1

## Funnels, dropping, graduated, PTFE key, with cone **PYREX®**

- Complies with ISO 4800, Type 4
- With interchangeable PTFE key for grease free performance
- Double graduated scale showing volume of liquid contained/delivered
- Stem inside cone for easy fitting to Quickfit® assemblies
- Graduations in white enamel

Product Code	Capacity (ml)	Grads. (ml)	Lowest grad. mark (ml)	Stopcock bore (mm)	Cone and socket size	Stopcock	Pack qty.
443333	50	1	5	1.5	19/26	SST102K	1
443340	100	2	10	1.5	19/26	SST102K	1
443347	250	5	25	2.5	29/32	SST103K	1
443354	500	10	50	4.0	29/32	SST105K	1
443360	1000	20	100	4.0	29/32	SST105K	1



## Funnels, dropping, Rotaflo® stopcock, stem with cone



- Complies to ISO 4800, Type 3
- Funnel stem with ground-glass cone for easy incorporation into the sockets of Quickfit® flasks etc.
- Fitted with GP Rotaflo® stopcock with PTFE key
  - No lubrication required
  - No contaminating greases
  - No seizure with caustic solutions

Product Code	Nom. capacity (ml)	Stopcock bore (mm)	Cone size	Socket size	Stopcock	Pack qty.
D1/11GP	50	3.0	14/23	14/23	GP3K	1
D1/21GP	100	3.0	14/23	14/23	GP3K	1
D1/22GP	100	3.0	19/26	19/26	GP3K	1
D1/32GP	250	3.0	19/26	24/29	GP3K	1
D1/42GP	500	6.0	19/26	24/29	GP6K	1
D1/62GP	1000	6.0	19/26	29/32	GP6K	1





# Funnels



## Funnels, dropping, Rotaflo® stopcock, open top, with cone



- Complies with ISO 4800, Type 3
- With stem inside the cone
- Enables easy fitting to the top of Quickfit® chromatography columns etc where a protruding stem would be undesirable
- GP Rotaflo® stopcock with PTFE key for grease-free performance
- With open top instead of socket for easy addition of solutions

Product Code	Nom. capacity (ml)	Top I.D. (mm)	Stopcock bore (mm)	Cone size	Stopcock	Pack qty.
D3/12	50	28	3.0	19/26	GP3K	1
D3/22	100	39	3.0	19/26	GP3K	1
D3/32	250	47	3.0	19/26	GP3K	1



## Funnels, dropping, graduated, glass key

**PYREX®**

- Complies with ISO 4800, Type 4
- Manufactured from Pyrex® borosilicate glass
- With double graduated scale showing approximate volume contained/dispensed
- Graduations in white enamel
- With interchangeable glass key
- Supplied with glass stopper

Product Code	Capacity (ml)	Grads. (ml)	Lowest grad. mark (ml)	Stopper size	Stopcock bore (mm)	Stopcock	Pack qty.
3590/01	50	1	5	19/26	2.0	SSD102K	1
3590/02	100	2	10	19/26	2.5	2392/22	1
3590/04	250	5	25	24/29	2.5	SSD103K	1
3590/06	500	10	50	24/29	4.0	2392/24	1
3590/08	1000	20	100	29/32	4.0	2392/24	1



Spare glass stoppers are detailed on page 258.

## Funnels, dropping, graduated, glass key, with cone PYREX®

- Complies with ISO 4800, Type 4
- With interchangeable glass key
- Double graduated scale showing volume of liquid contained/delivered
- Stem inside cone for easy fitting to Quickfit® assemblies
- Graduations in white enamel

Product Code	Capacity (ml)	Grads. (ml)	Lowest grad. mark (ml)	Stopcock bore (mm)	Cone and socket size	Stopcock	Pack qty.
443334	50	1	5	2.5	19/26	2392/22	1
443341	100	2	10	2.5	19/26	2392/22	1
443348	250	5	25	2.5	29/32	SSD103K	1
443355	500	10	50	4.0	29/32	2392/24	1
443361	1000	20	100	4.0	29/32	2392/24	1



## Funnels, dropping, glass key, stem with cone



- Complies with ISO 4800, Type 3
- Funnel stem with ground-glass cone for easy incorporation into Quickfit® flasks and assemblies
- Stopcock has interchangeable glass key

Product Code	Nom. capacity (ml)	Stopcock bore (mm)	Cone size	Socket size	Stopcock	Pack qty.
D1/11	50	2.0	14/23	14/23	SSD102K	1
D1/21	100	2.5	14/23	14/23	2392/22	1
D1/22	100	2.5	19/26	19/26	2392/22	1
D1/32	250	2.5	19/26	24/29	SSD103K	1
D1/42	500	4.0	19/26	24/29	2392/24	1
D1/62	1000	4.0	19/26	29/32	2392/24	1



 Stoppers for use with Quickfit® dropping funnels are detailed on page 256.

# Funnels



## Funnels, pressure equalising, pear shape, Rotaflo® stopcock



- Complies with ISO 4800, Type 2
- For use when liquids have to be introduced into vessels under vacuum
- Can also be used with Soxhlets as solvent traps to facilitate recovery at the end of an extraction
- With GP Rotaflo® stopcocks having chemically resistant PTFE keys

Product Code	Nom. capacity (ml)	Stopcock bore (mm)	Cone size	Socket size	Stopcock	Pack qty.
DE100/22	100	3.0	19/26	19/26	GP3K	1
DE100/32	100	3.0	19/26	24/29	GP3K	1
DE250/32	250	3.0	19/26	24/29	GP3K	1
DE250/33	250	3.0	24/29	24/29	GP3K	1
DE250/44	250	3.0	29/32	29/32	GP3K	1
DE250/55	250	3.0	34/35	34/35	GP3K	1



## Funnels, pressure equalising, cylindrical, graduated, PYREX® PTFE key

- Complies with ISO 4800, Type 4
- With interchangeable PTFE key for grease free performance
- Double graduated scale showing volume of liquid contained/delivered
- For use when liquids have to be added to systems under vacuum
- Stem inside cone for easy fitting to Quickfit® assemblies
- Graduations in white enamel
- Supplied with hollow glass stopper

Product Code	Capacity (ml)	Grads. (ml)	Lowest grad. mark (ml)	Stopcock bore (mm)	Cone and socket size	Stopcock	Pack qty.
443533	50	1	5	1.5	19/26	SST102K	1
443540	100	2	10	1.5	19/26	SST1025K	1
443547	250	5	25	2.5	29/32	SST103K	1
443554	500	10	50	4.0	29/32	SST105K	1
443560	1000	20	100	4.0	29/32	SST105K	1

## Funnels, pressure equalising, cylindrical, graduated, PYREX® glass key

- Complies with ISO 4800, Type 4
- With interchangeable glass key
- Double graduated scale showing volume of liquid contained/delivered
- For use when liquids have to be added to systems under vacuum
- Stem inside cone for easy fitting to Quickfit® assemblies
- Graduations in white enamel
- Supplied with hollow glass stopper

Product Code	Capacity (ml)	Grads. (ml)	Lowest grad. mark (ml)	Stopcock bore (mm)	Cone and socket size	Stopcock	Pack qty.
443534	50	1	5	1.5	19/26	SSD102K	1
443541	100	2	10	1.5	19/26	2392/22	1
443548	250	5	25	2.5	29/32	SSD103K	1
443555	500	10	50	4.0	29/32	2392/24	1
443561	1000	20	100	4.0	29/32	2392/24	1



## Funnels, separating, pear-shape, PTFE key

- Complies with ISO 4800, Type 2
- Borosilicate glass construction
- With PTFE key for non-stick grease-free performance
- Supplied with polyethylene stopper

**MBL®**

Product Code	Nom. capacity (ml)	Stopcock bore (mm)	Stopper size	Stopcock	Pack qty.
FST211	50	1.5	19/26	SST102K	1
FST221	100	1.5	19/26	SST102K	1
FST231	250	2.5	24/29	SST103K	1
FST242	500	4.0	24/29	SST105K	1
FST252	1000	4.0	29/32	SST105K	1
FST274	2000	6.0	29/32	SST106K	1
FST276	5000	6.0	34/35	SST106K	1



 FST276 is supplemental to the ISO 4800

# Funnels



## Funnels, separating, conical, PTFE key

**MBL®**

- Complies with ISO 4800, Type 1
- Manufactured from borosilicate glass
- With PTFE key for grease-free and corrosion-resistant performance
- Supplied with polyethylene stopper

Product Code	Nom. capacity (ml)	Stopcock bore (mm)	Stopper size	Stopcock	Pack qty.
FST311	50	1.5	19/26	SST102K	1
FST321	100	1.5	19/26	SST102K	1
FST331	250	2.5	24/29	SST103K	1
FST342	500	4.0	24/29	SST104K	1
FST352	1000	4.0	29/32	SST104K	1
FST374	2000	6.0	29/32	SST106K	1



Spare polyethylene stoppers are available on page 258.



## Funnels, separating, Gilson, PTFE key

**PYREX®**

- Gilson style separating funnel with long delivery stem for good control of the liquid/liquid interface
- With interchangeable PTFE key for grease free performance
- Supplied with hollow glass stopper

Product Code	Nom. capacity (ml)	Stopcock bore (mm)	Stopper size	Stopcock	Pack qty.
443038N	60	1.5	14/23	SST102K	1
443042N	125	1.5	19/26	SST102K	1
443047N	250	2.5	24/29	SST103K	1
443054N	500	4.0	24/29	SST105K	1
443060N	1000	4.0	29/32	SST105K	1
443065N	2000	4.0	29/32	SST105K	1
443073N	4000	6.0	34/35	SST106K	1



For spare glass stoppers, please see page 256.

## Funnels, separating, pear-shape, Rotaflo® stopcock



- Complies with ISO 4800, Type 2
- Manufactured from borosilicate glass
- With GP Rotaflo® PTFE stopcock:
  - No lubrication required
  - No contaminating greases
  - No seizure

Product Code	Nom. capacity (ml)	Stopcock bore (mm)	Socket size	Stopcock	Pack qty.
D52/50	50	3.0	19/26	GP3K	1
D52/100	100	3.0	19/26	GP3K	1
D52/250	250	3.0	24/29	GP3K	1
D53/500	500	6.0	24/29	GP6K	1
D24/1L	1000	6.0	29/32	GP6K	1



## Funnels, separating, pear-shape, Rotaflo® stopcock, stem with cone



- Complies with ISO 4800, Type 2
- Funnel stem with ground-glass cone to facilitate connection to apparatus having Quickfit® sockets
- With GP Rotaflo® stopcock having chemically resistant PTFE key

Product Code	Nom. capacity (ml)	Stopcock bore (mm)	Cone size	Socket size	Stopcock	Pack qty.
D2/11GP	50	3.0	14/23	14/23	GP3K	1
D2/21GP	100	3.0	14/23	14/23	GP3K	1
D2/22GP	100	3.0	19/26	19/26	GP3K	1
D2/31GP	250	3.0	14/23	24/29	GP3K	1
D2/32GP	250	3.0	19/26	24/29	GP3K	1
D2/42GP	500	6.0	19/26	24/29	GP6K	1
D2/43GP	500	6.0	24/29	24/29	GP6K	1
D2/62GP	1000	6.0	19/26	29/32	GP6K	1



Spare Rotaflo® keys are available on page 250.

# Funnels



## Funnels, separating, conical, Rotaflo® stopcock



- Complies with ISO 4800, Type 1
- Manufactured from borosilicate glass
- With GP Rotaflo® PTFE stopcock:
  - No lubrication required
  - No contaminating greases
  - No seizure

Product Code	Nom. capacity (ml)	Stopcock bore (mm)	Socket size	Stopcock	Pack qty.
D91/100	100	3.0	14/23	GP3K	1
D92/100	100	3.0	19/26	GP3K	1
D93/250	250	3.0	24/29	GP3K	1
D93/500	250	6.0	24/29	GP6K	1



## Funnels, separating, pear-shape, glass key

**PYREX®**

- Complies with ISO 4800, Type 2
- Manufactured from Pyrex® glass for corrosion-free performance
- With interchangeable glass key
- Supplied with glass stopper

Product Code	Nom. capacity (ml)	Stopcock bore (mm)	Stopper size	Stopcock	Pack qty.
2180/02M	50	2.0	19/26	SSD102K	1
2180/04M	100	2.0	19/26	SSD102K	1
2180/06M	250	2.5	24/29	SSD103K	1
2180/08M	500	4.0	24/29	2392/24	1
2180/10M	1000	4.0	29/32	2392/24	1
2180/12M	2000	6.0	29/32	SSD106K	1
2180/14M	5000	6.0	34/35	SSD106K	1

 5L size supplementary to ISO range.

## Funnels, separating, pear-shape, glass key, stem with cone



- Complies with ISO 4800, Type 2
- Funnel stem with cone to allow easy connection to Quickfit® flasks etc.
- Stopcock features interchangeable glass key

Product Code	Nom. capacity (ml)	Stopcock bore (mm)	Cone size	Socket size	Stopcock	Pack qty.
D2/01	25	2.0	14/23	14/23	SSD102K	1
D2/11	50	2.0	14/23	14/23	SSD102K	1
D2/12	50	2.0	19/26	19/26	SSD102K	1
D2/21	100	2.0	14/23	14/23	SSD102K	1
D2/22	100	2.0	19/26	19/26	SSD102K	1
D2/31	250	2.5	14/23	24/29	SSD103K	1
D2/32	250	2.5	19/26	24/29	SSD103K	1
D2/42	500	4.0	19/26	24/29	2392/24	1
D2/43	500	4.0	24/29	24/29	2392/24	1
D2/62	1000	4.0	19/26	29/32	2392/24	1



 For hollow glass stoppers, please refer to page 256. 25ml size supplementary to ISO range.

## Funnels, separating, conical, glass key

PYREX®

- Complies to ISO 4800, Type 1
- Manufactured from chemically resistant Pyrex® borosilicate glass
- With interchangeable ground glass key
- Supplied with glass stopper

Product Code	Nom. capacity (ml)	Stopcock bore (mm)	Stopper size	Stopcock	Pack qty.
2190/01M	50	2.0	14/23	SSD102K	1
2190/02M	100	2.0	19/26	SSD102K	1
2190/04M	250	2.5	24/29	SSD103K	1
2190/06M	500	4.0	24/29	2392/24	1
2190/08M	1000	4.0	29/32	2392/24	1
2190/10M	2000	6.0	29/32	SSD106K	1





# Funnels, gas wash bottles

**New**



## Funnels, separating, Gilson, glass key

**PYREX®**

- Gilson style separating funnel with long delivery stem for good control of the liquid/liquid interface
- With interchangeable glass key for grease free performance
- Supplied with hollow glass stopper

Product Code	Capacity (ml)	Stopcock bore (mm)	Stopper size	Stopcock	Pack qty.
443039N	60	2.0	14/23	SSD102K	1
443043N	125	2.0	19/26	SSD102K	1
443048N	250	2.5	24/29	SSD103K	1
443055N	500	4.0	24/29	2392/24	1
443061N	1000	4.0	29/32	2392/24	1
443066N	2000	4.0	29/32	2392/24	1
443074N	4000	4.0	34/35	2392/24	1



For spare glass stoppers, please see page 258.



## Dreschel bottle heads, screwthread connections



- Complies with BS 2461
- Drechsel type
- With detachable plastic connectors for easy fitting of 9mm bore flexible tubing

Product Code	Cone size	Approx. stem length (mm)	To fit bottle	Pack qty.
MF28/3/125/SC	24/29	130	MF29/3/125	1
MF28/3/250/SC	24/29	175	MF29/3/250	1
MF28/3/500/SC	24/29	215	MF29/3/500	1



Head and bottle should be ordered separately.



## Dreschel bottle head, adjustable



- With screwthread joint which allows height adjustment of the dip tube and hence permits use with either 125ml or 250ml Dreschel bottles
- To fit MF29: series wash bottles

Product Code	Cone size	Thread size (mm)	Sidearm O.D. (mm)	Pack qty.
MF27/3/13	24/29	13	7	1



Head and bottle should be ordered separately.

## Dreschel bottle heads, sintered



- Complies with BS 2461
- Sintered dip tube disperses gas into bubbles for greater efficiency
- Choice of sinter porosities to achieve fine bubble size

Product Code	Porosity grade	Stem length (mm)	Sidearm O.D. (mm)	Cone size	To fit bottle	Pack qty.
MF48/03/125	0	132	8	24/29	MF29/3/125	1
MF48/03/250	0	165	8	24/29	MF29/3/250	1
MF48/03/500	0	217	8	24/29	MF29/3/500	1
MF48/13/125	1	132	8	24/29	MF29/3/125	1
MF48/13/250	1	165	8	24/29	MF29/3/250	1
MF48/13/500	1	217	8	24/29	MF29/3/500	1
MF48/23/250	2	165	8	24/29	MF29/3/250	1
MF48/23/500	2	217	8	24/29	MF29/3/500	1
MF48/33/250	3	165	8	24/29	MF29/3/250	1

 Heads and bottles should be ordered separately. Finer porosity sinters, e.g. 2 and 3, provide smaller gas bubbles - though a greater pressure may be required.

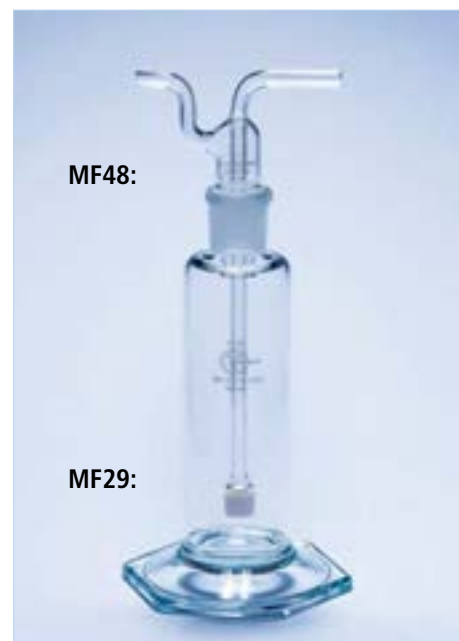

## Dreschel bottles



- For use with Quickfit® bottle heads
- Borosilicate glass for corrosion-free performance
- Robust construction

Product Code	Capacity (ml)	Socket size	Diameter across flat base (mm)	Overall height (mm)	Pack qty.
MF29/3/125	125	24/29	102	163	1
MF29/3/250	250	24/29	102	200	1
MF29/3/500	500	24/29	125	252	1



# Ice buckets



## Ice bucket with lid, polyurethane



- Black, green and blue skinned polyurethane foam ice buckets
- Suitable for use with water-ice, dry-ice and salt solutions
- Ideal for separating work areas by colour
- Supplied with lids
- Integral handles allow easy lifting and carrying
- Octagonal shape for easy stacking and stability
- Capacity 4.5 litres
- Dimensions 185 x 330mm (h x w) and weight 1200g

Product Code	Colour	Pack qty.
IBB001P	Black	1
IBB002P	Pale Blue	1
IBB003P	Green	1



*Not suitable for use with solvents or liquid nitrogen.*



## Mini ice bucket



- Skinned polyurethane foam mini ice buckets
- Suitable for use with water-ice, dry-ice and salt solutions
- Integral handles allow easy lifting and carrying
- Tapered for easy stacking and stability
- Capacity 1000ml
- Dimensions 95mm x 200mm (h x w) and weight 140g

Product Code	Colour	Pack qty.
IBB004P	Green	1



*Not suitable for use with solvents or liquid nitrogen.*

## Imhoff sedimentation cone

**MBL®**

- Complies to DIN 12672
- For determining the amount of sediment in sewage or industrial waste
- Graduated up to a capacity mark at 1000ml
- Manufactured from borosilicate glass

Product Code	Capacity (ml)	Pack qty.
CRF530	1000	1

 Can be used with stands as detailed below.



## Imhoff sedimentation cone, SAN



- Colourless cone made from transparent styrene-acrylonitrile S.A.N polymer with moulded graduations
- Complies to DIN 12672
- Graduations from 2 to 1000ml (in mixed graduations)
- The bottom end has a stopper to facilitate removal of sample and cleaning

Product Code	Capacity (ml)	Pack qty.
SWX008	1000	1

## Sedimentation rack, PMMA

- Accepts 2 sedimentation cones side-by-side
- Locating recesses in the base for stability

Product Code	Description	Pack qty.
SWX004	Double stand	1



# Jerrycans, joints



## Jerrycans, rigid HDPE



- Lightweight and robust
- Corrosion resistant
- Ideal for storage and transportation of liquid chemicals
- Suitable for food contact applications in accordance with EU and USA regulations

Product Code	Capacity (litres)	Pack qty.
JGH140	1	1
JGH148	5	1
JGH150	10	1
JGH154	25	1



## Joints, cones, unbadged



- Unbadged ground glass cones free from any ceramic markings
- Avoids the problem of the badge charring at high temperatures which can give an untidy appearance
- Manufactured to an accuracy which surpasses the requirements of ISO 383
- Pyrex® borosilicate glass for resistance to chemical corrosion and thermal shock
- Cones manufactured with a shank length of 100mm

Product Code	Cone size	O.D. of shank (mm)	Bore (mm)	Wall thickness (mm)	Pack qty.
CNB7UB	7/16	6.0	2.5	1.50	10
CNB10UB	10/19	9.0	5.0	1.00	10
CNB12UB	12/21	11.4	6.5	1.50	10
CNB14UB	14/23	14.0	8.5	1.50	10
CNB19UB	19/26	18.0	12.0	1.80	10
CNB24UB	24/29	23.0	16.5	1.80	10
CNB29UB	29/32	28.0	21.0	2.00	10
CNB34UB	34/35	33.5	26.0	2.00	10
CNB40UB	40/38	38.8	31.0	2.00	5
CNB45UB	45/40	43.0	35.2	2.30	5
CNB50UB	50/42	49.0	41.8	2.30	5
CNB55UB	55/44	53.0	45.4	2.50	5
CNB60UB	60/46	57.0	47.2	3.50	5

 CNB55UB is supplementary to the ISO range.

## Joins, cones, drip end, unbadged



- Single Quickfit® cones with angled drip end
- Ideal for Glassblowers fabricating apparatus where liquid needs to be directed away from the joint
  - condensers, fractionating columns, still heads, etc.
- Manufactured to an accuracy which surpasses the requirements of ISO 383
- Drip end cones manufactured with a shank length of 90mm

Product Code	Cone size	O.D. of shank (mm)	Bore (mm)	Wall thickness (mm)	Pack qty.
CAB10	10/19	8.0	5.0	1.00	10
CAB14	14/23	13.0	6.0	1.50	10
CAB19	19/26	18.0	9.0	1.80	10
CAB24	24/29	22.5	13.0	2.00	10
CAB29	29/32	28.0	18.0	2.00	10
CAB34	34/35	32.0	21.0	2.00	10



## Joins, cones, long tip, unbadged



- Single Quickfit® cones with long tip allowing cone to be joined to glass tubing
- Useful for construction of stirrer guides etc.
- Unbadged and free from ceramic markings - avoids the problem of the badge charring at high temperatures which can give an untidy appearance
- Long tip cones manufactured with a minimum shank length of 90mm

Product Code	Cone size	O.D. of shank (mm)	Bore (mm)	Wall thickness (mm)	Pack qty.
CBB7UB	7/16	6.0	2.0	1.50	10
CBB10UB	10/19	8.0	3.0	1.00	10
CBB14UB	14/23	13.0	6.0	1.50	10
CBB19UB	19/26	18.0	8.0	1.80	10
CBB24UB	24/29	22.5	14.0	2.00	10
CBB29UB	29/32	28.0	19.0	2.00	10
CBB34UB	34/35	32.0	22.0	2.00	10
CBB40UB	40/38	38.0	27.0	2.00	10
CBB45UB	45/40	42.0	31.0	2.30	10
CBB55UB	55/44	52.0	40.0	2.50	10





## Joints, cone with stem



- Single Quickfit® cone with stem and reduced shank
- Useful for construction of gas-inlet tubes etc.
- Stem length 150mm

Product Code	Cone size	Min. shank length (mm)	O.D. of shank (mm)	Bore (mm)	Min. wall thickness (mm)	Pack qty.
MF15/1	14/23	45	7.4	4.4	0.9	1
MF15/2	19/26	60	10.4	6.2	1.3	1
MF15/3	24/29	70	10.4	6.0	1.3	1



## Joints, sockets, unbadged



- Unbadged ground glass sockets
  - Free from any ceramic markings
  - Avoids the problem of the badge charring at high temperatures which can give an untidy appearance
- High quality joints manufactured to an accuracy which surpasses the requirements of ISO 383
- Accurate taper and fine surface finish reduce possibility of joint 'seizure' or leakage
- With round profile bead on top of socket for extra mechanical strength
- Sockets manufactured with a minimum shank length of 100mm

Product Code	Socket size	O.D. of shank (mm)	Bore (mm)	Wall thickness (mm)	Pack qty.
SRB7UB	7/16	11.4	5.5	1.50	10
SRB10UB	10/19	14.0	8.0	1.50	10
SRB12UB	12/21	16.4	10.0	1.80	10
SRB14UB	14/23	18.4	12.0	1.80	10
SRB19UB	19/26	23.0	16.0	2.00	10
SRB24UB	24/29	28.5	21.0	2.00	10
SRB29UB	29/32	33.5	26.0	2.00	10
SRB34UB	34/35	41.0	31.0	2.00	10
SRB40UB	40/38	46.0	36.0	2.30	5
SRB45UB	45/40	53.0	41.0	2.50	5
SRB50UB	50/42	57.0	45.5	2.50	5
SRB55UB	55/44	66.5	50.0	3.20	5
SRB60UB	60/46	71.5	55.0	3.20	1

### Joins, sleeves, PTFE, tapered



- For grease free and high vacuum seals using Quickfit® ground glass joints
- Strong construction with knurled shoulder for ease of handling and repeated use
- Self-lubricating and non contaminating
- Suitable for food contact applications in accordance with USA regulations
- Manufactured from USP Class VI grade PTFE
- Working temperature range -100°C to +260°C
- Working vacuum  $\leq 10^{-3}$  atmospheres
- Highly resistant to chemical attack
- Forms a liquid and gas tight seal



Product Code	Joint size	Pack qty.
SWN802	10/19	1
SWN804	14/23	1
SWN806	19/26	1
SWN808	24/29	1
SWN810	29/32	1
SWN812	34/35	1

### Joins, sleeves, PTFE



- Truncated cone of pure PTFE
- Allows easy separation of joints
- Excellent resistance to chemical attack
- Working temperature range of -100°C to +250°C
- Forms a gas tight seal
- No contamination from joint grease
- Suitable for food contact applications in accordance with USA regulations
- Manufactured from USP Class VI grade PTFE
- Intended for single or occasional use
- Suitable for low vacuum work



Product Code	Joint size	Pack qty.
SWN961	14/23	10
SWN962	19/26	10
SWN963	24/29	10
SWN964	29/32	10
SWN965	34/35	10
SWN966	40/38	10
SWN968	50/42	10
SWN969	55/44	10





 Joint clips are intended to complement traditional clamping methods. Whilst they can considerably reduce the need for clamping, they should not be solely relied on to support heavy or large apparatus.

## Joint clips (PTFE), conical joints



- For retaining glassware having Quickfit® conical joints
- Manufactured from PTFE with encapsulated steel spring to provide a firm grip
- Highly resistant to chemical attack
- Can be used at temperatures up to 250°C
- Clips are numbered with joint size for easy identification

Product Code	Joint size	Pack qty.
GC10	10/19	5
GC12	12/21	5
GC14	14/23	5
GC19	19/26	5
GC24	24/29	5
GC29	29/32	5
GC34	34/35	5
GC40	40/38	5
GC45	45/40	5



 Whilst joint clips can considerably reduce the need for traditional clamping, they should not be solely relied on to support heavy or large apparatus.

## Joint clips (Polyacetal), conical joints



- For retaining glassware having Quickfit® conical joints
- Manufactured from polyacetal
- Can considerably reduce the need for clamping
- Easy to fit and remove
- Can be used at temperatures up to 80°C
- Clips are colour coded for easy identification

Product Code	Joint size	Colour code	Pack qty.
KC10	10/19	Mint	10
KC12	12/21	Violet	10
KC14	14/23	Yellow	10
KC19	19/26	Blue	10
KC24	24/29	Green	10
KC29	29/32	Red	10
KC34	34/35	Orange	10
KC40	40/38	Ochre	10
KC45	45/40	Brown	10

 These clips should not be exposed to halogen gases or acids which can rapidly attack polyacetal. For such applications, the use of Quickfit® PTFE joint clips should be considered.

## Joins, flat flange



- Highest quality flat flange joins
- Precision ground for leak-free performance
- Choice of sizes up to 100mm bore

Product Code	Nom. bore (mm)	Min. shank length (mm)	O.D. of shank (mm)	Outside diam. flange (mm)	Min. wall thickness (mm)	Pack qty.
FG25	25	110	30.8	55	1.8	2
FG50	50	110	57.0	85	2.2	2
FG75	75	110	86.8	120	4.4	2
FG100	100	110	116.0	150	4.0	1



## Joint clips (metal)



- For retaining glassware having Quickfit® flat flange joins
- Metal construction available in 2 versions:
  - JC: clips with 'fork' type design and corrosion-resistant nickel finish. Each clip is spring loaded to ensure a positive pressure is applied to both surfaces of the joint. Suitable for joint size, FG25
  - JC:F clips with 'spring wire' design in stainless steel. Suitable for joint sizes FG50, FG75 and FG100

Product Code	To fit joint size	Pack qty.
JC29	FG10	5
JC41	FG25	2
JC51	FG35	2
JC50F	FG50	1
JC75F	FG75	1
JC100F	FG100	1

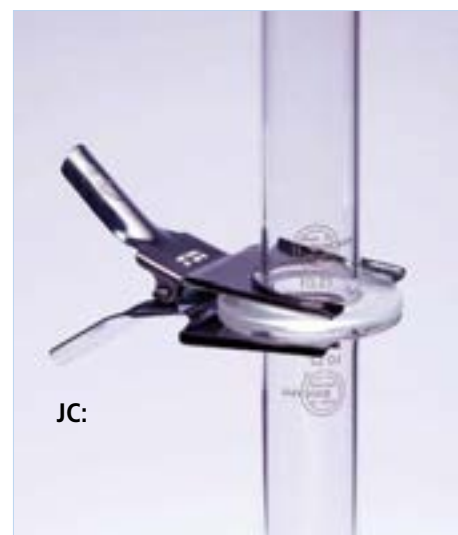

JC:



JC:F



## PTFE Seals



- For use with Quickfit® flat flange jointed glassware
- Manufactured from PTFE for excellent chemical resistance
- Forms tight seal with flat flange joints

Product Code	Flange bore (mm)	Thickness (mm)	Pack qty.
PS75	75	0.5	1
PS100	100	0.5	1



## Joints, spherical, male, ball joint, unbadged



- For the Glassblower who demands the highest quality joint
- Manufactured to an accuracy which surpasses the requirements of ISO 641
- Intended for use with female spherical cup joints FS:
- Spherical joints are manufactured with an approximate shank length of 100mm

Product Code	Joint size	O.D. of shank (mm)	Wall thickness (mm)	Pack qty.
MS13UB	S13	8.0	1.5	10
MS19UB	S19	12.0	1.5	10
MS29UB	S29	19.0	2.5	10
MS35UB	S35	24.0	2.5	1
MS41UB	S41	28.0	2.8	1



## Joints, spherical, female, cup joint, unbadged



- Female cup joints precision manufactured to the highest standards
- For use with male ball joints MS:
- Spherical joints are manufactured with an approximate shank length of 100mm

Product Code	Joint size	O.D. of shank (mm)	Wall thickness (mm)	Pack qty.
FS13UB	S13	8.0	1.5	10
FS19UB	S19	12.0	1.5	10
FS29UB	S29	19.0	2.5	10
FS35UB	S35	24.0	2.5	1
FS41UB	S41	28.0	2.8	1

## Joint clips (metal), spherical joints



- For retaining glassware having Quickfit® spherical joints
- Metal construction with corrosion-resistant nickel finish
- Suitable for high temperature work
- Spring loaded to ensure a positive pressure is applied to both surfaces of the joint

Product Code	To fit spherical joint size	Pack qty.
JC13	S13	5
JC19	S19	5
JC29	S29	5
JC35	S35	2
JC41	S41	2
JC51	S51	2



## Joint clips (Polyacetal), spherical joints



- For retaining glassware having Quickfit® spherical joints
- Manufactured from polyacetal
- Can considerably reduce the need for clamping
- Easy to fit and remove
- Can be used at temperatures up to 80°C
- Clips are colour coded for easy identification

Product Code	To fit joint size	Colour code	Pack qty.
KS13	S13	Violet	5
KS19	S19	Dark Blue	5
KS29	S29	Dark Red	5
KS35	S35	Light Orange	5



 Whilst joint clips can considerably reduce the need for traditional clamping, they should not be solely relied on to support heavy or large apparatus.

 These clips should not be exposed to halogen gases and acids which can rapidly attack polyacetal. For such applications, the use of Quickfit® PTFE joint clips should be considered.

## Joints, spherical, male/female glass joints

- Offers a 'grease-free' spherical joint
- All glass and PTFE pathway is highly resistant to chemical attack
- Can be used at temperatures up to 200°C
- System comprises male ball joint with PTFE covered 'O' ring which fits into a female cup joint
- Joint can be retained together with spring loaded metal clip

Component parts RM, RF, RO and RC should be ordered separately

Product Code	Joint size	O.D. of shank (mm)	Approx bore (mm)	Wall thickness (mm)	Pack qty.
RM13	13	8	5	1.5	5
RM19	19	12	9	1.5	5
RM29	29	18	15	1.8	5
RM35	35	24	20	1.8	5
RM41	41	28	25	2.8	5
RM64	64	45	40	2.3	5
RF13	13	8	5	1.5	5
RF19	19	12	9	1.5	5
RF29	29	18	15	1.8	5
RF35	35	24	20	1.8	5
RF41	41	28	25	2.8	5
RF64	64	45	40	2.3	5

## Joints, spherical, PTFE 'O' ring

Product Code	Description	Pack qty.
RO13	'O' ring to fit RM:RF13	1
RO19	'O' ring to fit RM:RF19	1
RO29	'O' ring to fit RM:RF29	1
RO35	'O' ring to fit RM:RF35	1
RO41	'O' ring to fit RM:RF41	1
RO64	'O' ring to fit RM:RF64	1

## Joints, spherical, Viton, 'O' ring

Product Code	Description	Pack qty.
690-12	'O' ring to fit RM:RF13	10
690-13	'O' ring to fit RM:RF19	10
690-14	'O' ring to fit RM:RF29	10
690-15	'O' ring to fit RM:RF35	10
690-16	'O' ring to fit RM:RF41	10

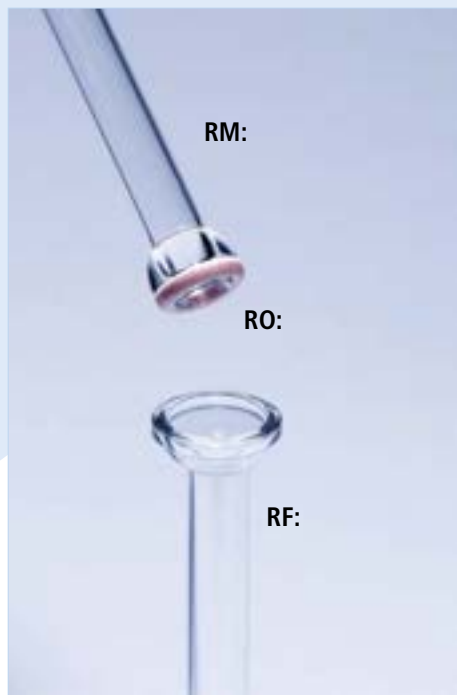

Minimum shank length of joint is 150mm. Component parts RM, RF, RO, RC: and 690: should be ordered separately. For joint clips see page 205.

## JOINTS, SPHERICAL, METAL CLIP

ROTULEX®

- Spring loaded metal clips for Rotulex® spherical joints

Product Code	Description	Pack qty.
RC13	Metal clip to fit RM:RF13	1
RC19	Metal clip to fit RM:RF19	1
RC29	Metal clip to fit RM:RF29	1
RC35	Metal clip to fit RM:RF35	1
RC41	Metal clip to fit RM:RF41	1
RC64	Metal clip to fit RM:RF64	1



## JOINTS, SCREWTHREAD, UNBADGED



- For use by Glassblowers in the construction of laboratory glassware
- Borosilicate glass for highest resistance to thermal shock and chemical corrosion
- Designed for use with the range of plastic screwcaps silicone rubber rings and PTFE washers

Product Code	Thread size (mm)	Min. shank length (mm)	Outside diam. shank (mm)	Bore (mm)	Pack qty.
SQ13UB	13	135	11.1	7.5	10
SQ18UB	18	145	15.4	10.5	10
SQ24UB	24	125	22.5	15.5	10
SQ28UB	28	90	24.5	19.7	10



**i** Unbadged screwthread joints are free from any ceramic inscriptions thus avoiding the aesthetic problem of 'charring' when the badge is subjected to direct heat. SQ13UB screwthread is compatible with 4510/02 and 4510/04 screwthread connectors featured on page 104.

## Joints, screwthread fittings, caps, rings & washers



- For use with Quickfit® glass screwthreads
- Melamine screwcaps with aperture at the top
- Silicone rubber rings with PTFE washers
- To determine what components are required:
  - i) Check the size of the glass screwthread (size designation refers to O.D. of thread in mm)
  - ii) Check the O.D. of the sampling tube, thermometer, probe etc that is to be passed through the screwcap
  - iii) Consult the table below remembering to order relevant cap, washer and ring separately

### Plastic caps

Product Code	Thread size (mm)	Acceptable dia. through screwcap (mm)	Pack qty.
QC13/7	13	6.0 - 7.0	10
QC18/11	18	7.0 - 8.5	10
QC24/12	24	6.0 - 7.0	10
QC28/9	28	6.0 - 7.0	10
QC28/13	28	10.5 - 11.5	10
QC28/21	28	18.0 - 19.0	10

### Rubber rings

Product Code	Thread size (mm)	Acceptable dia. through screwcap (mm)	Pack qty.
QR13/6	13	6.0-7.0	10
QR18/10	18	6.0-7.0	10
QR18/7	18	7.0-8.5	10
QR24/6	24	6.0-7.0	10
QR24/9	24	8.5-9.5	10
QR24/11	24	10.5-11.5	10
QR28/6	28	6.0-7.0	10
QR28/11	28	10.5-11.5	10
QR28/18	28	18.0-19.0	10

### PTFE washers

Product Code	Thread size (mm)	Acceptable dia. through screwcap (mm)	Pack qty.
QW13/6	13	6.0-7.0	10
QW18/7	18	7.0-8.5	10
QW24/6	24	6.0-7.0	10
QW24/9	24	8.5-9.5	10
QW24/11	24	10.5-11.5	10
QW28/6	28	6.0-7.0	10
QW28/11	28	10.5-11.5	10
QW28/18	28	18.0-19.0	10

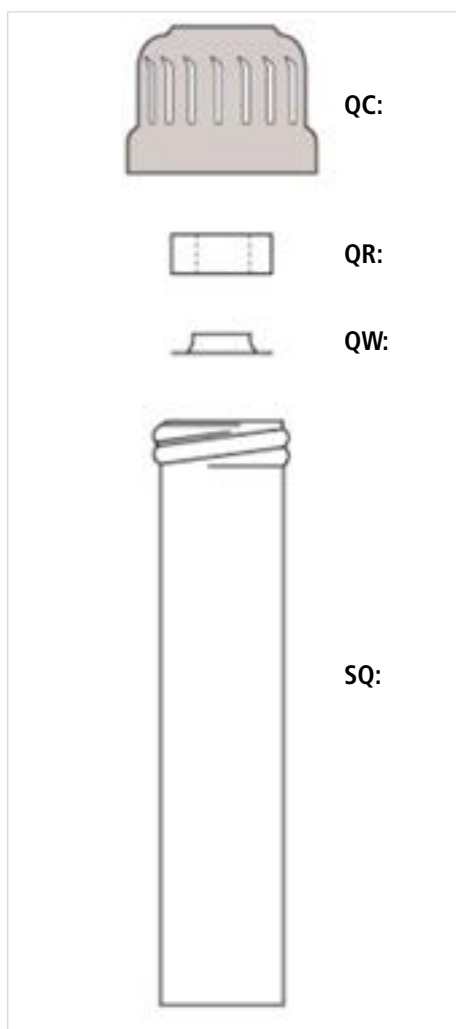

## Jugs, printed graduations, polypropylene

- Tapered jugs in high clarity polypropylene
- Suitable for food contact applications in accordance with EU and USA regulations
- Crisp blue printed graduations
- Autoclavable at 121°C
- Ergonomically designed handle

Product Code	Capacity (ml)	Sub div. (ml)	Rim diam. (mm)	Height (mm)	Pack qty.
JPB0050P	50	2	45	68	5
JPB0100P	100	2	61	72	5
JPB0250P	250	5	70	120	1
JPB0500P	500	10	90	140	1
JPB1000P	1000	10	104	180	1
JPB2000P	2000	50	150	214	1
JPB3000P	3000	50	152	240	1
JPB5000P	5000	100	200	270	1



## Jugs, moulded graduations, polypropylene

- Tapered jugs in high clarity polypropylene
- Suitable for food contact applications in accordance with EU and USA regulations
- Permanent moulded graduations
- Autoclavable at 121°C
- Ergonomically designed handle

Product Code	Capacity (ml)	Sub div. (ml)	Rim diam. (mm)	Height (mm)	Pack qty.
JPM0050P	50	2	45	68	5
JPM0100P	100	2	61	72	5
JPM0250P	250	5	70	120	1
JPM0500P	500	10	90	140	1
JPM1000P	1000	10	104	180	1
JPM2000P	2000	50	150	214	1
JPM3000P	3000	50	152	240	1
JPM5000P	5000	100	200	270	1





# Nitrogen determination

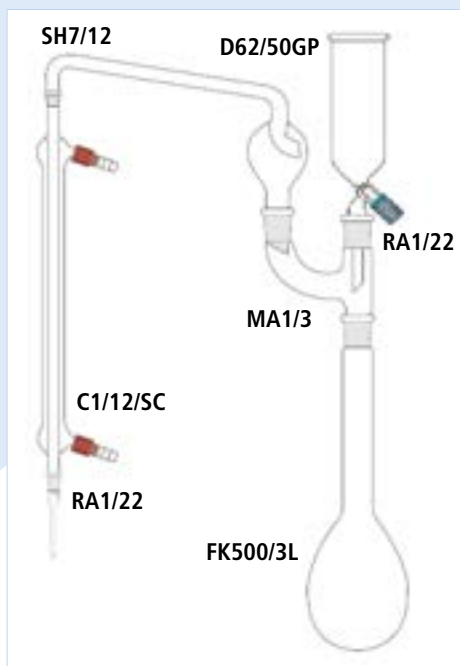

## Nitrogen determination (Kjeldahl) assembly



- Convenient assembly of Quickfit® glassware for Kjeldahl digestions and distillations
- Flask can be used alone for digestion stage and then fitted to rest of assembly for the distillation process
- Manufactured from heat resistant and chemically durable borosilicate glass

Product Code	Description	Pack qty.
280MC	Complete assembly	1



*The determination of nitrogen by the Kjeldahl method imposes severe demands on glassware including high temperatures coupled with alternating acid/alkali conditions.*



## Nitrogen determination, distillation unit, (Markham Still)



- Complies with BS1428: Part B2
- Enables a large number of distillations to be carried out in rapid succession
- Comprises Markham still body, Liebig condenser and connecting joint clip
- Still has evaporator vessel enclosed in a steam jacket
- When connected to a suitable steam supply the steam passes through the sample to promote distillation
- When steam supply is shut off the apparatus automatically sucks back any residue in the vessel thus preparing itself for the next determination

Product Code	Description	Pack qty.
46MC	Complete assembly	1



# Top of the class

When budgets are tight, you want a product that gives you real value for money.

The SciLabware range of MBL® volumetric products are made to the same world class standards of accuracy that you expect from our other famous brands of glassware, at affordable prices.

Ideal for use in a wide range of laboratories, MBL® burettes, cylinders, pipettes and volumetric flasks deliver consistent results time and again.

## MBL®

Glassware that ticks all the right boxes

Class A/AS ✓ Class B ✓ ISO ✓ DIN ✓

# Pipettes



**i** PRA748ASWC is supplementary to ISO standard. 1 and 2ml one mark pipettes are straight form and do not feature a bulb.

## Pipettes, one mark, class AS, works certified

**MBL®**

- Complies with ISO 648 and DIN 12691
- Calibrated for delivery with +5s waiting time
- Each pipette coded with individual serial number
- Supplied with calibration certificate which allows traceability to National Standards
- Markings in permanent amber stain which are fused into the glass ensuring highest resistance to aggressive cleaning solutions
- Manufactured from soda-lime glass with tooled jets for extra strength and to ensure correct outflow times

Product Code	Capacity (ml)	Tol. (+/- ml)	Delivery time seconds	Pack qty.
PRA740ASWC	1	0.008	7-11	2
PRA742ASWC	2	0.010	7-11	2
PRA744ASWC	5	0.015	9-13	2
PRA746ASWC	10	0.020	11-15	2
PRA748ASWC	15	0.030	12-16	2
PRA750ASWC	20	0.030	12-16	2
PRA752ASWC	25	0.030	15-20	2
PRA754ASWC	50	0.050	20-25	2
PRA756ASWC	100	0.080	25-30	2



**i** PRA728AS is supplementary to ISO standard. 1 and 2ml one mark pipettes are straight form and do not feature a bulb. Batch certificates are available to download from [www.scilabware.com](http://www.scilabware.com)

## Pipettes, one mark, class AS

**MBL®**

- Complies with ISO 648 and DIN 12691
- Calibrated for delivery
- Printed with batch code for downloadable batch certificate
- Markings in permanent amber stain
- Class AS with +5s waiting time
- Manufactured from soda-lime glass with robust tooled jets

Product Code	Capacity (ml)	Tol. (+/- ml)	Delivery time seconds	Pack qty.
PRA720AS	1	0.008	7-11	2
PRA722AS	2	0.010	7-11	2
PRA724AS	5	0.015	9-13	2
PRA726AS	10	0.020	11-15	2
PRA728AS	15	0.030	12-16	2
PRA730AS	20	0.030	12-16	2
PRA732AS	25	0.030	15-20	2
PRA734AS	50	0.050	20-25	2
PRA736AS	100	0.080	25-30	2

**Pipettes, one mark, class B****MBL®**

- Complies with ISO 648 and DIN 12690
- Calibrated for delivery
- Manufactured from soda-lime glass with tooled jets to reduce breakage
- Markings in permanent amber stain which are diffused into the surface of the glass for increased chemical resistance

Product Code	Capacity (ml)	Tol. (+/- ml)	Delivery time seconds	Pack qty.
PRA700B	1	0.015	5-20	5
PRA702B	2	0.020	5-25	5
PRA704B	5	0.030	7-30	5
PRA706B	10	0.040	8-40	5
PRA708B	15	0.060	9-50	5
PRA710B	20	0.060	9-50	5
PRA712B	25	0.060	10-50	5
PRA714B	50	0.100	13-60	5
PRA716B	100	0.150	25-60	2



*PRA708B is supplementary to ISO standard. 1 and 2ml one mark pipettes are straight form and do not feature a bulb.*

**Pipettes, one mark, class B, polypropylene**

- Calibrated to meet class B tolerances
- Permanently marked with ring and inscriptions
- Marked with blue inscriptions

Product Code	Capacity (ml)	Tol. (+/- ml)	Pack qty.
PDH601	1	0.02	12
PDH602	2	0.02	12
PDH605	5	0.03	12
PDH610	10	0.04	1
PDH625	25	0.05	1
PDH650	50	0.10	1



*Exposure to temperatures above 60°C may affect accuracy. Recommend cleaning with mild alkaline detergents.*



# Pipettes



## Pipettes, two mark, class AS

**MBL®**

- Complies with ISO 648 and DIN 12691
- Calibrated for delivery
- Printed with batch code for downloadable batch certificate
- Class AS with +5s waiting time
- Features a safety bulb at the top of the pipettes tube
- Manufactured from soda-lime glass with robust tooled jets and permanent amber stain

Product Code	Capacity (ml)	Tol. (+/- ml)	Delivery time seconds	Pack qty.
PRA620AS	1	0.008	7-11	2
PRA622AS	2	0.010	7-11	2
PRA624AS	5	0.015	9-13	2
PRA626AS	10	0.020	11-15	2
PRA630AS	20	0.030	12-16	2
PRA632AS	25	0.030	15-20	2
PRA634AS	50	0.050	20-25	2
PRA636AS	100	0.080	25-30	2



Batch certificates can be downloaded from [www.scilabware.com](http://www.scilabware.com)



## Pipettes, graduated, type 1, class AS, works certified

**MBL®**

- Complies with ISO 835
- Calibrated to deliver from zero at the top to any graduation line down to the shoulder
- Each pipette is calibrated to deliver with a waiting time of +5s
- Supplied with a calibration certificate showing actual volume dispensed and providing traceability to national standards
- Manufactured from soda-lime glass with tooled jets for extra strength and to ensure correct outflow times
- Graduations in permanent amber stain which resists aggressive washing solutions

Product Code	Capacity (ml)	Grads. (ml)	Tol. (+/- ml)	Delivery time seconds	Pack qty.
PRA780ASWC	1	0.01	0.007	4-10	2
PRA782ASWC	2	0.02	0.010	4-10	2
PRA784ASWC	5	0.05	0.030	7-13	2
PRA786ASWC	10	0.10	0.050	7-13	2
PRA788ASWC	25	0.10	0.100	11-17	2

**Pipettes, graduated, type 1, class AS****MBL®**

- Complies with ISO 835
- Calibrated to deliver from zero at the top to any graduation line down to the shoulder
- Graduations in permanent amber stain which resists aggressive washing solutions
- Each pipette is calibrated 'to deliver' with a +5s waiting time
- Manufactured from soda-lime glass with tooled jets for extra strength and to ensure correct outflow times

Product Code	Capacity (ml)	Grads. (ml)	Tol. (+/- ml)	Delivery time seconds	Pack qty.
PRA770AS	1	0.01	0.007	4-10	2
PRA772AS	2	0.02	0.010	4-10	2
PRA774AS	5	0.05	0.030	7-13	2
PRA776AS	10	0.10	0.050	7-13	2
PRA778AS	25	0.10	0.100	11-17	2



Batch certificates are available to download for all Class AS pipettes. To download a batch certificate, visit [www.scilabware.com](http://www.scilabware.com).

**Pipettes, graduated, type 1, class B****MBL®**

- Complies with ISO 835
- Calibrated to deliver from zero at the top to any graduation line down to the shoulder
- Graduations in permanent amber stain which withstands aggressive cleaning solutions
- Manufactured from soda-lime glass with robust tooled jets

Product Code	Capacity (ml)	Grads. (ml)	Tol. (+/- ml)	Delivery time seconds	Pack qty.
PRA760B	1	0.01	0.01	2-11	5
PRA762B	2	0.02	0.02	2-12	5
PRA764B	5	0.05	0.05	5-14	5
PRA766B	10	0.10	0.10	5-17	5
PRA768B	25	0.10	0.20	5-15	5



# Pipettes



## Pipettes, graduated, type 2, class AS, works certified

**MBL®**

- Complies with ISO 835
- Calibrated to deliver from any graduation line down to zero at the jet
- Each pipette is calibrated to deliver with a +5s waiting time
- Supplied with calibration certificate showing actual volume dispensed and providing traceability to National Standards
- Manufactured from soda-lime glass with tooled jets for extra strength and to ensure correct outflow times
- Graduations in permanent amber stain which are diffused into the glass to provide highest resistance to chemical attack

Product Code	Capacity (ml)	Grads. (ml)	Tol. (+/- ml)	Delivery time seconds	Pack qty.
PRA820ASWC	1	0.01	0.007	4-10	2
PRA822ASWC	2	0.02	0.010	4-10	2
PRA824ASWC	5	0.05	0.030	7-13	2
PRA826ASWC	10	0.10	0.050	7-13	2
PRA828ASWC	25	0.10	0.100	11-17	2



## Pipettes, graduated, type 2, class AS

**MBL®**

- Complies with ISO 835
- Calibrated to deliver from any graduation line down to zero at the jet
- Graduations in permanent amber stain which resists aggressive washing solutions
- Each pipette is calibrated 'to deliver' with a +5s waiting time
- Manufactured from soda-lime glass with tooled jets for extra strength and to ensure correct outflow times

Product Code	Capacity (ml)	Grads. (ml)	Tol. (+/- ml)	Delivery time seconds	Pack qty.
PRA810AS	1	0.01	0.007	4-10	2
PRA812AS	2	0.02	0.010	4-10	2
PRA814AS	5	0.05	0.030	7-13	2
PRA816AS	10	0.10	0.050	7-13	2
PRA818AS	25	0.10	0.100	11-17	2



*Class AS pipettes are marked with batch information. To download batch certificate simply visit the certificates section of [www.scilabware.com](http://www.scilabware.com).*

**Pipettes, graduated, type 2, class B****MBL®**

- Complies with ISO 835
- Calibrated to deliver from any graduation line down to zero at the jet
- Graduations in permanent amber stain which is fused into the glass to ensure highest resistance to aggressive washing solutions
- Manufactured from soda-lime glass with robust tooled jets

Product Code	Capacity (ml)	Grads. (ml)	Tol. (+/- ml)	Delivery time seconds	Pack qty.
PRA800B	1	0.01	0.01	2-11	5
PRA802B	2	0.02	0.02	2-12	5
PRA804B	5	0.05	0.05	5-14	5
PRA806B	10	0.10	0.10	5-17	5
PRA808B	25	0.10	0.20	9-21	5

**Pipettes, graduated, type 3, class B****MBL®**

- Complies with ISO 835
- Calibrated to deliver from zero at the top to any graduation line down to the jet
- Graduations in permanent amber stain which resists aggressive washing solutions
- Manufactured from soda-lime glass with robust tooled rims

Product Code	Capacity (ml)	Grads. (ml)	Tol. (+/- ml)	Delivery time seconds	Pack qty.
PRA830B	1	0.01	0.01	2-11	5
PRA832B	2	0.02	0.02	2-12	5
PRA834B	5	0.05	0.05	5-14	5
PRA836B	10	0.10	0.10	5-17	5
PRA838B	25	0.10	0.20	9-21	5





# Pipettes

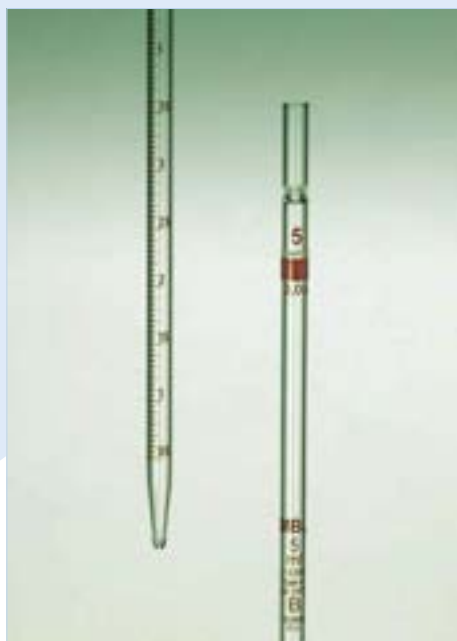

## Pipettes, graduated, serological, type 4, class B

**MBL®**

- Complies with ISO 835
- Calibrated to deliver from any graduation line down to zero at the jet with the last drop expelled by blowing
- Tooled suction ends accept cotton-wool plug
- Graduations in permanent amber stain
- Manufactured from soda-lime glass with robust tooled jets

Product Code	Capacity (ml)	Grads. (ml)	Tol. (+/- ml)	Delivery time seconds	Pack qty.
PRA840S	1	0.01	0.01	2-7	5
PRA842S	2	0.02	0.02	2-7	5
PRA844S	5	0.05	0.05	4-10	5
PRA846S	10	0.10	0.10	4-10	5
PRA848S	25	0.10	0.20	5-15	5



## Pipettes, graduated, class B, polypropylene

 **Azlon**

- Calibrated to class B tolerances
- Conforms to ISO 835
- Easy to read graduation lines
- Specially manufactured tip to ensure excellent quality

Product Code	Capacity (ml)	Grads. (ml)	Tol. (+/- ml)	Pack qty.
PDH501	1	0.10	0.02	12
PDH502	2	0.10	0.02	12
PDH505	5	0.10	0.05	12
PDH510	10	0.10	0.10	12



Exposure to temperatures above 60°C may affect accuracy. Recommend cleaning with mild alkaline detergents.

## Pipettes, dropping, polyethylene



- Corrosion resistant and unbreakable in normal use
- Both sizes are one-piece bellows dispensers
- Plain stem of 7.5 mm diameter

Product Code	Capacity (ml)	Stem length (mm)	Total length (mm)	Pack qty.
PDH402	1.5	98	133	100
PDH408	5	159	194	100



## Pasteur pipettes, unwadded

**MBL®**

- Complies with ISO 7712
- Single use Pasteur pipettes for the transfer of small volumes of liquid
- Manufactured from soda lime glass conforming to USP Type III requirements
- Pasteur pipettes have a tip internal diameter of 1.1mm
- Pipettes and teats should be ordered separately

Product Code	Description	Length (mm)	Capacity (ml)	Pack qty.
SPP002	Unwadded, open tip	150	2	1000
SPP004	Unwadded, open tip	230	2	1000



*Packed in four cartons containing 250 pipettes each and grouped together into a protective outer carton.*



## Teats for Pasteur pipettes

**MBL®**

- Choice of silicone and natural rubber teats for use with Soda-lime Pasteur pipettes

Product Code	Description	Pack qty.
BPP002	Clear silicone teats	100
BPP004	Red natural latex rubber teat	100

**New**

# Pipettes



## Pipette filler, Bibbette®

*Azlon*

- A novel PTFE and silicone rubber valve assembly controls the vacuum created by simply squeezing the unique rubber bulb
- By moving the thumb lever pipettes from 0.1ml up to 100ml can be easily and accurately filled and emptied
- Blow out pipettes are catered for by the depression of a small thumb operated squeeze ball
- A replaceable PTFE membrane filter ensures liquid is not accidentally drawn into the unit (2 supplied)
- The filter and pipette holding cone can be sterilised by autoclaving

Product Code	Description	Pack qty.
PFL001B	Bibbette pipette controller, Blue	1
PFL001N	Bibbette pipette controller, Plain	1

## Bibbette® accessories

Product Code	Description	Pack qty.
PFL002	Spare membrane filters pack of 10	10
PFL003	Spare suction bulb	1
PFL004	Spare valve system for Bibbette pipette controller	1
PFL006	Spare silicone adapter	1



## Pipette fillers, natural rubber

*Azlon*

- Suitable for pipettes up to 100ml
- Pipette filler works via a series of glass ball valves for air release, suction and delivery
- PWY145 is suitable for single handed operation
- PWY146 has an extended insert nozzle for improved grip

Product Code	Pack qty.
PWY144	1
PWY145	1
PWY146	1

### Operating instructions for PWY145



1. Evacuate via the automatic valve
2. Intake by pressure on operating point
3. Drain by pressure on operating point
4. Blow out the pipette (no valve actuation necessary)
5. Remove the valve for easy inside cleaning
6. Replace the valve using a twisting motion

### Pipette rack, HDPE



- White moulded polyethylene rack
- Will support 12 pipettes over 200 mm long
- Very stable
- Supplied as a kit of two end pieces and three connecting rods for easy push fit assembly



Product Code	Pack qty.
SWP038	1

### Pipette rinser, HDPE



- Automatic rinsing system ensuring rapid washing with high-quality results
- Suitable for use with pipette basket RDR306 and pre-cleaning jar RDR304
- Automatically rinses contents when connected to a tap and drain
- Rinses pipettes, burettes and other labware up to 600mm in length



Product Code	Diam. (mm)	Height (mm)	Usable length (mm)	Pack qty.
RDR302	165	740	600	1

 Not supplied with tubing

### Pipette rinser, pre-cleaning jar, HDPE



- For pre-cleaning pipettes in cleaning solution prior to rinsing in RDR302

Product Code	Diam. (mm)	Height (mm)	Pack qty.
RDR304	165	650	1



# Pipettes



## Pipette rinser, basket, HDPE



- For dipping pipettes into the pre-cleaning jar RDR304 or pipette rinser RDR302
- Suitable for transferring pipettes safely

Product Code	Diam. (mm)	Overall height (mm)	Carrier height (mm)	Pack qty.
RDR306	130	650	300	1



## Pipette stand, polypropylene



- Blue chemically resistant polypropylene stand
- Holds up to 94 pipettes vertically
- Very stable with 230mm diameter base
- Height of 470mm
- Has a rotatable rack suspended by a support rod

Product Code	Description	Pack qty.
SWP033	Pipette Stand	1



## Pipette sterilising boxes, polypropylene



- Unique cylindrical box for pipette sterilisation
- Autoclavable at 121°C
- The patented telescopic thread closure enables the box length to be altered from 280 to 500mm

Product Code	O.D. (mm)	Length (mm)	Pack qty.
PWP050	65	280-500	1

### Pipette support, polystyrene



- Moulded in white polystyrene
- Simple and efficient pipette rest
- An off-centre support means it is also suitable for short pipettes, burettes, syringes etc.

Product Code	l x w x h (mm)	Pack qty.
SWP036	280 x 215 x 38	1



### Pump, barrel, polypropylene



- Suitable for use with acids & alkalis
- Rigid discharge tube
- PTFE gaskets
- Immersion tube diameter 32mm x 1500mm long
- Can be used in conjunction with barrel plug PWJ004
- The pump has a two part sampling tube that screws together

Product Code	Overall length (mm)	Pack qty.
PWJ003	1590	1



### Barrel plug, PVC



- Tapered PVC bung for use with 40 - 70mm diameter openings
- Designed for barrel pump PWJ003 (30mm diameter tube)

Product Code	Description	Pack qty.
PWJ004	PVC barrel pump for 40 - 70mm diameter openings	1



# Pumps



## Pumps, polypropylene & PVC



- Can be used with various sizes of bottles due to telescopic down tube
- Liquid is forced into the collecting vessel by squeezing the bulb
- The flow can be instantly interrupted by pressing the release button
- Can be used as a siphon by attaching tubing to the outlet tube and after pumping the liquid will flow continuously

Product Code	Flow rate (litres/min)	Stopper O.D. (mm)	Tube O.D. x length mm	Pack qty.
PWJ014	4	28 / 44	10 x 450	1
PWJ016	14	44 / 60	12 x 700	1
PWJ018	20	52 / 68	15 x 700	1



Can be used with unistoppers below.



## Unistoppers, multipurpose, PVC



- For use with or without pumps PWJ014/PWJ016/PWJ018
- Consists of three parts, one core and two collars
- Can be used in container openings from 30 - 70mm diameter
- Has 2 apertures, one for inserting tubes and a smaller aperture which acts as an air vent to allow siphoning

Product Code	Description	Pack qty.
PWJ020	Unistopper with 12mm hole for PWJ016	1
PWJ021	Unistopper with 15mm hole for PWJ018	1



## Pump, water jet, polypropylene



- Suitable for most laboratory water pressures
- Integrated non-return valve increases safety
- Detachable vacuum connection - accepts 6-9mm bore tubing
- Supplied with water inlet hose connection and R 3/4" threaded tap connectors, with R 1/2" reduction adapter
- Water inlet hose connection accepts 10-12mm bore tubing
- Very low water consumption: 190 litre/h at 3.5 bar water supply pressure
- A pressure of 16 mbar (water temperature of 12°C) is achievable with a water supply pressure from 3 to 6 bar
- High suction capacity with a flow rate of approx. 400 litres/h of air (at 1 atm and water supply pressure of 3.5 bar at 12°C)

Product Code	Description	Pack qty.
PWD003	Water-jet vacuum pump	1



Jubilee clips are recommended to fix tubing into position.

## Racks, draining, coated



- High quality free standing or wall mounted draining racks
- Manufactured from polyamide epoxy coated steel
- Offers better heat and chemical resistance than other coatings
- There are eight pegs 110mm long and twenty four pegs 80mm in length. Peg diameter is 4.5mm
- Overall dimensions of the rack are 410 x 300mm

Product Code	Description	Pack qty.
RWK070FS	Rack with integral free standing support	1
RWK070	Wall mountable	1



RWK070 shown.



## Wall mountable draining rack, polystyrene



- Lightweight, easy to assemble polystyrene draining racks designed to be wall mounted
- Pegs simply slot into place on the back board and are spaced to allow various sizes of labware to fit on to the rack
- Water is collected in the trough at the base of the rack and drains away via a rubber tube which can be directed into a nearby sink or container
- Supplied with wall mounting accessories
- Measures approximately 650mm high x 450mm wide
- A set of narrow pegs for test tubes, volumetric flasks etc. is also available

Product Code	Description	Peg l x O.D. (mm)	Pack qty.
WRP001P	Rack, including 72 pegs, trough & drainage tubing	120 x 16	1
WRP002P	Set of 11 narrow pegs	100 x 6	1





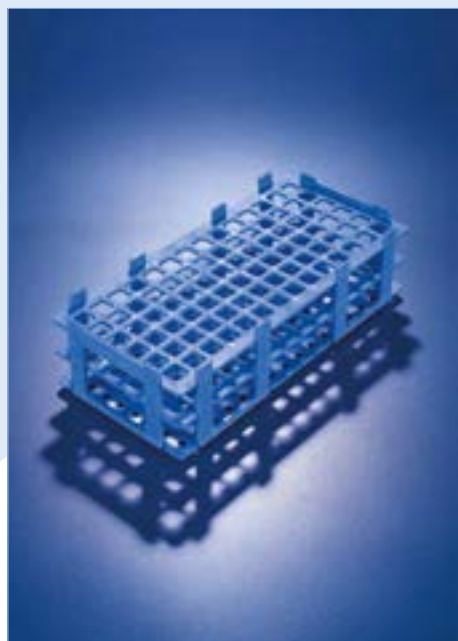

## Rack, test tube, polypropylene



- Economical and sturdy test tube racks supplied in self assembly flat packs
- Autoclavable at 121°C
- Sinks in water baths
- Alpha numeric place coding

Product Code	Colour	l x w x h (mm)	Max. tube O.D. (mm)	No. places	Pack qty.
RPB013P	Blue	265 x 126 x 75	13	84	5
RPW013P	White	265 x 126 x 75	13	84	5
RPB018P	Blue	265 x 126 x 75	18	55	5
RPW018P	White	265 x 126 x 75	18	55	5
RPB021P	Blue	265 x 126 x 75	21	40	5
RPW021P	White	265 x 126 x 75	21	40	5
RPB026P	Blue	265 x 126 x 88	26	32	5
RPW026P	White	265 x 126 x 88	26	32	5
RPB031P	Blue	265 x 126 x 88	31	21	5
RPW031P	White	265 x 126 x 88	31	21	5



## Racks, test tube, polyethylene



- Simple rack with six holes of 25mm diameter
- Shape ensures good visibility making the rack ideal for classroom work
- Also has 6 draining pegs
- Supplied flat and is very easy to assemble for use or disassemble for storage

Product Code	Material particular	Pack qty.
RWK030	Polyethylene	1

## Racks, microcentrifuge tube, polypropylene



- Economical and sturdy test tube racks supplied in self assembly flat packs
- Hole size 11mm square
- Accepts 128 x 1.5ml microcentrifuge tubes
- Autoclavable at 121°C
- Sinks in water baths
- Alpha numeric place coding

Product Code	Colour	l x w x h (mm)	No. places	Pack qty.
RPB001P	Blue	265 x 126 x 38	128	5
RPR001P	Red	265 x 126 x 38	128	5
RPW001P	White	265 x 126 x 38	128	5
RPY001P	Yellow	265 x 126 x 38	128	5



## Rack, microcentrifuge tube, polypropylene



- Microcentrifuge tube rack with numerical marking
- Autoclavable at 121°C
- Holds a maximum of 20 tubes

Product Code	Base dim. l x w x h (mm)	Hole diam. (mm)	Pack qty.
RWK058	210 x 70 x 35	10	1



## Hand/finger protectors, silicone rubber



- Ideal for safe handling of hot beakers, flasks etc.
- Capable of withstanding temperatures up to 250°C
- Also excellent for handling cold objects down to -57°C
- Contact surfaces are multi-studded for positive grip

Product Code	Description	Pack qty.
PGR402	Medium	1
PGR404	Small	1
PGR406	Finger	1





## Shields, beta radiation, acrylic



- High quality shields in 10mm thick acrylic protect against beta radiation
- Angled to allow comfortable working position when examining or handling samples

Product Code	Description	Shield angle degrees	Dimensions (h x w) (mm)	Pack qty.
SRS001	Angled shield	15°	445 x 165	1
SRS002	Dual angled shield	20°	445 x 150	1

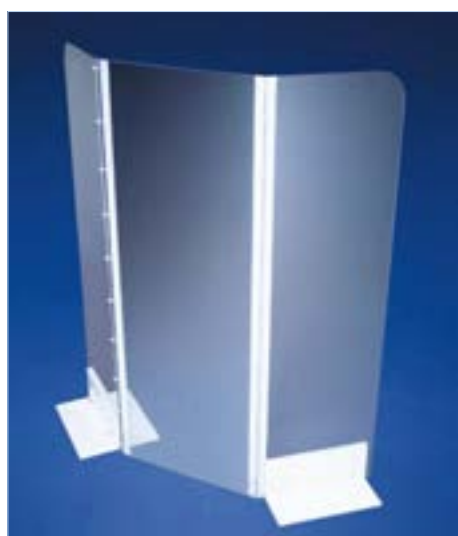

## Shield, safety, hinged type, polycarbonate



- Excellent protection in potentially hazardous situations
- Adjustable - can be used as a tight triangle or extended out to a straight line configuration
- Incredibly strong and lightweight
- Supplied with two pairs of plastic coated metal feet
- Feet may be clamped or bolted onto the bench to give greater stability

Product Code	Height (cm)	Outside panel widths (mm)	Centre panel width mm	Total width (mm)	Pack qty.
SGT002	38	180	230	590	1
SGT004	61	180	230	590	1
SGT006	61	226	300	750	1

## Shield, safety, hinged type, accessories

Product Code	Description	Pack qty.
SGT012	Spare shield feet	1
SGT014	Shield clamp with hand screw for securing shield feet to the bench	1



## Shield, safety, single piece, polycarbonate



- Excellent protection in potentially hazardous situations
- Incredibly strong and lightweight
- Manufactured from a single piece of 4mm thick sheet of transparent polycarbonate
- Supplied with two pairs of plastic coated metal feet
- Feet may be clamped or bolted onto the bench to give greater stability

Product Code	Height (mm)	Outside panel width (mm)	Centre panel width mm	Pack qty.
SGT102	608	178	230	1

## Mercury collector, polyethylene



- Spilled mercury is collected by pressing the foam pad in the screw top closure against the mercury
- The mercury is drawn into and encapsulated in the pad by releasing the pressure
- The mercury is released by screwing the closure on to the jar

Product Code	Description	Pack qty.
MWY850	Mercury collector	1
MWY851	Replacement pad	1



## Scoops, measuring, polypropylene



- Suitable for food contact applications in accordance with USA regulations
- Top is flat for levelling off powders
- Base is flat enabling scoops to stand horizontally
- The capacity is clearly moulded on each size

Product Code	Capacity (ml)	Overall length (mm)	Pack qty.
SWL002	2	60	5
SWL006	5	82	5
SWL008	10	102	5
SWL012	25	137	5
SWL018	50	160	5
SWL024	100	198	5
SWL030	250	259	5
SWL036	500	315	5
SWL140	1000	385	1



## Scoops, HDPE



- Sturdy scoops in natural rigid polyethylene
- Lightweight with good chemical resistance
- Suitable for food contact applications in accordance with USA regulations

Product Code	Max. capacity (ml)	Overall length (mm)	Pack qty.
SWL028	150	250	5
SWL033	750	350	5
SWL040	1250	405	1





## Quickfit® sets



Quickfit® sets are designed to cover the requirements of practical chemistry in its many different fields and levels. Capable of performing a range of organic chemistry experiments that includes simple reflux arrangements to more complex addition experiments.

- 29BU/M is a basic starter kit that caters for the beginner chemist
- 27BU caters for more experienced and advanced chemists

All of the apparatus found in both 29BU/M and 27BU sets share the same Quickfit® joint size 14/23. This greatly increases the versatility of the sets, since a wide variety of assemblies can be made up from a small number of components. They are the ideal choice where economy is an important consideration.

The sets are supplied in boxes designed to house all the parts safely in the minimum amount of space. This simplifies the problems of checking equipment as well as providing safe permanent storage.

## Set 29BU/M, organic chemistry kit, 14/23 joint size



- Starter kit - ideal for introducing students to principal techniques of preparative organic chemistry
- Comprises 5 glassware items all with size 14/23 Quickfit® ground-glass joints - giving maximum flexibility
- Scale based on starting material quantities up to 30g
- Both reflux and distillation assemblies can be constructed
- Housed in a robust cardboard box with foam rubber liner for product protection

Product Code	Description	Pack qty.
29BU/M	Complete set comprising 5 items of glassware as detailed in the table below	1

## Set 29BU/M, components

Product Code	Key	Description	Pack qty.
FP50/1	1	Pear shaped flask, 50ml	1
SH4/1	2	Stillhead	1
C1/11/SC	3	Liebig condenser	1
ST51/13	4	Screwcap adapter	1
RA1/11	5	Receiver adapter	1

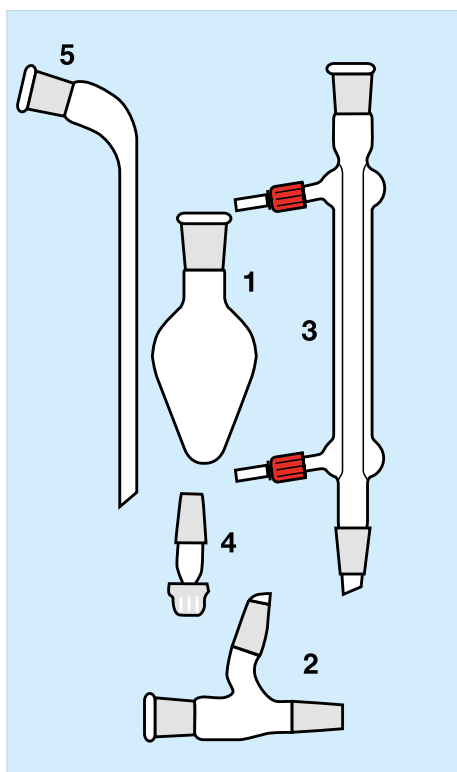

## Set 27BU, organic chemistry kit, 14/23 joint size



- The most popular Quickfit® set for schools, colleges and universities
- Comprises 9 basic items of Quickfit® glassware all with size 14/23 ground-glass joints for compatibility
- Allows the construction of at least 8 assemblies including steam distillation, reflux with addition and preparation
- Scale based on starting material quantities up to 30g
- Housed in a robust cardboard box with foam rubber liner to provide safe storage and transit
- Supplied with a CD-ROM which includes practical details of some typical assemblies

Product Code	Description	Pack qty.
27BU	Complete set comprising 9 items of glassware as detailed below	1

### Set 27BU, components

Product Code	Key	Description	Pack qty.
FP50/1	1	Pear shaped flask, 50ml	1
SH4/1	2	Stillhead	1
C1/11/SC	3	Liebig condenser	1
ST51/13	4	Screwcap adapter	1
RA1/11	5	Receiver adapter	1
MF5	6	Air leak/steam inlet tube	1
D1/11GP	7	Dropping funnel, 50ml, with GP Rotoflo tap	1
SB14	8	Stopper	1
60/110/10	9	Thermometer	1

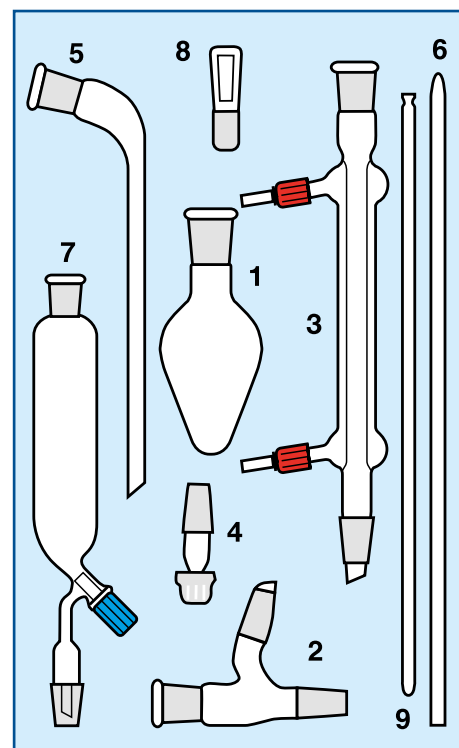

New



## Set ML1, microscale organic chemistry kit



- Designed for organic chemistry experiments using milligram quantities of reagents
- Comprises 12 items of glassware that all feature 14/10 joint sizes for compatibility
- All components utilise a combination of standard Quickfit® ground glass joints together with screwthread couplings, sealing 'O' rings and plastic screw caps
- The screwthread connector system eliminates the requirement for grease, saves on space, using clamps and vastly reduces the danger of glassware becoming loose during reactions
- Allows the construction of many assemblies including reflux, distillation, moisture sensitive reactions and fractional distillation
- Housed in a sturdy Grattells tray with protective foam insert

Product Code	Description	Pack qty.
ML1	Complete set comprising 12 items of glassware as detailed in the table below	1



*Kit supplied with bag of accessories - includes 5 x plastic caps, 5 x 'O' rings, 5 x sealing discs and 1 x thermometer accessories.*

## Set ML1, components

Product Code	Key	Description	Pack qty.
ML/C2	1	Air condenser	1
ML/C1	2	Jacketed condenser	1
ML/MF23	3	Drying tube	1
ML/SH4	4	Still head	1
ML/ST	5	Thermometer adapter	1
ML/RA3	6	Receiver	1
ML/FE10	7	10ml Erlenmeyer flask	1
ML/FE25	8	25ml Erlenmeyer flask	1
ML/FR10	9	10ml Round bottom flask	1
ML/FR25	10	25ml Round bottom flask	1
ML/FP10	11	10ml Pear shaped flask	1
ML/FP25	12	25ml Pear shaped flask	1
_____	13	Bag of spare caps, 'O' rings, sealing discs	1

## Set ML1, accessories and spares



- Compatible with ML1 microscale kit and microscale dropping funnel
- Microscale glass stopper has a 14/10 ground glass cone

Product Code	Description	Pack qty.
ML/STPR	Microscale glass stopper with 14/10 cone	5
ML/O13	'O' ring 13mm	1
ML/CAP13	Plastic cap 13mm	1
ML/O20	'O' ring 20mm	5
ML/CAP20	Plastic cap 20mm	5
ML/DISC20	Sealing disc	5



## Set ML1, microscale dropping funnel



- Designed for use with the ML1 microscale chemistry kit
- Interchangeable PTFE key stopcock
- Supplied complete with screwthread connector, 'O' ring and sealing disc
- Can be used in conjunction with microscale glass stopper

Product Code	Description	Pack qty.
ML/FUN	Dropping funnel	1







# Small wonder

The Quickfit® Microscale Chemistry Kit performs organic chemistry experiments, but on a much smaller scale.

- Save on reagents, disposal costs and clamping equipment.
- Smaller amounts of toxic chemicals means much safer handling.
- Designed to fit into any school or college laboratory.
- All 12 pieces made from Quickfit® ground glass joints and Pyrex® borosilicate glass.



PYREX® is a registered trademark of Corning Inc.

## Slide staining kit



- Convenient kit for slide staining, storage and transportation
- Comprises three separate components to be purchased individually

### Black polyacetal trough (SWM016)

- Dimensions - 100 x 85 x 55mm deep
- Supplied complete with a push-fit lid and small adapter to aid drainage

### Black polyacetal rack (SWM018)

- Has a folding handle for transfer and immersion of slides
- Slotted and numbered for 25 slides
- Fits snugly into the trough whilst the folding handle permits closure of the trough lid during staining

### Black polystyrene storage box (SWM020)

- Dimensions - 190 x 170 x 38mm
- Complete with push-fit lid
- Designed to accommodate four of the above racks
- The lid closes tightly with the rack handles down
- Has numbered index sheets for reference
- The box with four racks can be used to store or transport up to 100 slides



*Polyacetal is resistant to alcohol although it is not suitable for phenol.*

Product Code	Description	Pack qty.
SWM016	Trough	1
SWM018	Rack	1
SWM020	Storage box	1

## Slide staining jar



- Robust polypropylene jar
- Can hold 10 slides back to back
- Design conserves space and staining solution
- Useful for staining, biochemical tests, small batches or for mailing of slides

Product Code	Base O.D. (mm)	Cap O.D. (mm)	Height (mm)	Pack qty.
SWM012	33	46	83	1



# Spatulas, spotting tiles, stands



## Spatulas, polypropylene



- Moulded strong tapered spatulas with chamfered ends
- Virtually unbreakable in normal use and retain shape after flexing
- Good chemical and heat resistance
- Autoclavable at 121°C

Product Code	Length (mm)	Pack qty.
SWY060P	115	10
SWY062P	165	10
SWY064P	200	10
SWY066P	245	10



## Spotting tile, polypropylene



- High quality spotting tile, unbreakable in normal use
- 12 cavities of approximately 1ml capacity
- Economical alternative to ceramics
- 4mm well depth

Product Code	Dimensions (mm)	Pack qty.
TWR000P	115 x 95	10



## Stand, petri dish, coated



- Holds up to six 90mm petri dishes
- Manufactured from polyamide epoxy coated steel
- Offers a better heat and chemical resistance than other coatings
- Ideal for small batch incubation

Product Code	Pack qty.
SWP062	1

## Stand, retort, weighted, polyethylene



- Weighs 2.5kg ensuring stability
- Corrosion resistant
- Polyethylene coated metal rod screws into the base
- Available with the hole in the centre or at the short edge

Product Code	Base w x l x h (mm)	Rod position	Rod h x O.D. (mm)	Pack qty.
SWP012	171 x 248 x 52	Centre	12.5 x 760	1
SWP014	171 x 248 x 52	Edge	12.5 x 760	1

 A range of burette clamps are featured on page 97



## Stirring bars, magnetic, PTFE



- For the stirring of liquids on magnetic stirrers and hot plate stirrers
- Strong alloy magnets sheathed in pure white inert PTFE
- Supplied in polarity aligned packs to ensure maximum coupling strength
- Resistant to virtually all chemical attack and temperatures up to 260°C

## Stirrer bars, magnetic, cross-head, PTFE

- For efficient stirring in tube-like containers and effective as general stirrers
- Items SWN920, SWN925, SWN 926 and SWN927 are single sided. All other items in this range are double sided.

Product Code	Diam. x height (mm)	Pack qty.
SWN920	10 x 8	2
SWN925	25 x 15	2
SWN926	40 x 17	2
SWN927	60 x 17	2
SWN930	10 x 8	2
SWN931	14 x 10	2
SWN933	22 x 15	2
SWN934	30 x 12	2
SWN935	40 x 14	2
SWN936	60 x 15	2



# Stirrer bars



## Stirrer bars, magnetic, cylindrical, PTFE



- Plain design with rounded ends, suitable for a wide range of flat bottomed containers

Product Code	Length (mm)	O.D. (mm)	Pack qty.
SWN652	6	3	2
SWN654	8	3	2
SWN656	12	4.5	2
SWN657	13	6	2 <b>NEW</b>
SWN658	15	4.5	2
SWN660	20	6	2
SWN662	25	6	2
SWN664	30	6	2
SWN666	35	6	2
SWN6620	25	8	2 <b>NEW</b>
SWN668	40	8	2
SWN670	45	8	2
SWN672	50	8	2
SWN674	60	9	2
SWN676	70	9.5	2
SWN678	80	9.5	2

**New**



## Stirrer bars, magnetic, disk, PTFE



- Ideal for use in general stirring applications and in tubes

Product Code	Diam. x height (mm)	Pack qty.
SWN718	10 x 6	2
SWN722	30 x 12	2

### Stirrer bars, magnetic, micro, PTFE



- For use in small vessels, e.g. test tubes, vials etc.

Product Code	Length (mm)	O.D. (mm)	Pack qty.
SWN950	7	2	2
SWN952	8	1.5	2
SWN954	10	3	2
SWN956	13	3	2



### Stirrer bars, magnetic, octagonal, PTFE



- With central pivot ring
- Shape gives increased turbulence at low speeds

Product Code	Length (mm)	O.D. (mm)	Pack qty.
SWN708	13	8	2
SWN700	15	8	2 <b>NEW</b>
SWN710	25	8	2
SWN712	38	8	2
SWN7140	51	8	2 <b>NEW</b>
SWN7010	38	10	2 <b>NEW</b>
SWN714	51	10	2
SWN715	64	10	2 <b>NEW</b>
SWN716	75	12	2



### Stirrer bars, magnetic, oval, PTFE



- For efficient stirring in round bottomed flasks

Product Code	Length (mm)	O.D. (mm)	Pack qty.
SWN520	20	10	2
SWN522	25	12	2
SWN524	30	16	2
SWN525	35	16	2
SWN526	40	20	2
SWN528	50	20	2



# Stirrer bars

New



## Stirrer bars, magnetic, plain, PTFE



- Similar to cylindrical stirrer bars but give greater turbulence at low speed
- Ideal for use with large vessels

Product Code	Length (mm)	O.D. (mm)	Pack qty.
SWN677	75	13	2
SWN680	108	27	2
SWN682	159	27	2



## Stirrer bars, magnetic, pivot ring, PTFE



- Central pivot ring ensures efficient spinning even on curved or uneven bases

Product Code	Length (mm)	O.D. (mm)	Pack qty.
SWN500	8	3	2
SWN501	15	4.5	2
SWN502	12	4.5	2
SWN503	20	6	2
SWN504	25	6	2
SWN505	35	6	2
SWN506	45	8	2
SWN507	40	8	2
SWN508	60	9.5	2
SWN509	50	8	2
SWN510	70	9.5	2
SWN511	30	6	2



## Stirrer Bars, magnetic, triangular, PTFE



- Spins well giving the best possible mixing action
- Ideal for mixing difficult solutions e.g. dissolving in solvents or mixing sediments

Product Code	Length (mm)	O.D. (mm)	Pack qty.
SWN532	12	6	2
SWN534	25	8	2
SWN536	35	9	2
SWN538	50	12	2

## Stirrer bars, magnetic, turbo, PTFE



- Turbo stirrer bars have increased magnetic strength compared to Alnico magnets and are resistant to demagnetisation
- Turbo bars are identifiable by a carbon black spot

Product Code	Length (mm)	O.D. (mm)	Pack qty.
SWN606	25	14	1
SWN608	50	24	1
SWN610	70	28	1

 Turbo stirrer bars contain a powerful samarium-cobalt magnet. The powerful attraction to the drive magnet may give rise to the release of PTFE particles caused by abrasion between the stirrer and the container base.



## Stirrer bars, magnetic, turbo block, PTFE



- For very effective stirring especially of viscous fluids
- Twin turbo magnets inserted into a solid PTFE body

Product Code	Dimensions (h x l x w) (mm)	Pack qty.
SWN1003	14 x 40 x 34	1
SWN1004	18 x 55 x 44	1
SWN1005	30 x 90 x 80	1

 Turbo stirrer bars contain a powerful samarium-cobalt magnet. The powerful attraction to the drive magnet may give rise to the release of PTFE particles caused by abrasion between the stirrer and the container base.



## Stirrer bars, magnetic, set, PTFE



- Useful assortment of the most popular types and sizes of PTFE magnetic stirrer bars
- Supplied in a red polypropylene compartmented box with opaque natural lid
- Contains:
  - Pivot ring: two each of 12 x 4.5 25 x 6 45 x 8 and 60 x 9.5mm
  - Oval: two each of 20 x 10, 25 x 12, 35 x 16 and 50 x 20mm
  - Micro: three each of 7 x 2 and 10 x 3mm

Product Code	Description	Pack qty.
SWN515	Set of 22 PTFE stirrer bars	1

 Stirring bars only are autoclavable. (Do not autoclave in box)





# Stirrer bars

New



## Stirrer bars, magnetic, cylindrical, set, PTFE



- Useful assortment of popular sizes of PTFE cylindrical magnetic stirrer bars
- Supplied in a clear compartmented lidded box
- Contains:
  - Two each of 10 x 6, 15 x 4.5, 20 x 6, 25 x 6, 30 x 6mm
  - 40 x 8, 50 x 8, 60 x 10 and 70 x 10mm bars

Product Code	Description	Pack qty.
SWNBOX3019	Set of 18 cylindrical PTFE stirrer bars	1

 *Stirring bars only are autoclavable. (Do not autoclave in box)*

New



## Stirrer bars, magnetic, cylindrical and removable ring, set, PTFE



- Useful assortment of popular sizes of PTFE cylindrical and removable ring magnetic stirrer bars
- Supplied in a clear compartmented lidded box
- Contains:
  - Cylindrical: Two each of 13 x 10, 13 x 8, 20 x 8, and four of 25 x 8mm
  - Removable ring: Two each of 32 x 8 and 38 x 8, one of 38 x 10, three of 42 x 10, and two of each of 51 x 8 and 51 x 10mm

Product Code	Description	Pack qty.
SWNBOX3020	Set of 22 cylindrical and removable ring PTFE stirrer bars	1

 *Stirring bars only are autoclavable. (Do not autoclave in box)*

## Stirrer bar, retrievers, PTFE coated



- Magnet permanently embedded in PTFE rod
- Ideal for retrieving magnetic stirrer bars from particularly sensitive or corrosive liquids
- Turbo retrievers are ideal for use with turbo stirrer bars

Product Code	Description	Length (mm)	O.D. (mm)	Pack qty.	
SWN564	Standard	250	10	1	
SWN566	Standard	350	10	1	
SWN1013	Turbo	350	10	1	<b>NEW</b>
SWN1016	Turbo	450	18	1	<b>NEW</b>



## Stirrer shaft, anchor



- Designed for low speed operation
- Ideal for use with Quickfit® wide-neck reaction flasks FR:F series
- Paddle closely follows the contour of the flask walls
- Useful where the build-up of solid material on the walls is likely
- The minimum neck size required for the stirrer is 100mm

Product Code	Approx shaft diam. (mm)	Approx shaft length (mm)	Blade width (mm)	Pack qty.
ST1/5	6	450	90	1
ST1/6	6	600	135	1
ST1/8	11	750	135	1



Paddle ST1/5 is suitable for use with Quickfit® reaction flasks FR700F and FR1LF. Paddles ST1/6 and ST1/8 are for larger capacity vessels. Reaction flasks are detailed on page 159.



# Stirrers



**i** These PTFE bladed stirrers may be used at temperatures up to 250°C.



**New**



## Stirrer, PTFE blade



- PTFE construction for maximum resistance to chemical attack
- PTFE blades can be pivoted on the glass shaft to allow passage through small apertures e.g. necks and sockets of Quickfit® flasks
- Blades are detachable for cleaning and replacement purposes
- Useful for sweeping close to the vessel walls as they will not cause scratching
- For use with glass stirrer shaft detailed below

Product Code	Blade width (mm)	Min. neck size for stirrer	Pack qty.
ST7/2	52	19/26 Socket	5
ST7/3	76	24/29 Socket	5
ST7/3L	76	24/29 Socket	5

## Stirrer shaft for PTFE blade

- Pyrex® borosilicate glass construction
- For use with ST7: series PTFE blades

Product Code	To fit PTFE blade	Approx shaft diam. (mm)	Approx shaft length (mm)	Pack qty.
ST6/7	ST7/2 & ST7/3	6	450	1
ST11/5	ST7/3L	11	750	1

## Stirrer shaft, fixed paddle



- Ideal for use with large capacity flasks or Quickfit® wide-neck reaction vessels
- Design of pitched paddle helps to reduce the overall power consumption

Product Code	Approx shaft diam. (mm)	Approx shaft length (mm)	Min. neck size for stirrer	Blade width (mm)	Pack qty.
ST1/2	6	610	55/44 Socket	50	1

## Stirrer shaft, for blades, PTFE



- PTFE construction for maximum resistance to chemical attack
- PTFE blades can be pivoted on the stirrer shaft to allow passage through small apertures e.g. necks and sockets of Quickfit® flasks
- For use with PTFE stirrer blades and PTFE universal stirrer guides

Product Code	Approx shaft diam. (mm)	Approx shaft length (mm)	Pack qty.
SWN750	6	400	1
SWN752	6	500	1
SWN754	10	550	1
SWN756	10	650	1

## Stirrer shaft, anchor, PTFE



- Designed for low speed operation
- Paddle closely follows the contour of the flask walls
- Useful where the build-up of solid material on the walls is likely

Product Code	Approx shaft diam. (mm)	Approx shaft length (mm)	Blade width (mm)	Pack qty.
SWN556	6	400	80	1
SWN5560	6	500	80	1
SWN557	10	550	100	1
SWN5570	10	650	100	1
SWN5580	10	650	140	1

 Suitable for use with universal stirrer guides



## Stirrer, blade, plain end, PTFE



- PTFE blades can be pivoted on the stirrer shaft to allow passage through small apertures e.g. necks and sockets of Quickfit® flasks
- Blades are detachable for cleaning and replacement purposes
- Useful for sweeping close to the vessel walls as they will not cause scratching
- For use with PTFE and glass stirrer shafts

Product Code	Blade length (mm)	Min. neck size for stirrer	Pack qty.
SWN730	65	29/32	5
SWN732	75	29/32	5
SWN734	105	29/32	5
SWN736	125	29/32	5
SWN738	150	29/32	5



## Stirrer shaft, centrifugal, PTFE



- Strirer blades fold in for ease of access through necks of vessels and out during use

Product Code	Approx shaft diam. (mm)	Approx shaft length (mm)	Blade width (mm)	Pack qty.
SWN559	6	400	50	1
SWN5590	6	500	50	1
SWN560	10	550	70	1
SWN5600	10	650	70	1

 Suitable for use with universal stirrer guides



# Stirrers

New

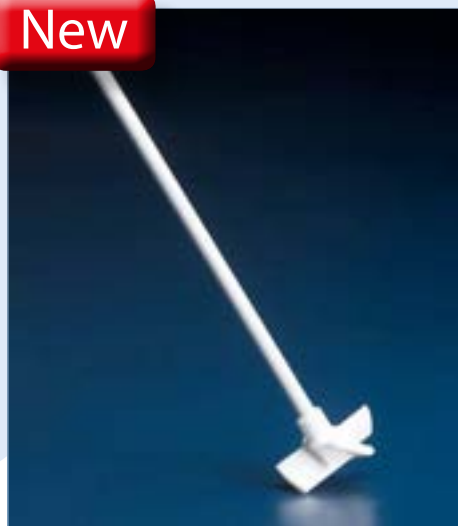

## Stirrer shaft, screw propellers, PTFE



- Propeller design produces very effective mixing

Product Code	Approx shaft diam. (mm)	Approx shaft length (mm)	Blade width (mm)	Pack qty.
SWN5540	6	500	50	1
SWN5550	10	650	60	1

 Suitable for use with universal stirrer guides



## Stirrer guides



- Designed to reduce excessive 'whip' in glass stirrer shafts which can lead to breakage
- A PTFE bearing is fitted to the bottom of guides ST2/33C/SC and ST2/44C/SC for additional support
- Features a side-arm with detachable plastic connector for the introduction of gases or connection to a vacuum supply

Product Code	To fit stirrer shaft (mm)	Socket size	Cone size	Approx. stem length (mm)	Pack qty.
ST2/2/SC	6	19/26	19/26	200	1
ST2/33C/SC	11	24/29	24/29	300	1
ST2/44C/SC	11	29/32	29/32	300	1

 Spare PTFE bearings are available - Item code ST2C.

New



## Stirrer guides, universal, PTFE



- Fits standard taper ground glass B joints and suitable for use with PTFE, glass or metal stirrer shafts
- Excellent chemical resistance
- No shedding
- Maximum recommended speeds; 500rpm continuous, 800rpm intermittent
- Reduces vibration and whip
- Vacuum to 5mm Hg and pressure to 3-5 psi

Product Code	To fit stirrer shaft (mm)	Cone size	Pack qty.
SWN761	6	19/26	1
SWN762	6	24/29	1
SWN765	10	24/29	1
SWN766	10	29/32	1
SWN768	10	34/35	1

## Stirrer glands, glass



- Used for introducing stirrer paddles into Quickfit® flasks and vessels
- Provides a vapour-tight seal between paddle and flask
- Holds a vacuum down to 0.1 torr (13.3Pa)
- Comprises parallel ground glass sleeve with cup to accept a suitable lubricant (see notes)
- Supplied complete with screwcaps rubber rings and PTFE washers

Product Code	To fit stirrer shaft (mm)	Cone size	Thread size (mm)	Pack qty.
ST20/2	6	19/26	13	1
ST20/3	11	24/29	24	1
ST20/4	11	29/32	24	1

### Instructions for use

**Lubricant:** The lubricant may be any relatively non-volatile compound suitable for use with the reaction in hand, provided its viscosity does not exceed that of glycerol. Typical lubricants are spindle oil and liquid paraffin.

**Speed:** The stirrer should not be run at speeds in excess of 700rpm. When lubricants of high viscosity are used, rotation should commence at approximately 100rpm and should be gradually increased to maximum speed over 10 minutes.

**Assembly:** Attach the stirrer to the sleeve of the gland by tightening the plastic screwcap. The gland will be damaged if rotated when dry and the ground surfaces must be smeared with lubricant before assembly. Care must be taken to ensure that the ground surfaces are clean and free from dust or grit before use.



## Stirrer glands, PTFE



- 'Stuffing box' glands available with either brass or PTFE cones
- Provides a seal to a stirrer shaft by the adjustable compression of rubber 'O' rings and felt washers impregnated with lubricant
- Glands ST4/2 and ST4/2F have integral drive pulleys

Product Code	Description	Material (cone portion)	To fit stirrer shaft (mm)	Pulley diam. (mm)	Cone size	Pack qty.
ST4/2	Gland with pulley	Brass	6	35	19/26	1
ST4/2F	Gland with pulley	PTFE	6	23	19/26	1
ST3/2F	Gland only	PTFE	6	35	19/26	1

### Spares for PTFE stirrer glands

Product Code	Description	Pack qty.
ST4R	Spare 'O' ring	10
ST4W	Spare feltwasher	10



# Stirring rods



## Rods, stirring, glass

**MBL®**

- Borosilicate glass rods for general stirring applications
- With rounded ends for extra safety and to minimise scratching

Product Code	Diam. (mm)	Length (mm)	Pack qty.
SRF380	6	300	10



*When stirring, avoid the end of the rod abrading the inner surface of glass vessels. Scratches seriously impairs the strength of glassware and affected items should not be used.*



## Rods, stirring, glass, double ended

**MBL®**

- Manufactured from borosilicate glass rod
- With rounded button and paddle ends
- Button end is useful for crushing clumped powder and solids
- Paddle end helps to circulate sediment when stirring

Product Code	Diam. (mm)	Length (mm)	Pack qty.
SRF384	6	200	10
SRF386	6	300	10



*When stirring, avoid the end of the rod abrading the inner surface of glass vessels. Scratches seriously impairs the strength of glassware and affected items should not be used.*



## Rods, stirring, PTFE coated



- Suitable for stirring even the most corrosive liquids
- Will withstand 260°C
- PTFE covered with plain ends
- 6mm diameter

Product Code	Length (mm)	Pack qty.
SWN542	150	1
SWN544	200	1
SWN546	250	1
SWN548	300	1
SWN550	350	1
SWN552	400	1

## Rotaflo® Stopcocks

- The following pages show a range of glass/PTFE stopcocks for the discerning glassblower
- Designs that are proven to give great performance
- High performance (HP) Rotaflo® stopcocks for very demanding applications and high vacuum work
- Each stopcock individually tested for  $10^{-9}$  Torr vacuum performance
- General purpose (GP) Rotaflo® stopcocks for general laboratory usage offering fine flow control and greaseless, trouble-free performance



## ROTAFLO®

### High performance (HP) Rotaflo stopcocks

High performance Rotaflo® vacuum stopcock providing many significant benefits to the user:

- Borosilicate glass with PTFE key for excellent chemical resistance
- No lubrication required - no seizure and no contamination
- Temperature range from  $-20^{\circ}\text{C}$  to  $200^{\circ}\text{C}$
- Operates over a pressure range of +1bar to  $10^{-9}$  Torr
- Individually tested by mass spectrometer and supplied with certificate for guaranteed performance
- Locking ring to prevent accidental removal of the key
- Fully interchangeable keys
- Ergonomic key for good grip and easy operation



### HP Rotaflo®, plain side-arms, straight pattern

### ROTAFLO®

Product Code	Key bore (mm)	Sidearm bore (mm)	Sidearm O.D. (mm)	Approx overall length (mm)	Pack qty.
HP3ST/5	3.0	5	8	210	1
HP3ST/7	3.0	7	10	210	1
HP6ST/7	6.0	7	10	210	1
HP6ST/10	6.0	10	13	210	1
HP10ST/10	10.0	10	13	225	1



Side-arms are 100mm in length.





# Stopcocks



## HP Rotaflo®, plain side-arms, right angle pattern

ROTAFLO®

Product Code	Key bore (mm)	Sidearm bore (mm)	Sidearm O.D. (mm)	Approx overall length (mm)	Pack qty.
HP3RA/5	3.0	5	8	210	1
HP3RA/7	3.0	7	10	210	1
HP6RA/7	6.0	7	10	210	1
HP6RA/10	6.0	10	13	210	1
HP10RA/10	10.0	10	13	225	1



Side-arms are 100mm in length.



## HP Rotaflo®, three way stopcock

ROTAFLO®

Product Code	Key bore (mm)	Sidearm bore (mm)	Sidearm O.D. (mm)	Approx overall length (mm)	Pack qty.
HP3TW/5	3.0	5	8	215	1
HP6TW/7	6.0	7	10	220	1



All HP Rotaflo® stopcocks are individually tested for 10<sup>-9</sup> Torr vacuum performance and supplied with test certificate.



## HP Rotaflo®, stopcock spare parts

ROTAFLO®

- Replacement keys and locking rings should be ordered separately

Product Code	Description	Bore (mm)	Pack qty.
HP3K	Replacement key	3.0	2
LR3	Locking rings	3.0	5
HP6K	Replacement key	6.0	2
LR6	Locking rings	6.0	5
HP10K	Replacement key	10.0	1
LR10	Locking rings	10.0	5

### GP Rotaflo<sup>®</sup>, plain side-arms, straight pattern

ROTAFLO<sup>®</sup>

- Rotary design for fine single drop control; invaluable on burettes
- Borosilicate glass with PTFE key for excellent chemical resistance
- No lubrication required - no seizure and no contamination
- Temperature range -20°C to 200°C
- Vacuum capability to 10<sup>-4</sup> Torr
- Increased barrel diameter for excellent drainage
- Locking ring to prevent accidental removal
- Ergonomic key for good grip and easy operation

Product Code	Key bore (mm)	Sidearm bore (mm)	Sidearm O.D. (mm)	Approx overall length (mm)	Pack qty.
GP3ST/5	3.0	5	8	210	5
GP6ST/7	6.0	7	10	210	5
GP10ST/10	10.0	10	13	225	2



Side-arms are 100mm in length.

### GP Rotaflo<sup>®</sup>, plain side-arms, right angle pattern

ROTAFLO<sup>®</sup>

Product Code	Key bore (mm)	Sidearm bore (mm)	Sidearm O.D. (mm)	Approx overall length (mm)	Pack qty.
GP3RA/5	3.0	5	8	150	5
GP6RA/7	6.0	7	10	165	5
GP10RA/10	10.0	10	13	175	2



Side-arms are 100mm in length.

### GP Rotaflo<sup>®</sup>, Burette repair stopcock

ROTAFLO<sup>®</sup>

- With one plain sidearm and one capillary arm drawn to a jet for the repair of burettes

Product Code	Key bore (mm)	Sidearm bore (mm)	Sidearm O.D. (mm)	Approx overall length (mm)	Pack qty.
GP3BU/5B	3.0	9	12	175	5



# Stopcocks



## GP Rotaflo®, Stopcock spare parts

ROTAFLO®

- Replacement keys and locking rings should be ordered separately

Product Code	Description	Key bore (mm)	Pack qty.
GP3K	Replacement key	3.0	5
LR3	Locking rings	3.0	5
GP6K	Replacement key	6.0	5
LR6	Locking rings	6.0	5
GP10K	Replacement key	10.0	5
LR10	Locking rings	10.0	5



## Stopcocks, plain arms, straight bore, PTFE key

PYREX®

- Manufactured from borosilicate glass with PTFE keys for highest resistance to chemical attack
- Barrels are highly polished and the keys are self lubricating, avoiding the need for stopcock grease
- Keys are fully interchangeable and supplied complete with plastic screw thread retaining device
- Made to a taper of 1:10 giving a combination of performance and ease of operation

Product Code	Key bore (mm)	Stopcock diameter (mm)	Sidearm O.D. (mm)	Sidearm wall thickness (mm)	Pack qty.
SST102	1.5	12.5	8	1.0	5
SST103	2.5	14.5	10	1.0	5
SST104	4.0	14.5	10	1.0	5
SST106	6.0	18.8	12	1.0	5
SST108	8.0	24.0	14	1.5	5

 Spare PTFE keys are available on page 252.



## Stopcocks, plain arms, double bore, PTFE key

PYREX®

- Manufactured from borosilicate glass with PTFE keys for highest resistance to chemical attack
- Barrels are highly polished and the keys are self lubricating avoiding the need for stopcock grease
- Keys are fully interchangeable and supplied complete with a retaining device
- Made to a 1:10 taper, giving a combination of performance and ease of operation

Product Code	Key bore (mm)	Stopcock diameter (mm)	Sidearm O.D. (mm)	Sidearm wall thickness (mm)	Pack qty.
SST203	2.5	14.5	9	1.5	5



### Stopcocks, plain arms, T-bore, 3-way, PTFE key

**PYREX®**

Product Code	Key bore (mm)	Stopcock diameter (mm)	Sidearm O.D. (mm)	Sidearm wall thickness (mm)	Pack qty.
SST3025	2.5	14.5	9	1.5	5
SST304	4.0	18.8	10	1.5	5

 All side-arms are 100mm in length. Spare PTFE keys are available on page 252.



### Stopcocks, burette repair, straight bore, PTFE key or glass Key

**PYREX®**

Product Code	Key bore (mm)	Stopcock diameter (mm)	Key type	Plain arm O.D. x wall mm	Pack qty.
SST502	1.5	12.5	PTFE	8 x 1.5	5
SSD502	2.0	12.5	Glass	8 x 1.5	1

 One 100mm plain arm and one 70mm capillary arm with drawn jet. For spare keys, please refer to page 252 and 253.



### Stopcocks, funnel repair, straight bore, PTFE key

**PYREX®**

- With one flared end for connection to the base of the funnel and a 100mm long stem with angled tip

Product Code	Key bore (mm)	Stopcock diameter (mm)	Stem O.D. (mm)	Sidearm wall thickness (mm)	Pack qty.
SST702	1.5	12.5	10	2.2	5
SST703	2.5	14.5	10	2.2	5
SST704	4.0	18.8	10	2.2	5
SST706	6.0	18.8	14	2.5	5

 For spare PTFE keys, see page 252.

# Stopcocks



## Stopcocks, spare PTFE keys

**PYREX®**

- Fully interchangeable PTFE keys for Pyrex® stopcocks
- Supplied complete with plastic screw thread retaining device
- Keys are self lubricating, avoiding the need for stopcock grease
- Made to a taper of 1:10 giving a combination of performance and ease of operation

Product Code	Key type	Key bore (mm)	Stopcock diameter (mm)	Pack qty.
SST102K	Straight bore	1.5	12.5	5
SST1025K	Straight bore	2.5	12.5	5
SST103K	Straight bore	2.5	14.5	5
SST104K	Straight bore	4.0	14.5	5
SST105K	Straight bore	4.0	18.8	5
SST106K	Straight bore	6.0	18.8	5
SST203K	Double bore	2.5	14.5	5
SST303K	T-bore	2.5	18.8	5
SST304K	T-bore	4.0	18.8	5



## Stopcocks, plain arms, straight bore

**PYREX®**

- A range of glass stopcocks which meet the specifications of DIN 12541
- Manufactured from borosilicate glass with interchangeable key
- Leakage rate meets the requirements of DIN 12540 i.e. 0.1mbar l/s<sup>-1</sup>
- Supplied complete with key retaining device

Product Code	Key bore (mm)	Sidearm O.D. (mm)	Sidearm wall thickness (mm)	Pack qty.
SSD102	1.5	8	1.5	1
SSD103	2.5	9	1.5	1
SSD104	4.0	10	1.5	1



All side-arms are 100mm in length. See overleaf for spare glass keys.

## Stopcocks, spare glass keys

PYREX®

- Replacement keys for SSD: series stopcocks
- Manufactured from borosilicate glass
- Supplied complete with key retaining device

Product Code	Key type	Key bore (mm)	Stopcock diameter (mm)	Pack qty.
SSD102K	Straight bore	1.5	12.5	1
2392/22	Straight bore	2.5	12.5	1
SSD103K	Straight bore	2.5	14.5	1
SSD104K	Straight bore	4.0	14.5	1
2392/24	Straight bore	4.0	18.8	1
SSD106K	Straight bore	6.0	18.8	1



## Stopcocks, straight bore, high vacuum

PYREX®

- These stopcocks are specially designed and carefully manufactured for high vacuum applications
- Each stopcock tested for high vacuum performance.
- Borosilicate glass construction
- Keys and barrels are precision ground together in matched pairs for optimum performance
- Each key and barrel are numbered to ensure they are always paired together
- All side-arms are 100mm in length

Product Code	Key bore size (mm)	Sidearm O.D. (mm)	Sidearm wall thickness (mm)	Pack qty.
SSV103	3	9	1.5	1
SSV104	4	10	1.5	1
SSV106	6	11	1.5	1



## Stopcocks, double bore, high vacuum

PYREX®

Product Code	Key bore size (mm)	Sidearm O.D. (mm)	Sidearm wall thickness (mm)	Pack qty.
SSV202	2	8	1.5	1
SSV203	3	9	1.5	1
SSV204	4	10	1.5	1

 All side-arms are 100mm in length.



# Stopcocks



## Stopcocks, T-bore, 3-way, high vacuum

**PYREX®**

- Pyrex® borosilicate glass construction
- Each key and barrel are numbered to ensure they are always paired together
- All side-arms are 100mm in length

Product Code	Key bore size (mm)	Sidearm O.D. (mm)	Sidearm wall thickness (mm)	Pack qty.
SSV304	4	10	1.5	1



## Stopcocks, pump pattern, right angle, high vacuum

**PYREX®**

- Ideal for the connection of a vacuum line to a pump mounted at a lower level
- When the stopcock is closed the vacuum created by the pump holds the key securely in place

Product Code	Key bore size (mm)	Sidearm O.D. (mm)	Sidearm wall thickness (mm)	Pack qty.
SSV504	4	10	1.5	1

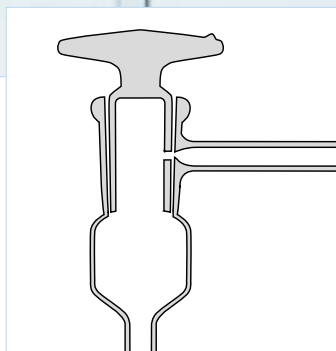

**i** All side-arms are 100mm in length.

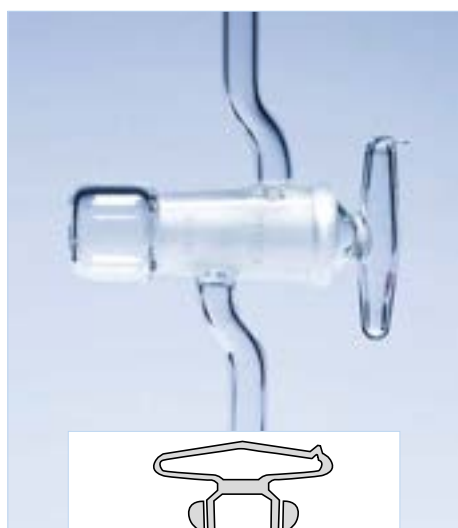

## Stopcocks, safety pattern, single-bore, high vacuum

**PYREX®**

- Designed to prevent accidental removal of the key whilst the system is under vacuum
- Open ended key features an extra bore 'B':
  - When connected to side-arm 'A' the bulb is evacuated thus holding the key firmly in place
  - Key cannot be removed until the vacuum is released

Product Code	Key bore size (mm)	Sidearm O.D. (mm)	Sidearm wall thickness (mm)	Pack qty.
SSV802	2	8	1.5	1
SSV804	4	10	1.5	1

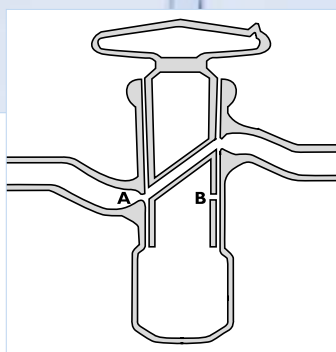

**i** All side-arms are 100mm in length.

### Stopcocks, rigid, polyethylene



- Efficient and easily turned stopcock
- 1/2" BSP screw fitting inlet
- Suitable for food contact applications in accordance with EU regulations

Product Code	Overall length (mm)	Bore I.D. (mm)	Outlet	Pack qty.
SWQ012	100	12	1/2" BSP	1



### Stopcocks, white polyethylene



- Efficient ball-valve stopcock
- 3/4" BSP thread
- Nominally 12mm bore, the outlet tapers to approximately 9mm O.D.

Product Code	Pack qty.
SWQ018	1



### Stopcocks, regulating taps, polypropylene

- Efficient polypropylene stopcocks
- Excellent chemical and temperature resistance

Product Code	Thread size BSP	Pack qty.
SWQ036	3/8"	1
SWQ038	1/2"	1
SWQ040	3/4"	1

 Remove rubber sealing ring prior to autoclaving.





# Stopcocks, stoppers

## Stopcocks, 2-way & 3-way, PVDF or Polyethylene



- Range of two and three way stopcocks in PVDF or polyethylene
- PVDF has excellent temperature, chemical and ageing resistance
- Polyethylene available for less stringent requirements

Product Code	Material	Type	For tube I.D. (mm)	Pack qty.
SWQ216	PVDF	2-way	10-11	1
SWQ218	PVDF	3-way	6-7	1
SWQ220	PVDF	3-way	8-9	1
SWQ224	PVDF	3-way	10-11	1
SWQ200	Polyethylene	2-way	6-7	1
SWQ202	Polyethylene	2-way	8-9	1
SWQ204	Polyethylene	2-way	10-11	1
SWQ206	Polyethylene	3-way	6-7	1
SWQ208	Polyethylene	3-way	8-9	1
SWQ210	Polyethylene	3-way	10-11	1



**i** Polyvinylidene fluoride (PVDF) can be used up to 150°C and has chemical resistance approaching that of PTFE.

## Stoppers, hollow-blown glass, 'B' length



- Ideally suited for use with Quickfit® jointed glassware and other glassware having standard ground glass sockets
- All Quickfit® stoppers conform to the standard tapers as outlined in ISO 383
- Borosilicate glass for chemical durability and high temperature performance
- Hollow-blown construction to reduce weight
- Hexagonal head prevents the stopper from rolling and provides a good grip
- Top of stopper is flat, allowing them to be stood on end and avoid contamination of the ground surface

Product Code	Cone size	Pack qty.
SB7	7/16	5
SB10	10/19	5
SB12	12/21	5
SB14	14/23	5
SB19	19/26	5
SB24	24/29	5
SB29	29/32	5
SB34	34/35	5
SB45	45/40	2



## Stoppers, hollow-blown glass, 'C' length



- Ideally suited for use with Quickfit® jointed glassware and other glassware having the shorter 'C' length ground glass sockets
- All Quickfit® stoppers conform to the standard tapers as outlined in ISO 383
- Borosilicate glass for chemical durability and high temperature performance
- Hollow-blown construction to reduce weight
- Hexagonal head prevents the stopper from rolling and provides a good grip
- Top of stopper is flat or slightly concave, allowing them to be stood on end and avoid contamination of the ground surface

Product Code	Cone size	Pack qty.
2595/01M	10/13	20
2595/02M	12/14	20
2595/03M	14/15	20
2595/05M	19/17	20
2595/06M	24/20	20
2595/07M	29/22	20



## Stoppers, hollow-blown glass, with drip tip



- Ideally suited for use with volumetric flasks etc.
- Lower closed end of stopper features a 'drip-tip' to ensure adhered liquid is returned to the flask
- Hexagonal head prevents the stopper from rolling and provides a good grip
- Flat head allows stopper to be stood on end, thus preventing contamination of the ground surface
- Hollow-blown to reduce weight

Product Code	Cone size	Pack qty.
TRF690	7/16	10
TRF691	10/19	10
TRF692	12/21	10
TRF693	14/23	10
TRF695	19/26	10
TRF696	24/29	10
TRF697	29/32	10
TRF698	34/35	5
TRF699	45/40	5



# Stoppers



## Stoppers, solid glass

**PYREX®**

- Ideally suited for use with Pyrex® bottles and aspirators
- Robust, solid glass construction
- Hexagonal head to provide a good grip

Product Code	Cone size	Head diam. (mm)	Overall height (mm)	Pack qty.
1522/02D	14/15	32	27	10
1522/04D	19/26	36	38	10
1522/05D	24/29	46	42	10
1522/06D	29/32	56	46	10
1522/10D	45/40	77	55	1
1522/12D	60/46	94	62	1



*The two largest sizes are semi-solid to reduce weight.*

**New**



## Stoppers, polyethylene



- Ideally suited for use with glass or plastic volumetric flasks and measuring cylinders etc. which have longer 'B' length sockets
- Manufactured from polyethylene
- Large head provides a good grip and gives protection if glassware is accidentally knocked over

Product Code	Cone size	Pack qty.
TRF591	10/19	10
TRF592	12/21	10
TRF593	14/23	10
TRF595	19/26	10
TRF596	24/29	10
TRF597	29/32	10
TRF598	34/35	10
TRF599	45/40	10



## SVL® Glassware

- SVL® glassware has screwthread joints which are easily connected together using purpose made couplings
- Only glass and PTFE come into contact with the chemicals being used to provide a grease-free and corrosion-resistant pathway
- Manufactured from Pyrex® borosilicate glass for maximum resistance to chemical attack and thermal shock
- Screwcaps and couplings in PBT or phenolic plastic for heat resistance up to 200°C
- Inserts and sealing rings with PTFE facings for maximum chemical resistance
- Can be assembled to provide sliding and rigid joints. Also positive closures
- No lubrication of joints required, hence no contaminating greases
- Joints and seals can be used under dynamic vacuum conditions. Typical performance  $10^{-3}$  mbar



## SVL® Connections

Versatile SVL® glassware allows three different types of joints and seals to be made quickly and easily.

### Butt Joint

A rigid butt joint can be made using two threaded tubes of the same diameter. They are connected via a special plastic coupling fitted with a sealing ring. The coupling is independently threaded on both sides to allow desired alignment of apparatus.

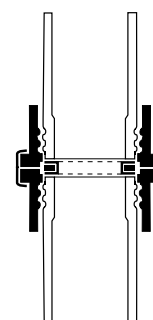

### Sliding Joint

Utilises a plastic screwcap having an aperture in the top for fittings to pass through. The latter is secured in position by compression of a sealing ring inside the cap.

All fittings are readily adjustable and the depth of immersion can be altered quickly by slackening the screwcap.

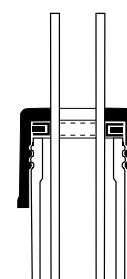

### Closure Seal

Utilises a plastic screwcap with a PTFE faced rubber insert. When screwed down onto the glass thread, it provides a closure which is highly resistant to chemical attack.

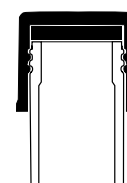



## Glass screwthreads

SVL®

- For use by Glassblowers to construct apparatus with SVL® joints
- Borosilicate glass for highest resistance to thermal shock and chemical corrosion

Product Code	SVL® joint size	Approx length (mm)	O.D. (mm)	Wall thickness (mm)	Pack qty.
703-01	15	165	16.0	1.8	10
703-02	22	165	22.5	1.8	10
703-03	30	165	32.0	2.0	10
703-04	42	165	44.1	3.2	10



SVL® glass screwthreads are designed specifically for use with SVL® screwcaps and couplings. They are not compatible with the Quickfit® range of screwcap fittings.



## Couplings for butt joints

SVL®

- Plastic coupling and sealing ring designed to secure two SVL® glass screwthreads of the same diameter in a butt joint
- Coupling is manufactured from PBT and consists of two separately threaded sections
- Sealing ring is manufactured from silicone rubber and sheathed with PTFE for protection against chemical attack. Internal diameter of the ring corresponds to the bore of the SVL® glass screwthread so that flow is not restricted
- Heat resistant up to 200°C

Product Code	SVL® joint size	Ring I.D. mm	Pack qty.
701-11	15	10	10
701-12	22	17	10
701-13	30	23	10
701-14	42	34	10

## Sealing rings for butt joints

SVL®

Product Code	SVL® joint size	Ring I.D. mm	Pack qty.
701-01	15	10	10
701-02	22	17	10
701-03	30	23	10
701-04	42	34	10

## Screwcaps, for sliding joints

**SVL®**

- PBT screwcaps (with hole) and sealing rings designed to provide a sliding joint
- Ideal for inserting thermometers and glass tubing etc. into an SVL® system
- Sealing rings manufactured from silicone rubber and sheathed with PTFE for protection against chemical attack
- Wide range of sizes for use with tubing from 4.0 to 32.8mm

Product Code	SVL® joint size	Pack qty.
701-41	15	10
701-42	22	10
701-43	30	10
701-44	42	10



*Screwcaps and rings should be ordered separately.*



## Sealing rings, for sliding joints

**SVL®**

Product Code	SVL® joint size	To accept tubing O.D. (mm)	Pack qty.
701-19	15	4.0 - 4.4	10
701-21	15	5.6 - 6.4	10
701-22	15	6.6 - 7.4	10
701-23	15	7.6 - 8.4	10
701-51	22	9.6 - 10.4	10
701-52	22	11.6 - 12.4	10
701-24	22	13.6 - 14.4	10
701-25	22	15.6 - 16.4	10
701-56	30	17.6 - 18.4	10
701-26	30	19.5 - 20.5	10
701-27	30	21.5 - 22.5	10
701-28	42	29.2 - 30.8	10
701-29	42	31.2 - 32.8	10

## Screwcaps, for positive closure

SVL®

- Designed to act as a positive closure when used with SVL® glass screwthreads
- Manufactured from PBT plastic with a PTFE faced rubber insert
- Can be autoclaved at 121°C
- Spare inserts available

Product Code	Description	Thread size (mm)	Pack qty.
4503/15	Cap with insert	SVL 15	20
4503/22	Cap with insert	SVL 22	20
4503/30	Cap with insert	SVL 30	20
4503/42	Cap with insert	SVL 42	10
4513/15M	Spare insert	SVL 15	20
4513/22M	Spare insert	SVL 22	20
4513/30M	Spare insert	SVL 30	20
4513/42M	Spare insert	SVL 42	10

## Adapter, cone/screwthread

SVL®

- Facilitates connection between SVL® and Quickfit® glassware
- Features an SVL® screwthread and Quickfit® ground glass cone
- Thread accepts SVL® screwcaps and couplings. Cone fits Quickfit® sockets
- Manufactured from temperature and chemical resistant borosilicate glass

Product Code	SVL® joint size	Cone size	Pack qty.
670-70	15	14/23	2
670-77	22	24/29	2
670-83	30	29/32	2

**i** Screwcap is not provided. Screwcap and adapter should be ordered separately.

## Adapter, socket/screwthread

SVL®

- Facilitates connection between SVL® and Quickfit® glassware
- Features an SVL® screwthread and Quickfit® ground glass socket
- Thread accepts SVL® screwcaps and couplings. Socket fits Quickfit® cones
- Manufactured from temperature and chemical resistant borosilicate glass

Product Code	SVL® joint size	Socket size	Pack qty.
670-00	15	14/23	2
670-03	22	24/29	2
670-05	30	29/32	2

**i** Screwcap not provided. Screwcap and adapter should be ordered separately.

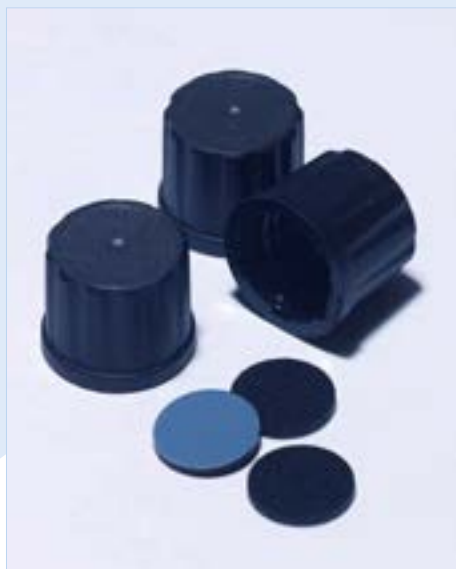

## Torion joints, glass bodies

**SVL®**

- Alternative jointing system for Glassblowers to make connections between tubing and glassware
- Only glass and PTFE come into contact with the liquid being used to provide a chemical resistant pathway
- Complete joint comprises borosilicate glass body, glass filled polypropylene fitting and rubber/PTFE sealing ring
- Glass body has an internal screwthread into which is fitted the rubber sealing ring sheathed with PTFE. Tubing is pushed through the screwthread fitting, which is then threaded onto the glass body. As the fitting is tightened, the sealing ring is compressed to form a seal between the tubing and the body

Product Code	Body height (mm)	Body max O.D. (mm)	Shank O.D. (mm)	Shank length (mm)	Pack qty.
721-01	27	21	14	8	10
721-02	32	26	17	9	10
721-03	42	37	25	15	10



721-01 supplied with 720-01 fitting and 701-20 sealing ring.  
 721-02 supplied with 720-02 fitting and 701-23 sealing ring.  
 721-03 supplied with 720-03 fitting and 701-24 sealing ring.  
 A further range of sealing rings for use with Torion joints are available below.  
 These can be used in place of the sealing ring provided to allow tubing of different diameters to be accommodated.



## Torion joints, spare sealing rings

**SVL®**

- Spare sealing rings for use with Torion joints to allow tubing of different diameters to be accommodated
- Manufactured from silicone rubber faced with PTFE to protect against chemical attack

Product Code	To suit glass body	To accept tubing O.D. (mm)	Pack qty.
701-19	721-02	4.0 - 4.4	10
701-20	721-01	4.8 - 5.2	10
701-21	721-02	5.6 - 6.4	10
701-22	721-02	6.6 - 7.4	10
701-23	721-02	7.6 - 8.4	10
701-24	721-03	13.6 - 14.4	10
701-25	721-03	15.6 - 16.4	10
701-51	721-03	9.6 - 10.4	10
701-52	721-03	11.6 - 12.4	10

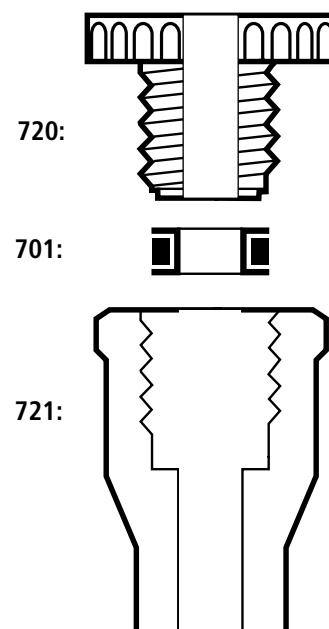



## Torion joints, spare fittings

SVL®

- For use with Torion glass bodies and rubber/PTFE sealing rings
- Fittings available in choice of materials
  - Glass filled polypropylene for use at temperatures up to 180°C
  - PTFE for use at temperatures up to 250°C

Product Code	Material	Bore (mm)	Pack qty.
720-01	Polypropylene	5.7	10
720-02	Polypropylene	8.7	10
720-03	Polypropylene	14.7	10
720-04	PTFE	5.7	10
720-05	PTFE	8.7	10
720-06	PTFE	14.7	10

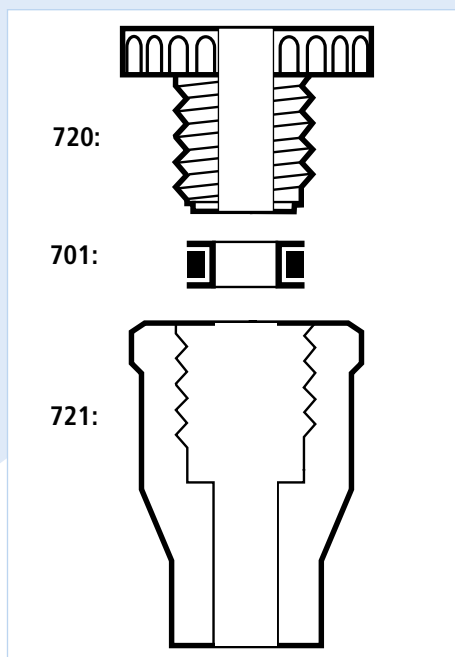

## Stirrer shafts

SVL®

- Designed for use with SVL® stirrer heads and stirrer bearings
- Manufactured from borosilicate glass
  - Lower end with internal screwthread to accept choice of stirrer heads
  - Upper section of shaft is ground to fit choice of stirrer bearings

Product Code	To fit SVL® reaction vessels cap. (ml)	Shaft length (mm)	Pack qty.
588-31	500	260	1
588-32	500, 1000	315	1
588-33	1000, 4000	405	1
588-34	4000, 6000, 10,000	490	1
588-35	20,000	580	1



*Diameter is approximately 10mm on the ground part of the shaft.*



## Stirrer heads

- Designed for use with SVL® stirrer shafts
- Head simply screws into the end of the shaft
- Manufactured from a PTFE based polymer with the Anchor and Helix types stiffened by a metal core

**SVL®**

Product Code	Type	Application	Diameter swept mm	Pack qty.
588-93	Collapsible blades	Vessels with SVL 30 joint or 29/32 socket	70	1
588-94	Paddle	SVL thermostatic reactors	70	1
588-95	Anchor	SVL reaction vessels	90	1
588-97	Helix-6 blades	SVL reaction vessels	80	1
588-98	Anchor	SVL reaction vessels	54	1



Stirrers must be rotated in a clockwise direction to prevent unscrewing of the thread.

## Stirrer bearings

- Designed to accept SVL® stirrer shafts with ground glass surfaces
- Borosilicate glass complete with fittings
- Glands manufactured from a PTFE based polymer which is self lubricating and corrosion-resistant
- Two types available:
  - With SVL® screwthread to allow connection to SVL® flasks
  - With Quickfit® ground glass cone to allow connection to Quickfit® flasks

**SVL®**

Product Code	Cone size	SVL thread size	Pack qty.
588-03	-	30	1
588-07	19/26	-	1
588-08	24/29	-	1
588-09	29/32	-	1
588-12	45/40	-	1



Bearings having an SVL® screwthread can be connected to SVL® reaction flasks via SVL® butt joints.

## Spare parts for stirrer bearing

- Range of spare parts enabling the user to replace worn components easily and economically

Product Code	Description	Pack qty.
588-00	Torion glass body (without glands)	1
588-92	Spare glands - complete set includes 3 bearings, 2 bushes, 1 spring, 1 washer, 1 screwhead fitting	1
588-99	Spare bearings	10



588-92

588-00

## Reaction vessels

SVL®

- Manufactured from borosilicate glass for high resistance to chemical attack and thermal shock
- With 100mm wide neck to accept SVL® lids and sealing ring

Product Code	Capacity (ml)	Body O.D. (mm)	Overall height (mm)	Shape	Pack qty.
296-54	500	115	120	Cylindrical	1
296-60	1000	115	200	Cylindrical	1
296-72	4000	206	245	Spherical	1
296-75	6000	235	280	Spherical	1
296-80	10000	279	325	Spherical	1
296-84	20000	345	410	Spherical	1

**i** Lids and sealing rings for use with these reaction vessels are detailed on page 267.

## Jacketed reaction vessel

SVL®

- Ideal for temperature controlled reactions
- With outer jacket through which a temperature controlling medium can be circulated (maximum temperature of 200°C)
- Contents of inner chamber can be run off via a Torion PTFE stopcock
- When used with an SVL® lid and PTFE covered sealing ring, the assembly is grease free and resistant to chemical attack

Product Code	Capacity (ml)	I.D. (mm)	Total depth (mm)	Depth of liner (mm)	Stopcock bore (mm)	Pack qty.
295-01	1000	100	245	195	8.0	1

**i** The thermostatic reaction vessel is supplied with the following components:  
 Two olive bends 14mm diameter X/34000695  
 Two bored caps 701-42  
 Three sealing rings 701-24  
 One PTFE stopcock plug 295-00  
 One screw threaded fitting 720-03

The following parts are required to assemble a complete reaction vessel:  
 One clamping system 295-02  
 One sealing ring 296-90  
 One SVL® lid 296-00/01/02/03

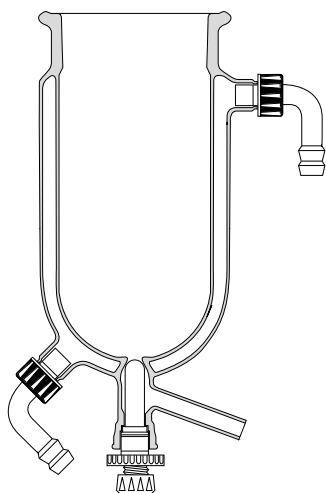

## Lids for reaction vessels

- For use with SVL® reaction vessels
- Borosilicate glass construction available in 3 styles:
  - Plain with knob (no necks) to act as a cover - 296-00
  - With two necks (one vertical central neck and one vertical side neck)
  - With five necks as shown in the table below

Product Code	SVL joint size central	SVL joint size vertical	SVL joint size vertical 2	SVL joint size angled	Overall height (mm)	Pack qty.
296-00	-	-	-	-	66	1
296-01	1 x 30	1 x 15	-	-	75	1
296-02	1 x 30	1 x 22	1 x 22	2 x 22	100	1
296-03	1 x 30	1 x 30	1 x 30	2 x 30	100	1

**i** Any SVL® neck will accept SVL® accessories via the use of either butt or sliding joints. Unused necks may be closed with screwcaps. Lids require the use of sealing ring item code 296-90 and quick release clamp item code 295-02 to effect good fit to reaction vessels. All SVL® reaction vessel lids have an internal diameter of 100mm.

# SVL®

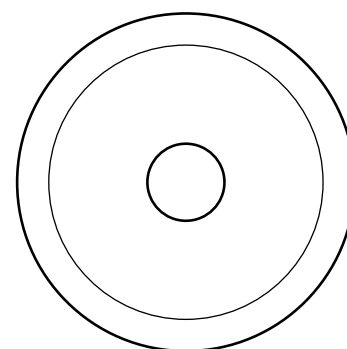

## Sealing ring, for reaction vessels

- For fitting between the flanges of SVL® reaction vessels and lids
- Silicone rubber sheathed with PTFE to provide a chemically resistant and grease free seal

Product Code	Description	Pack qty.
296-90	Sealing ring	1

# SVL®



New



### Quick release clamp, for reaction vessels and lids

SVL®

- For securing SVL® lids to reaction vessels
- One piece construction
- Manufactured from stainless steel
- Can be secured and removed in a single movement with an adjustable locking tab

Product Code	Description	Pack qty.
295-02	Quick release clamp for 100mm flange (complete)	1

### Torion stopcocks, straight pattern

SVL®

- Manufactured from borosilicate glass
- Utilises a Torion joint consisting of a Torion connector, silicone rubber sealing faced with PTFE and a PTFE key
- Vacuum capability to  $10^{-2}$  Torr
- Sidearms are 70 mm in length

Product Code	Key bore (mm)	Sidearm bore (mm)	Sidearm O.D. (mm)	Pack qty.
722-51	5.7	3	8	1
722-52	8.7	5	8	1
722-53	14.7	10	14	1

**i** 722-51 supplied with 720-01 fitting, 701-20 sealing ring and 720-51 PTFE key.  
722-52 supplied with 720-02 fitting, 701-22 sealing ring and 720-52 PTFE key.  
722-53 supplied with 720-03 fitting, 701-24 sealing ring and 720-53 PTFE key.

### Torion stopcocks, right angle pattern

SVL®

- Manufactured from borosilicate glass
- PTFE key is screwed into the threaded Torion connector, to open and close the stopcock
- No lubrication required - no seizure and no contamination
- Vacuum capability to  $10^{-2}$  Torr
- Sidearms are 70 mm in length

Product Code	Key bore (mm)	Sidearm bore (mm)	Sidearm O.D. (mm)	Pack qty.
722-41	5.7	3	8	1
722-42	8.7	5	8	1
722-43	14.7	10	14	1

**i** 722-41 supplied with 720-01 fitting, 701-20 sealing ring and 720-51 PTFE key.  
722-42 supplied with 720-02 fitting, 701-22 sealing ring and 720-52 PTFE key.  
722-43 supplied with 720-03 fitting, 701-24 sealing ring and 720-53 PTFE key.

## Thermometers, blue spirit filled, white back, partial immersion

### MBL®

- Mercury free - filled with safe low toxicity blue indicating fluid
- Calibrated for 'partial immersion' i.e. to give accurate readings when the thermometer is immersed to a specific depth (76mm as marked on thermometer)
- Graduations in permanent amber stain
- White coloured background provides clear observation of blue coloured liquid column
- Reinforced bulb to allow stirring
- With plastic non-roll top and safety suspension ring
- Nominal length 305mm
- Items 60/210/10 and 60/260/10 have a length of 405mm
- Item 60/330/20 has a brown spirit filling



Product Code	Range (°C)	Grads. (°C)	Tol. (±°C)	Pack qty.
60/050/05	-10 to 50	0.5	0.5	10
60/110/10	-10 to 110	1.0	1.5	10
60/150/10	-20 to 150	1.0	2.0	10
60/210/10	-10 to 210	1.0	3.0	10
60/260/10	-10 to 260	1.0	3.0	10
60/330/20	-10 to 330	2.0	6.0	10

## Thermometers, spirit filled, white back, total immersion

### MBL®

- Mercury free - filled with a low toxicity blue or green spirit
- Calibrated for 'total immersion'
- Permanent amber stain graduations
- White coloured background provides clear observation of coloured liquid column
- Reinforced bulb for stirring
- With plastic non-roll top and safety suspension ring
- Nominal length 305mm with item 30/210/10 length 405mm



Product Code	Range (°C)	Grads. (°C)	Tol. (±°C)	Colour	Pack qty.	
30/050/05	-10 to 50	0.5	0.5	Blue	10	
30/110/05	-20 to 110	0.5	0.5	Blue	10	<b>NEW</b>
30/110/10	-20 to 110	1.0	1.0	Blue	10	
30/150/10	-20 to 150	1.0	1.5	Blue	10	
30/210/10	-10 to 210	1.0	2.0	Blue	10	
30/250/10	-10 to 250	1.0	2.0	Green	10	<b>NEW</b>
30/300/10	-10 to 300	1.0	3.0	Green	10	<b>NEW</b>
30/360/10	-10 to 360	1.0	4.0	Green	10	<b>NEW</b>



If a 'total immersion' thermometer is used with a portion of the spirit column above the liquid level, a correction to the observed reading may be required.

# Thermometers



## Thermometers, low temperature, red spirit filled, white back, total immersion

**MBL®**

- Mercury free - filled with safe, red, low toxicity fluid
- White background provides clear observation of red coloured liquid column
- Calibrated for 'total immersion' i.e. to give accurate readings when the top of the spirit column is level with the liquid level
- 305mm in length

Product Code	Range (°C)	Grads. (°C)	Tol. (±°C)	Pack qty.
10/050/10	-100 to 50	1.0	3.0	10

**New**



## Thermometers, precision, blue spirit filled, yellow back, total immersion

**MBL®**

- Precision thermometers calibrated to closer tolerances and graduated at smaller intervals than general purpose thermometers
- Very fine etched graduations with black ceramic filling
- Yellow backed tubing for clear observation of blue spirit column
- Calibrated for 'total immersion'

Product Code	Range (°C)	Grads. (°C)	Tol. (±°C)	Pack qty.
30/101/02	-1 to 101	0.2	0.3	1

**New**



## Thermometers, with integral cone, spirit filled



- Complies with ISO 386
- Features an integral ground glass cone on the stem which allows direct fitting into Quickfit® jointed apparatus
- Filled with high visibility blue or green spirit

Product Code	Cone size	Range (°C)	Colour	Pack qty.
MF31/0/110S	10/19	-10 to 110	Blue	1
MF31/0/250S	10/19	-10 to 250	Blue	1
MF31/0/360S	10/19	-10 to 360	Green	1
MF31/1S	14/23	-10 to 110	Blue	1
MF31/2S	14/23	-10 to 250	Blue	1
MF31/3S	14/23	-10 to 360	Green	1

## Thermometer adapter



- Ideal for incorporating MBL® and plain stemmed thermometers into Quickfit® jointed glassware assemblies
- Screwthread joint allows easy depth adjustment of thermometer
- Complete with cap, ring and washer

Product Code	Thread size (mm)	Cone size	Acceptable dia. through screwcap (mm)	Pack qty.
ST51/13	13	14/23	6.0 - 7.0	2
ST52/13	13	19/26	6.0 - 7.0	2
ST53/13	13	24/29	6.0 - 7.0	2
ST54/13	13	29/32	6.0 - 7.0	2



## Thermometer pocket



- For incorporating thermometers into Quickfit® jointed glassware assemblies
- Pocket fits most Quickfit® still heads

Product Code	Cone size	Approx. stem length (mm)	Pack qty.
SH4A	14/23	45	1



## Thermometers, 'Bee-ka', blue spirit filled, yellow back, total immersion

**MBL®**

- Short length (155mm) for use with small beakers and Erlenmeyer flasks etc.
  - Can be left stood in a 50ml beaker without causing it to fall over
- Calibrated for 'total immersion'
- Permanent amber stain graduations
- Yellow back tubing for clear observation of spirit column

Product Code	Range (°C)	Grads. (°C)	Tol. (±°C)	Pack qty.
70/050/05	-10 to 50	1.0	0.5	10
70/110/10	-10 to 110	1.0	1.0	10





# Trays, troughs



## Trays, instrument, polypropylene



- Rectangular fabricated polypropylene trays
- Rigid and robust
- All sizes have 22mm deep vertical sides
- Can be autoclaved at 121°C

Product Code	Dimensions l x w (mm)	Pack qty.
TWR018	350 x 200	1
TWR020	350 x 250	1
TWR022	610 x 350	1

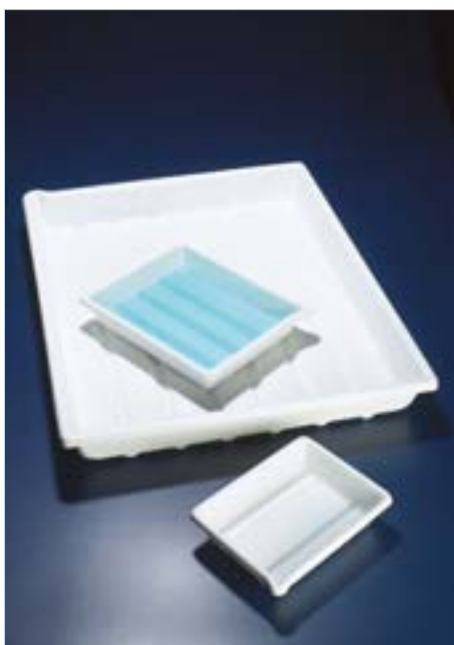

## Trays, photographic, white PVC



- Lightweight PVC trays
- Unbreakable in normal use
- Do not chip and are easily cleaned
- Accepts standard photographic paper
- Ribbed with pouring lip

Product Code	Internal dim. l x w (mm)	Height (mm)	Pack qty.
DWR006	260 x 200	65	1
DWR007	300 x 250	62	1
DWR008	420 x 320	75	1
DWR010	510 x 425	75	1
DWR012	650 x 520	90	1



## Trough, pneumatic, polyethylene



- Cylindrical, one piece pneumatic troughs
- Much lighter than glass
- Will withstand up to 80°C

Product Code	O.D. x height (mm)	Pack qty.
TGJ058	200 x 100	1
TGJ060	250 x 100	1
TGJ062	300 x 150	1

## Troughs, sterilising, polypropylene



- Rectangular sterilising troughs
- Robust and deep to accommodate a wide range of instruments etc.
- Can be autoclaved at 121°C

Product Code	Capacity (litres)	l x w (mm)	Height without lid (mm)	Height with lid (mm)	Pack qty.
TWR202	1	210 x 122	78	91	1
TWR204	10	390 x 290	110	130	1



## Troughs lids, sterilising, polystyrene

- Lids are to be purchased separately and are not autoclavable

Product Code	Description	Pack qty.
TWR205	Lid for TWR204	1

## Tube, plain, drawn to jet



- Plain borosilicate glass tube with jet
- Designed to fit the range of Quickfit® thermometer/inlet adapters having size 13 thread

Product Code	Approx O.D. (mm)	Approx length (mm)	Pack qty.
MF5	7	325	5

 For thermometer/inlet adapters, please refer to page 271.

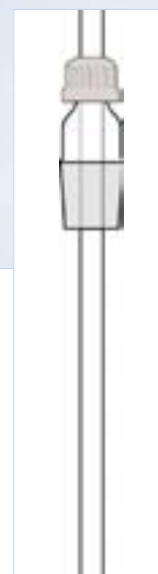

# Tubes



## Tubes, air/steam inlet, straight pattern



- Designed for introducing gases etc. into Quickfit® assemblies
- Stem with integral ground glass cone to fit Quickfit® sockets
- Lower end of tube is left plain for Glassblower to cut to length and draw to jet

Product Code	Cone size	Approx. stem length (mm)	Pack qty.
MF15/1	14/23	150	1
MF15/2	19/26	150	1
MF15/3	24/29	150	1



## Tubes, air/steam inlet, 90 bend



- With detachable plastic screwthread connector to facilitate the attachment of 9mm bore flexible tubing
- Ground glass cone on stem fits Quickfit® sockets
- Lower end of tube left plain for Glassblower to cut to length and draw to jet

Product Code	Cone size	Approx. stem length (mm)	Pack qty.
MF15/1B/SC	14/23	150	1
MF15/2B/SC	19/26	150	1
MF15/3B/SC	24/29	150	1

### Tube, centrifuge, conical base, graduated

PYREX®

- Centrifuge tube with white enamel graduations
- Graduated 0 - 3ml in 0.1ml divisions and 3 - 10ml in 0.5ml divisions
- Manufactured from Pyrex® borosilicate glass
- Can be centrifuged up to 3000 RCF values

Product Code	Capacity (ml)	Highest mark (ml)	Diam. (mm)	Length (mm)	Pack qty.
3460/02M	12	10	17	110	40



### Tube, centrifuge, conical base, plain

PYREX®

- Manufactured from chemically inert Pyrex® glass for contamination-free performance
- Conical shape with rim
- Can be centrifuged up to 3000 RCF values

Product Code	Capacity (ml)	Diam. (mm)	Length (mm)	Pack qty.
1680/02M	12	17	110	40



Always examine centrifuge tubes before use. Do not use if scratched, chipped or abraded.

### Tube, centrifuge, ground socket



- Borosilicate glass with precision-ground Quickfit socket to accept tapered stopper
- Conical or cylindrical shape
- Each tube is marked with its weight to the nearest 0.1g to enable tubes of similar weight to be selected from any batch
- Can be centrifuged at RCF values up to 3000

Product Code	Item code: glass stopper to fit	Shape	Joint size	Tube capacity (ml)	Tube O.D. x length mm	Pack qty.
BC24/C14T	2595/03M	Conical	14/15	10	17 x 115	10
BC24/C24R	2595/06M	Cylindrical	24/20	30	28.5 x 115	10



Tubes and stoppers should be ordered separately. Glass stoppers are listed on pages 256-258.





## Tubes, centrifuge, cylindrical type

**PYREX®**

- Cylindrical type, round base
- Uniform glass distribution in wall and base for improved strength
- Manufactured from chemically resistant Pyrex® glass
- Can be centrifuged at RCF values up to 3000

Product Code	Capacity (ml)	O.D. (mm)	Length (mm)	Pack qty.
1660/02M	10	16	90	40
1660/06M	25	24	90	40
1660/08M	45	30	90	40



Always examine tubes before use. Do not use if scratched, chipped or abraded.



## Tube, centrifuge, pear shape, ASTM

**PYREX®**

- Complies with ASTM D96 and D-1966
- For the determination of water and sediment in petroleum products
- Graduated in white enamel:
  - Lower stem graduated 0 to 1.5ml in 0.1ml divisions
  - Upper body graduated 1.5 to 5ml in 0.5ml divisions and from 5 to 10ml in 1ml

Product Code	Capacity (ml)	Approx overall length (mm)	Neck I.D. (mm)	Pack qty.
3440/02M	100	157	17	2



## Tube, centrifuge, conical, ASTM

**PYREX®**

- Complies with ASTM D96, D91, D-893 and D-1796
- In accordance with standard methods of testing for water and sediment in petroleum products
- Manufactured from chemically resistant Pyrex® borosilicate glass

Product Code	Capacity (ml)	Approx overall length (mm)	Neck I.D. (mm)	Pack qty.
3450/02MP	100	200	17	2

## Tubes, culture

**PYREX®**

- Ideal for culture work
- Manufactured from Pyrex® borosilicate glass
- High resistance to attack from water reduces leaching of contaminants which can cause pH changes
- PBT screwcaps with inert PTFE lined rubber disc
- Cap can withstand repeated dry heat and steam sterilisation cycles (121°C for 2 hours)

Product Code	Capacity (ml)	O.D. x length (mm)	Wall thickness mm	Thread size (mm)	Pack qty.
1636/24MP	9	14 x 100	1.5	13	40
1636/26MP	11	16 x 100	1.8	15	40
1636/04MP	14	16 x 125	1.8	15	40
1636/30MP	19	16 x 160	1.8	15	40
1636/32MP	15	18 x 100	1.8	18	40
1636/34MP	28	18 x 180	1.8	18	40
1636/36MP	20	20 x 100	1.8	20	40
1636/38MP	40	20 x 200	1.8	20	40
1636/10MP	50	22 x 200	1.8	22	40
1636/42MP	36	26 x 100	2.0	25	40
1636/44MP	70	26 x 200	2.0	25	40



*Culture tubes are not recommended for centrifuge work. Do not autoclave with a tightly screwed cap, always slacken off. Failure to adopt this procedure may result in tube breakage.*

## Tubes, culture, spares

Product Code	Description	Thread size (mm)	Pack qty.
4503/13	Cap with insert	13	20
4503/15	Cap with insert	15	20
4503/18	Cap with insert	18	20
4503/20	Cap with insert	20	20
4503/22	Cap with insert	22	20
4503/25	Cap with insert	25	20
4513/13M	Spare insert	13	20
4513/15M	Spare insert	15	20
4513/18M	Spare insert	18	20
4513/20M	Spare insert	20	20
4513/22M	Spare insert	22	20
4513/25M	Spare insert	25	20



# Tubes

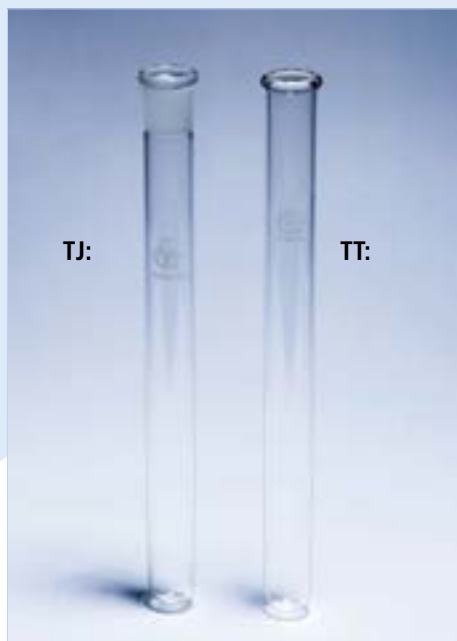

## Tubes, digestion, with socket



- Designed for use with blockheaters
- With Quickfit® precision-ground socket to accept air condensers etc.
- Manufactured from borosilicate glass for highest chemical and thermal durability

Product Code	Capacity (ml)	Diam. (mm)	Overall length (mm)	Joint size	Pack qty.
TJ15/16/1	15	16	145	14/23	5
TJ75/26/3	75	26	255	24/29	5
TJ100/26/3	100	26	300	24/29	5
TJ250/42/6	250	42	300	40/38	5

## Tubes, digestion, plain

- For use with block heaters
- With plain beaded neck
- Manufactured from borosilicate glass for highest chemical and thermal durability

Product Code	Capacity (ml)	Diam. (mm)	Overall length (mm)	Pack qty.
TT100/26	100	26	300	5
TT250/42	250	42	300	5



## Tubes, drying, angled



- For use with a desiccant such as calcium chloride
- Ground glass cone to fit Quickfit® apparatus

Product Code	Cone size	Pack qty.
MF23/1	14/23	1
MF23/2	19/26	1
MF23/3	24/29	1
MF23/4	29/32	1

## Tubes, drying, 'U' shaped



- For use with desiccants such as calcium chloride
- With two ground sockets to accept Quickfit® stopcock/tubing adapters etc.

Product Code	Socket size	Pack qty.
MF21/2	19/26	1



## Filter tubes, plain neck

**PYREX®**

- For small scale filtrations
- Ideal for use with Pyrex® short stem funnels

Product Code	Length (mm)	Tube O.D. (mm)	Tube I.D. (mm)	Sidearm O.D. (mm)	Pack qty.
2110/06M	150	18	15	6	10
2110/08M	150	24	22	6	10



## Gas distribution tubes

**PYREX®**

- Ideal for the dispersion of gas in liquids
- Borosilicate glass tube with sintered thimble
- Choice of thimble porosities to achieve optimum gas bubble size

Product Code	Porosity grade	O.D. of thimble mm	Nom. overall length mm	Diam. of tube (mm)	Pack qty.
3830/00M	0	15	300	8	2
3830/02M	1	15	300	8	2
3830/04M	2	15	300	8	2
3830/06M	3	15	300	8	2





# Tubes



 It is not recommended that these tubes be exposed to temperatures above 60°C.

## Gas delivery tubes, polypropylene



- Pre-bent rigid polypropylene delivery tubes
- Unbreakable in normal use - ideal substitutes for fragile glass alternatives
- Suitable for many types of gas collection experiments in schools and universities

Product Code	Key	Type	Tube O.D. (mm)	Tube I.D. (mm)	Pack qty.
DT001	A	90 Degree	6	4	5
DT002	B	Bung Top	6	4	5
DT003	C	Side Arm	6	4	5
DT004	D	Straight tube	6	4	5
DT005	E	Double Bend	6	4	5
DT006	F	U Bend	6	4	5
DT007	G	Large U Bend	6	4	5
DT008	H	Small U bend	6	4	5
DT009	I	Test tube side arm	6	4	5
DT001MP	-	Multi pack - One of each shape	6	4	9



 For advice on the safe heating of Pyrex® glassware, please refer to the technical information section.

## Tubes, test, with rim, medium wall

**PYREX®**

- Conforms to ISO 4142
- High quality test tubes designed and constructed for optimum performance
- Manufactured from Pyrex® borosilicate glass which gives superior performance to neutral borosilicate and soda-lime glass
  - Allows use at temperatures up to 500°C
  - Excellent resistance to chemical attack

Product Code	Approx capacity to rim (ml)	Dimensions O.D. x length (mm)	Wall thickness (mm)	Pack qty.
1620/02M	4	10 x 75	1.0	100
1620/04M	6	12 x 75	1.0	100
1620/06M	8	12 x 100	1.0	100
1620/09M	14	16 x 100	1.2	100
1620/10M	18	16 x 125	1.2	100
1620/12M	22	16 x 150	1.2	100
1620/14M	23	16 x 160	1.2	100
1620/15M	34	18 x 180	1.2	100
1620/16M	28	18 x 150	1.2	100
1620/20M	50	24 x 150	1.2	100
1620/22M	66	24 x 200	1.2	50

## Tubes, test, with rim, heavy wall

**PYREX®**

- Conforms to ISO 4142
- Test tubes with a heavy wall to provide extra mechanical strength
- Robust construction reduces possibility of breakages:
  - Lower replacement costs
  - Improved user safety
- Pyrex® borosilicate glass for high resistance to thermal shock and chemical attack

Product Code	Approx capacity to rim (ml)	Dimensions O.D. x length (mm)	Wall thickness (mm)	Pack qty.
1624/02M	3	10 x 75	1.5	100
1624/04M	5	12 x 75	1.5	100
1624/06M	6	12 x 100	1.5	100
1624/10M	15	16 x 125	1.8	100
1624/12M	18	16 x 150	1.8	100
1624/16M	24	18 x 150	1.8	100
1624/20M	45	24 x 150	1.8	100



## Tubes, test, without rim, medium wall

**PYREX®**

- Conforms to ISO 4142
- High quality test tubes designed and constructed for optimum performance
- Manufactured from Pyrex® borosilicate glass which gives superior performance to neutral borosilicate and soda-lime glass
- Allows use at high temperatures - up to 500°C
- Ideal for microbiology culture work
- Excellent resistance to chemical attack

Product Code	Approx capacity to rim (ml)	Dimensions O.D. x length (mm)	Wall thickness (mm)	Pack qty.
1622/02M	4	10 x 75	1.0	100
1622/04M	6	12 x 75	1.0	100
1622/06M	8	12 x 100	1.0	100
1622/09M	14	16 x 100	1.2	100
1622/10M	17	16 x 125	1.2	100
1622/12M	22	16 x 150	1.2	100
1622/14M	23	16 x 160	1.2	100
1622/15M	34	18 x 180	1.2	100
1622/16M	28	18 x 150	1.2	100
1622/20M	50	24 x 150	1.2	100
1622/22M	66	24 x 200	1.2	50



For advice on the safe heating of Pyrex® glassware, please refer to the care and maintenance section on pages 295-296



## Tubes, test, without rim, heavy wall

**PYREX®**

- Conforms to ISO 4142
- Rimless test tubes with a heavy wall to provide extra mechanical strength
- Robust construction reduces possibility of breakages:
  - Lower replacement costs
  - Improved user safety
- Manufactured from Pyrex® borosilicate glass for high resistance to thermal shock and chemical attack

Product Code	Approx capacity to rim (ml)	Dimensions O.D. x length (mm)	Wall thickness (mm)	Pack qty.
1626/02M	3	10 x 75	1.5	100
1626/04M	5	12 x 75	1.5	100
1626/06M	6	12 x 100	1.5	100
1626/10M	15	16 x 125	1.8	100
1626/12M	18	16 x 150	1.8	100
1626/16M	24	18 x 150	1.8	100
1626/20M	45	24 x 150	1.8	100



## Tubes, test, ground socket



- High quality test tubes with a precision-ground Quickfit® socket
- Accepts Quickfit® glass stoppers
- Manufactured from borosilicate glass for excellent resistance to chemical attack and thermal shock
- Tubes and stoppers should be ordered separately

Product Code	Approx capacity ml	Dimensions O.D. x length (mm)	Socket size	Item code: stopper	Pack qty.
MF24/0/4	5	14 x 100	10/19	SB10	5
MF24/12/4	10	17 x 100	12/21	SB12	5
MF24/1	11	19 x 100	14/23	SB14	5
MF24/1/5	15	19 x 125	14/23	SB14	5
MF24/1/6	19	19 x 150	14/23	SB14	5
MF24/2	19	23 x 100	19/26	SB19	5
MF24/2/6	31	23 x 150	19/26	SB19	5
MF24/3	54	29 x 150	24/29	SB24	5
MF24/3/8	75	29 x 200	24/29	SB24	5
MF24/5	195	41 x 250	34/35	SB34	5



For glass stoppers, please see pages 256-258.

## Tubes, test, ground socket, with stopper

**PYREX®**

- Pyrex® borosilicate glass with ground socket
- Supplied with interchangeable polyethylene stopper

Product Code	Capacity (ml)	Dimensions O.D. x length (mm)	Stopper size	Pack qty.
1630/02M	5	13 x 100	10/19	10
1630/06M	10	18 x 125	14/23	10
1630/10M	25	22 x 150	19/26	10
1630/12M	50	26 x 200	24/29	10

 For spare polyethylene stoppers, please see page 258.



## Tubes, test, graduated, ground socket, with stopper PYREX®

- With white enamel graduations to indicate capacity
- Pyrex® borosilicate glass construction provides excellent resistance to chemical attack and thermal shock
- Supplied with interchangeable polyethylene stopper

Product Code	Capacity (ml)	Grads. (ml)	Dimensions O.D. x length (mm)	Stopper size	Pack qty.
1628/06M	5	0.1	13 x 100	10/19	10
1628/10M	10	0.2	18 x 125	14/23	10
1628/18M	25	0.5	22 x 150	19/26	10
1628/22M	50	1.0	26 x 200	24/29	10

 For spare polyethylene stoppers, please see page 258.



# Tweezers, watch glasses



## Tweezers, PMP / POM



- High quality, autoclavable tweezers
- Available with pointed or rounded ends
- Fine tooth grips for secure handling of samples

Product Code	Material	Colour	Ends	Length (mm)	Pack qty.
TWY260	PMP	White	Sharp	115	1
TWY262	PMP	White	Sharp	145	1
TWY264	POM	Yellow	Round	180	1
TWY266	POM	Yellow	Round	250	1

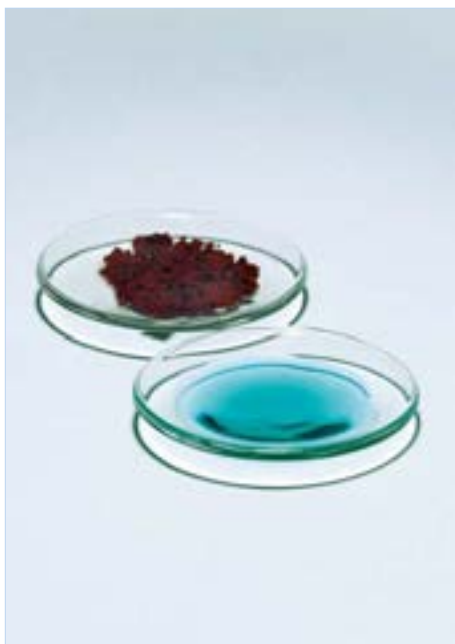

## Watch glasses

**PYREX®**

- For evaporation work and covering heated beakers
- Manufactured from heat resisting Pyrex® borosilicate glass
- Fire-polished edges to reduce chipping and breakage

Product Code	Nom. diam. (mm)	Pack qty.
1060/04D	40	10
1060/06D	50	10
1060/09D	60	10
1060/10D	80	10
1060/14D	100	10
1060/18D	125	10
1060/20D	150	10
1060/21D	200	10
1060/24D	250	10



Avoid sudden temperature changes which can result in breakage. Always heat and cool gradually.

## Water estimators, light entrainers



- Complies with BS 756
- Dean & Stark pattern receivers for the determination of the water content in petroleum products
- For use with solvent entrainers which are lighter than water
- Borosilicate glass with graduated tube
- Receiver WE6/23/10T is fitted with PTFE GP Rotaflo® stopcock for easy drainage

Product Code	Description	Capacity (ml)	Grads. (ml)	Socket size	Cone size	Pack qty.
WE6/23/2	Receiver	2.0	0.05	19/26	24/29	1
WE6/23/7	Receiver	7.5	0.10	19/26	24/29	1
WE6/23/10T	Receiver with stopcock	10.0	0.10	19/26	24/29	1
WE6/23/25	Receiver	25.0	0.20	19/26	24/29	1



## Water estimators, heavy entrainers



- Complies with BS 756
- For the determination of water content in petroleum products using a solvent entrainer which is heavier than water
- Also suitable for the estimation of volatile oil content
- Highest quality borosilicate glass with graduated tube and Quickfit® precision-ground joints

Product Code	Description	Capacity (ml)	Grads. (ml)	Socket size	Cone size	Pack qty.
WE7/23/3	Receiver	3.0	0.05	19/26	24/29	1
WE7/23/12	Receiver	12.5	0.1	19/26	24/29	1



# Weighing



## Weighing scoop, Glass

**PYREX®**

- With hollow stem to aid introduction of the powder into narrow neck vessels e.g. volumetric flasks
- The flat base ensures stability on the balance pan

Product Code	Nom. capacity (ml)	Overall length (mm)	Pack qty.
2115/02M	3	70	10
2115/04M	6	85	10
2115/06M	10	100	10



## Weighing scoop, HDPE



- Lightweight HDPE weighing boats/scoops
- Good chemical resistance

Product Code	Capacity (ml)	Body dim. (mm)	Overall length (mm)	Pack qty.
FWC320	2	33 x 15	40	10
FWC322	10	55 x 25	64	10
FWC324	35	85 x 38	100	10



## Weighing bottles

**PYREX®**

- Complies with DIN 12605
- Chemically inert Pyrex® borosilicate glass
- Lightweight construction with ground glass stoppers
- Choice of squat or tall form bottles

Product Code	Capacity (ml)	Diam. (mm)	Height (mm)	Shape	Pack qty.
WB25/40	8	25	40	Tall	1
WB30/50	20	30	50	Tall	1
WB30/60	25	30	60	Tall	1
WB35/30	10	35	30	Squat	1
WB35/70	40	35	70	Tall	1
WB40/80	60	40	80	Tall	1
WB50/30	20	50	30	Squat	1
WB50/80	100	50	80	Tall	1

**i** Weighing bottle supplied complete with ground lid. WB35/30 and WB50/80 are supplementary to DIN range.

# Technical Information





# Technical information - glassware

## Glassware

Glass is an inorganic mixture of metal oxides fused together at high temperatures, which upon cooling, solidifies into the clear, rigid, non-crystalline, versatile material known widely across the globe.



## Pyrex® Borosilicate Glass

All Pyrex®, Quickfit®, SVL® and many MBL® branded SciLabware products are manufactured from borosilicate glass (unless otherwise stated).

## Standards

Pyrex® is a Type 3.3 borosilicate glass which complies with ISO 3585 and DIN 12217. For further compliance information please see below:

	<b>3.3 borosilicate glass</b>	<b>Soda-lime glass</b>
ASTM E-438	Type 1 Class A	Type 2
US Pharmacopoeia	Type 1	Type 3
European Pharmacopoeia	Type 1	Type 3

Due to the demanding conditions that borosilicate glass is subjected to, maximum chemical toughness, minimum thermal expansion and high resistance to thermal shock make Pyrex® the ideal material for use in the laboratory.

Many SciLabware Ltd products also conform to other standards set out for laboratory glassware; for example beakers comply to ISO 3819 and volumetric flasks comply to ISO 1042 and DIN 12664. Typically these standards will specify not only glass type, but also dimensional detail, volumetric accuracy and tolerances.

## Chemical Composition

Pyrex® glass has the following typical composition (% by weight):

	<b>3.3 borosilicate glass</b>	<b>Soda-lime glass</b>
SiO <sub>2</sub>	80.6%	69.0%
B <sub>2</sub> O <sub>3</sub>	13.0%	1.0%
Na <sub>2</sub> O	4.0%	13.0%
Al <sub>2</sub> O <sub>3</sub>	2.3%	4.0%

## Physical Properties

	<b>3.3 borosilicate glass</b>	<b>Soda-lime glass</b>
Coefficient of expansion (20 – 300°C)	3.3x10 <sup>-6</sup> K <sup>-1</sup>	9.1x10 <sup>-6</sup> K <sup>-1</sup>
Density	2.23g/cm <sup>3</sup>	2.5g/cm <sup>3</sup>
Refractive index (Sodium D line)	1.474	1.514
Dielectric constant (1MHz, 20°C)	4.6	7.2
Specific heat (20°C)	750J/kg°C	–
Thermal conductivity (20°C)	1.14W/m°C	–
Poissons Ratio (25 - 400°C)	0.2	0.22

## Chemical Properties

Pyrex® borosilicate glass has a very high resistance to attack from water, acids, salt solutions, halogens and organic solvents. Only hydrofluoric acid, hot concentrated phosphoric acid and strong alkaline solutions cause appreciable corrosion of the glass.

## Hydrolytic resistance

For many applications, it is important that laboratory glassware has excellent hydrolytic resistance; e.g. during steam sterilisation procedures, where repeated exposure to water vapour at high temperature can leach out alkali (Na<sup>+</sup>) ions. Pyrex® borosilicate glass has a relatively low alkali metal oxide content and consequently a high resistance to attack from water. Pyrex® borosilicate glass fits into Class 1 for hydrolytic resistance according to ISO 719 (98°C) and ISO 720 (121°C). Soda-lime glass is Class 3 according to ISO 719.

## Acid resistance

Glasses with a high percentage weight of silica (SiO<sub>2</sub>) are less likely to be attacked by acids. Pyrex® borosilicate glass is over 80% silica and therefore remarkably resistant to acids (with the exception of hot concentrated phosphoric acid and hydrofluoric acid). Glass is separated into four acid resistant classes. Both Pyrex® borosilicate and Soda-lime correspond to Class 1 in accordance with DIN 12116. Pyrex® borosilicate glass also meets the requirements of ISO 1776

## Alkali resistance

The alkali resistance of both Pyrex® borosilicate and Soda-lime glass meet Class 2 requirements as defined by ISO 695. Pyrex® borosilicate glass also meets DIN 52322.

# Technical information - glassware

## Temperature resistance

Pyrex® borosilicate glass has excellent thermal properties at both high and low temperatures. The maximum recommended working temperature for laboratory glassware manufactured from Pyrex® is 500°C (for short periods of time only). Special care should be taken at temperatures above 150°C to ensure both heating and cooling are achieved in a slow and uniform manner (see Care and Maintenance of Laboratory Glassware).

Pyrex® also performs excellently at lower temperatures. Pyrex® can withstand conditions down to approximately -192°C and is suitable for use with liquid nitrogen. In normal laboratory use, temperatures of -70°C are easily sustained for lengthy periods. Again special care should be taken to avoid sudden changes in temperature, and cooling should be achieved in a slow uniform manner.

## Optical data

Pyrex® borosilicate glass is clear and colourless in appearance and thus transmits light through the visible range of the spectrum. This quality makes it ideal for work involving photochemical reactions, for example chlorinations. The graph (below) shows the degree of transmission of light as a function of wavelength in the ultra-violet, visible and infra-red regions of the spectrum. For the majority of glassware detailed in our catalogue, the thickness of the glass is 2–5mm.

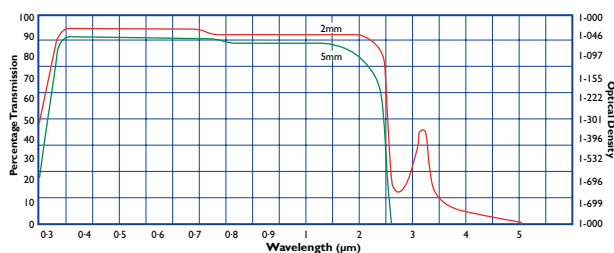

## Amber coated Pyrex® glassware

Several SciLabware glass products, including media-lab bottles and volumetric flasks, are available in amber-coated glass. The glassware is coated on the exterior surface with a brown diffusion colour which results in a strong absorption in the short wavelength region up to 500nm. This feature is particularly useful when handling reagents that are light-sensitive.

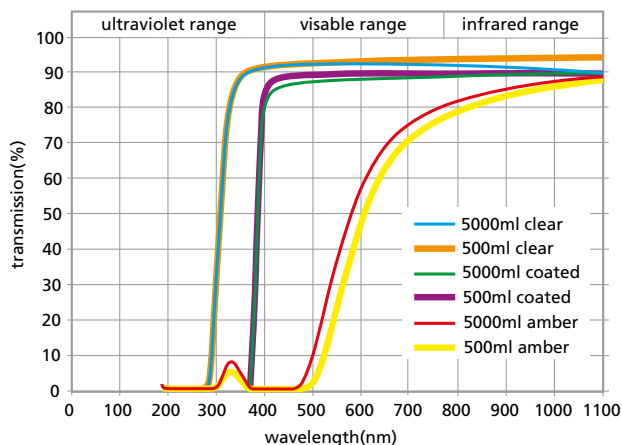

## Glassblowing data

Listed in this catalogue are some Pyrex® and Quickfit® items that are suitable for further manipulation and processing. These items include stopcocks, ground glass joints, sinters and screwthreads. When working with these products, Glassblowers may find the following information useful regarding Pyrex® borosilicate glass:

Working point	=	1252°C
Softening point	=	821°C
Annealing point	=	565°C
Strain point	=	510°C

## Pyrex® bottles with trace codes

Pyrex® media bottles are used in many laboratory processes but they are also used in packaging, which often has to meet the strict requirements of the United States and European Pharmacopoeias (USP and EP), GMP and ISO 9000.

To meet these stringent requirements, all Pyrex® media bottles are printed with a 'Trace Code'. This Trace Code allows the product to be traced to the point of production and the matching batch. This code is our commitment to support your quality management documentation and can be easily downloaded from the SciLabware web site by keying in the 8-digit code shown on the side of the bottle. Trace codes can be found on all Pyrex® 1516/: 1517/: 1518/: 1519/: 1520/: 1523/: 1524/: series media-lab bottles.



## Pyrex® bottles with plastic coating



The Pyrex® range of 1518/: series media-lab bottles have a plastic coating to provide protection from mechanical impact and to help reduce leakage of the contents should the glass break.

The maximum working temperature for these bottles is 135°C but long term exposure (>30 mins) should be avoided.

Avoid exposure to direct heat from a hotplate or a Bunsen flame. The 1518/: series media-lab bottle is suitable

for freezing at -30°C and can also be used in microwave ovens.

Please note that the plastic coating does not increase the permissible pressure at which the bottles can be used and a protective screen is recommended for all pressure work.

# Technical information - glassware

## Centrifuge tubes

This catalogue lists a number of Pyrex® and Quickfit® centrifuge tubes. Within the product information for each entry we advise the maximum Relative Centrifugal Force (RCF) they can be subjected to.

Before centrifuging, it is important to calculate the actual RCF values that will be generated. This can quickly be determined by using the following nomogram.

To calculate the RCF value at any point along the tube, measure the radius, in mm, from the centre of the centrifuge spindle to the particular point.

### RCF Values

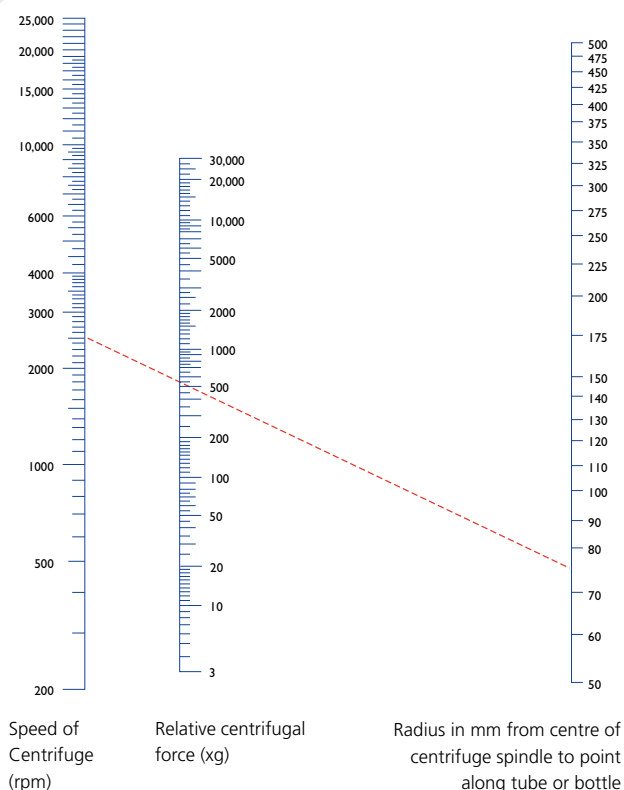

NB: The chosen point should be the base of the tube as this area will experience the maximum RCF.

Note the radius value from the right of the table and draw a line to the appropriate centrifuge speed value on the left hand column. The RCF value is the point where the line crosses the centre column.

The nomogram is based on the following equation:

$$RCF = (11.17 \times 10^{-7}) RN^2$$

R = Rotational radius (in mm)

N = Rotational speed (in RPM)

The allocated RCF values are for tubes in good condition. Do not use centrifuge tubes which are scratched, abraded or chipped as the strength will be seriously impaired.

## Sintered discs

The SciLabware ranges of filtration glassware utilise sintered discs manufactured from Pyrex® borosilicate glass. Since they are manufactured from Pyrex® they are resistant to the majority of corrosive reagents, unaffected by ammonia, sulphuric acid and other solvents that are damaging to filter paper. The sintered glassware is available in six porosity classes from 0 – 5, as outlined in the table below. The pore sizes indicated, give a range of pores present within the sinter disc. Therefore, the size of particles that will be obstructed will generally be of a size at the upper end of the range.

Porosity Grade	ISO 4793 designation	Pore index (mic.)	Principal uses
0	P250	160 - 250	Coarse filtration, gas dispersion and support for other filter material
1	P160	100 - 160	Course precipitate filtration, gas dispersion, coarse grain material filtration
2	P100	40 - 100	Medium and crystalline precipitate filtration, medium filtration and washing of gases
3	P40	16 - 40	Analytical work with medium precipitates
4	P16	10 - 16	Analytical work with fine precipitates
5	P10	4 - 10	Bacteria filtration

In addition to the above detail, sinters should be treated under the same conditions as described in the general Pyrex® thermal properties as listed on page 289.

When using new sintered glassware for the first time, we recommend a wash with hydrochloric acid followed by several rinses with distilled water to remove any residual glass dust particles from the sinter.

# Technical information - glassware

## Sintered discs (continued)

In order to select the correct sinter for any specific application, in addition to the porosity, it is also useful to know the flow rates of liquids and gases through the sinters. These values are given in the charts below for water and air. The data applies to 30mm diameter filter discs. The flow rates for other disc diameters can be calculated by multiplying the value read off by the conversion factor given in the table below.

Filter disc dia. mm	10	20	30	40	60	90	120	150	175
Conversion factor	0,13	0,55	1	1,5	2,5	4,3	6,8	9,7	15

## Water flow rate

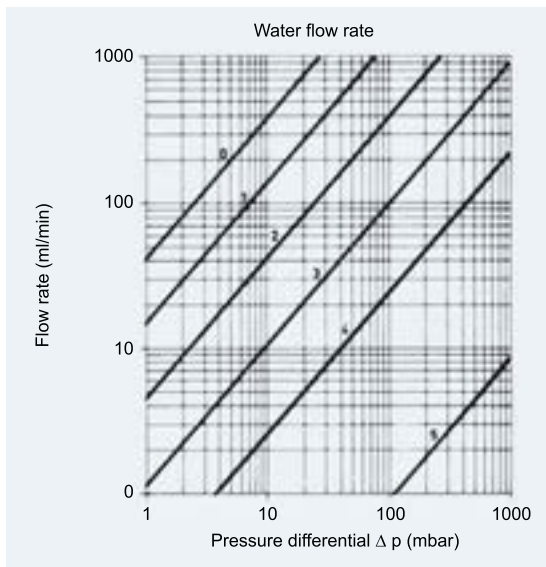

## Dry-air flow rate

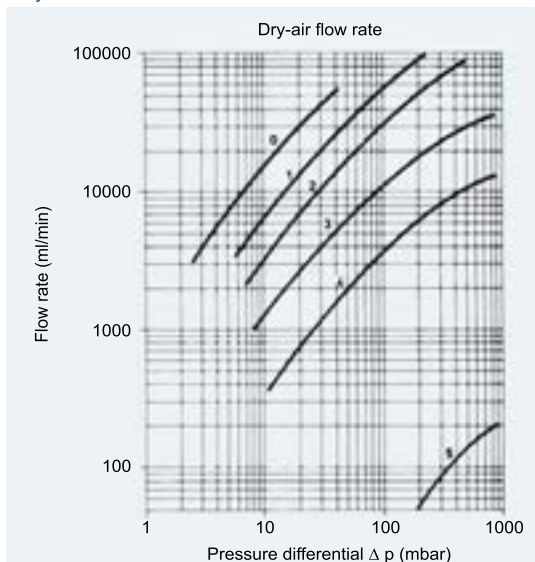

## Quickfit® Products

### Conical joints

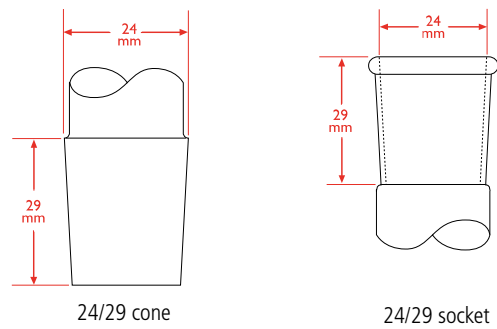

### Spherical joints

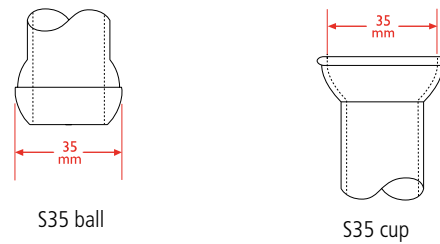

### Flat flange

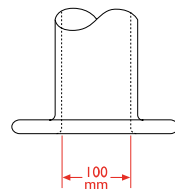

100mm bore flange

### Screwthread

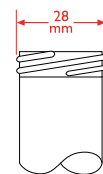

28 screwthread

## Conical Joints - size designation

Size designation	Actual dia. of wide end (mm)	Actual dia. of narrow end (mm)	Nominal length of engagement (mm)
7/16	7.5	5.9	16
10/19	10.0	8.1	19
12/21	12.5	10.4	21
14/23	14.5	12.2	23
19/26	18.8	16.2	26
24/29	24.0	21.1	29
29/32	29.2	26.0	32
34/35	34.5	31.0	35
40/38	40.0	36.2	38
45/40	45.0	41.0	40
50/42	50.0	45.8	42
55/44	55.0	50.6	44
60/46	60.0	55.4	46

# Technical information - glassware

## Quickfit® screwthread joints

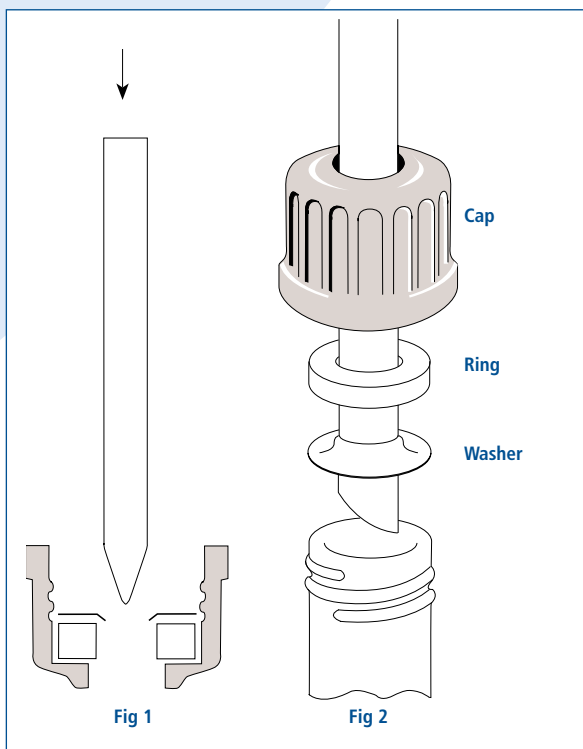

## Screwcap assembly

When using screwthreads it is important that the PTFE washer is fitted carefully and correctly. This is best achieved by opening out the washer to the correct diameter using a tapered former. This should be carried out with the silicone rubber ring and PTFE washer in position in the plastic cap as shown in **Fig 1**. Withdraw the tapered former and remove the rubber ring and washer from the cap.

Fit each component separately to the fitting which is to be held, as shown in **Fig 2**, and screw the cap on to the thread. It is advisable that the ends of all fittings should be slightly tapered or fired in a Bunsen flame to remove sharp edges and produce a slight taper.

## Quickfit® flask dimensions

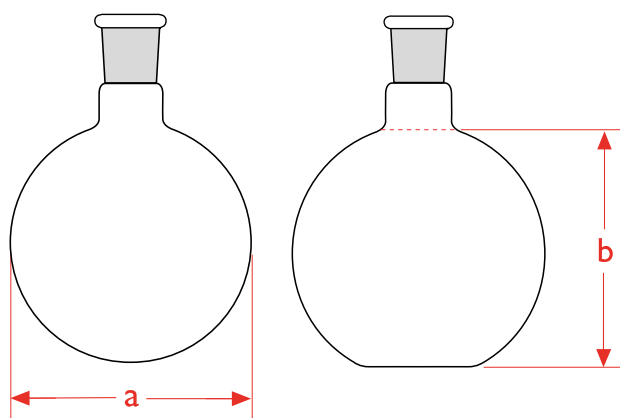

## Quickfit® flask dimensions

The body diameter of Quickfit® Round Bottomed and Flat Bottomed flasks comply with ISO 1773 (BS 6352).

Nominal capacity ml	Approx bulb dia. 'a' mm	Approx bulb height 'b' mm	Nominal capacity ml	Approx bulb dia. 'a' mm	Approx bulb height 'b' mm
5	25	-	1000	132	115
10	30	-	2000	166	155
25	40	-	3000	188	-
50	50	40	5000	220	-
100	65	55	10000	279	-
150	75	65	20000	345	-
250	85	75	-	-	-
500	105	95	-	-	-

# Technical information - glassware

## Volumetric Glassware

SciLabware Ltd manufactures two brands of volumetric glassware, Pyrex® and MBL®. As the name indicates Pyrex® volumetrics are manufactured solely from Pyrex® borosilicate glass. MBL® volumetric products are manufactured from borosilicate and soda-lime glass.

Soda-lime glass is generally used for Class B products or where long term exposure to chemicals is unlikely, e.g. one mark pipettes.

Pyrex® volumetric glassware has superior thermal and chemical resistance and is better suited to glassware for storage of solutions, e.g. flasks.

The use of Pyrex® borosilicate glass for volumetric glassware means accuracy is retained over a longer working lifetime than their soda-lime equivalents. With everyday use, volumetric glassware requires recalibration. Soda-lime glass items will generally necessitate twice as many recalibrations as items constructed from borosilicate glass.

ASTM 542 and ISO 4787 international standards for calibration of laboratory volumetric glassware recommend that volumetric flasks are recalibrated at the following intervals (or sooner if chemical corrosion is observed): Borosilicate – 10 years; Soda-lime – 5 years.

## Volumetric accuracy

SciLabware volumetric glassware is manufactured and calibrated in accordance with international ISO standards to permit very accurate determination and measurement of specific volumes. They are available in two accuracy classes: Class A/AS and Class B. The two classes differ in the accuracy of measurement with a Class A/AS being the highest accuracy, and Class B is approximately half of a Class A. Class A has the same high tolerances as Class A, but is designed to permit more rapid outflow on burettes and pipettes.

## Inscriptions

SciLabware volumetric glassware is manufactured and calibrated in accordance with international ISO requirements. All of our volumetric glassware is marked with a set of inscriptions in accordance with any specific standard associated with it.

<b>Tolerance</b>	Class A/AS – Highest level of accuracy. Class B – General purpose work calibrated to a lower level of accuracy
<b>Standard</b>	The standard to which the product conforms
<b>Graduation</b>	Pyrex® and MBL® volumetric glass is graduated in ml (millilitres) in accordance with ISO
<b>IN</b>	Calibrated to contain
<b>EX</b>	Calibrated to deliver
<b>Blowout</b>	Indication that last drop should be blown out of jet
<b>Temp °C</b>	All Pyrex® and MBL® volumetric glassware is calibrated at 20°C
<b>Certification</b>	All Class A/AS Works Certified glassware bears a serial number for identification and traceability.



## Certification

Many of our range of volumetric products are available with certification. Our certificates confirm that the product has been tested for compliance to the appropriate standard. Below is an overview of the certification that is offered by SciLabware.

## Works Certified Products

Pyrex® and MBL® Class A/AS Works Certified volumetric flasks, pipettes, cylinders and burettes are inscribed with an individual serial number and are supplied with an individual calibration certificate. Each certificate includes details of the actual volume, uncertainty estimation for the calibration and the required tolerance for compliance.

# Technical information - glassware



## Batch certificates

For our ranges of Pyrex® Class A volumetric flasks and cylinders and MBL® Class AS pipettes a downloadable batch certificate is available from the SciLabware website. The batch certificate contains detailed information pertaining to the specific production batch including average volume and standard deviation for the batch.

To download a batch certificate visit [www.scilabware.com](http://www.scilabware.com) and go the 'certificates' section then follow the links for the specified product. Simply enter the serial number marked on each volumetric item and the batch certificate is downloaded as a pdf.

Please visit [www.scilabware.com](http://www.scilabware.com) to download certificates and technical information.

## Re-calibration

Normally, volumetric glassware only needs re-calibrating after extensive or demanding usage, which may have affected the original accuracy.

Re-calibration is usually not necessary if:

- The glassware is new but been in storage for some time. Age does not affect accuracy.
- The glassware is only subjected to moderate temperatures such as cleaning in a washing machine or sterilising in an autoclave at 121°C.
- The glassware has been used for less than 5 years with no repeated use of corrosive chemicals or strong acids/ alkalis.

However, recalibration should definitely be considered under the following circumstances:

- The glassware is made from soda-lime glass and has been in use for 5 years.
- The glassware is made from borosilicate and has been in use for 10 years.
- The glassware has been subjected to temperatures in excess of 150°C.
- The glassware is frequently used with strong acids or bases.
- There are any signs of chemical corrosion e.g. frosting of internal glass surfaces.

## Care and maintenance of laboratory glassware

SciLabware Ltd has a commitment to provide the highest quality glassware products. All of our glassware is manufactured with great care in order to provide you with a reliable piece of laboratory equipment.

To obtain maximum life and performance from your glassware, correct handling is essential. The following notes will serve as a guide to new users and to remind more experienced handlers of the recommended procedures.

### General precautions

Before using any piece of glassware, take time to examine it carefully and ensure that it is in good condition. Do not use any glassware which is scratched, chipped, cracked or etched. Defects like these can seriously weaken the glass and make it prone to breakage in use.

- Dispose of broken or defective glass-ware safely. Use a purpose-designed disposal bin that is puncture resistant and clearly labelled.
- Pyrex® laboratory glassware should under no circumstances be disposed of in a domestic glass recycling stream (e.g. bottle banks), since its high melting point make it incompatible with other glass (soda-lime glass) for recycling. The correct method of disposal is to include it in with general waste in accordance with the relevant guidelines, provided that the glass is free of any harmful chemical contamination.
- Never use excessive force to fit rubber bungs into the neck of glass aspirators, test tubes, conical flasks, etc. Take care to select the correct size.
- Many SciLabware products are provided with durable, easy to use screwthread connectors, to allow installation of any tubing. When attaching tubing, ensure the screwthread connector is removed from the glassware, the tubing is lubricated and protective gloves are worn. Never use excessive force to connect rubber hose or tubing.
- Lifting or carrying large glass flasks, beakers or bottles etc. by the neck or rim can be very dangerous. It is best to provide support from the base and sides.
- When stirring solutions in glass vessels, such as beakers and flasks, avoid using stirring rods with sharp ends which can scratch and weaken the glassware.
- Do not mix concentrated sulphuric acid with water inside a glass measuring cylinder.  
The heat of reaction can break the seal at the base of the cylinder.
- We recommend that all glassware is washed before it is first used.

### Heating and cooling

The maximum recommended working temperature for Pyrex® and Quickfit® glassware is 500°C (for short periods only). However, once the temperature exceeds 150°C extra special care should be taken to ensure that heating and cooling is achieved in a slow and uniform manner.

- Pyrex® borosilicate glass is microwave safe. However, as with any microwave vessel, be sure it holds a microwave absorbing material, such as water, before placing in the oven. Many SciLabware items utilise plastic screwcaps and connectors. These are typically manufactured from polypropylene or PTFE, both of which are microwave safe.
- Do heat vessels gently and gradually to avoid breakage by thermal shock. Similarly, allow hot glassware to cool gradually and in a location away from cold draughts.
- If you are using a hotplate, ensure that the top plate is larger than the base of the vessel to be heated. Also, never put cold glassware onto a hotplate which is already well heated. Warm up gradually from ambient temperature.
- When autoclaving Pyrex® containers, e.g. bottles with screwcaps – always slacken off the caps. Autoclaving with tightly screwed caps can result in pressure differences and consequent breakage.
- If you are using a Bunsen burner, employ a soft flame and use a wire gauze with ceramic centre to diffuse the flame.

### Preparation of media

Take great care when heating liquids that have a HIGH VISCOSITY. Viscous liquids can act as thermal insulators and can cause 'hot spots' leading to thermal breakage of the glassware. This is particularly important with MEDIA SOLUTIONS as the viscosity usually increases considerably during preparation.

- Do regularly stir the solution to assist even distribution of heat. If using a magnetic stirrer set the speed to ensure adequate agitation of the whole liquid.
- Do not use glass vessels with thick walls e.g. Pyrex® Heavy Duty Ware or standard beakers or flasks which have capacities of 5 litres or greater.



# Technical information - glassware

## Vacuum and pressure use

Because working conditions can vary enormously, SciLabware cannot guarantee any glassware against breakage when used under vacuum or pressure. The application of positive pressures inside glass apparatus is particularly hazardous and should be avoided if at all possible. Safety precautions should always be taken to protect personnel and a number of these are listed below:

- Do not use flat bottomed vessels such as Erlenmeyer flasks and bottles under vacuum as they are likely to implode. Exceptions are vessels with specially thickened walls such as Büchner filter flasks and desiccators.
- Always use an adequate safety screen and/or protective cage.
- Under no circumstances use glassware that is scratched, cracked or chipped. Its strength will be seriously impaired.
- Avoid stress caused by over-tightening clamps. Support glassware gently where possible.
- Never subject glassware to sudden pressure changes. Always apply and release pressure gradients and vacuums gradually. Always use an adequate safety screen and/or protective cage.

## Ground glass joints

Lubricate the ground surfaces of joints to prevent leakage in use and facilitate separation. Use a silicone-free laboratory grease and apply a light coat completely around the upper part of the joint. Alternatively, consider PTFE joint sleeves which can be fitted between the cone and socket.

If ground glass joints do seize, then the following remedies can be considered:

- Always wear thick protective gloves and safety spectacles. Never use force.
- Carefully rock the cone in its socket to achieve separation.
- If the joint is dry, try to provide lubrication. Hold the joint upright and add penetrating oil to the top of the cone. Wait until the penetrating oil is well into the joint before trying to separate.
- If the use of temperature is permissible, e.g. no volatile liquids present, then warm the outer socket under a running stream of hot water from the tap. Hold under the tap for a few minutes before trying to separate.

## Sintered glassware

New apparatus with sintered glass discs should be washed before use to remove loose particles of dust etc. Wash through with hot dilute hydrochloric acid followed by a thorough rinse with water.

- Do ensure that the porosity of the sintered disc is appropriate for the application. Porosity 0 sinters are for coarse filtration, whilst higher grades give progressively finer filtration.
- Never subject sintered glassware to differential pressures exceeding 100kN/m<sup>2</sup> (1 bar).

## Volumetric glassware

Do ensure that all volumetric glassware is kept scrupulously clean. Dirt, and especially grease, can distort the shape of the meniscus and also cause droplets of liquid to adhere to the vessel walls. Both seriously impair accuracy. (Good cleanliness is indicated by uniform wetting of the glass surface with distilled water).

- Never pipette by mouth. Always use a purpose designed pipette filler.
- Autoclaving at 121°C and cleaning in automatic dish-washers is acceptable and will not affect the accuracy of Pyrex<sup>®</sup> or MBL<sup>®</sup> glassware.
- All items should be held in a vertical position when reading the meniscus. The meniscus should be at eye level to avoid parallax errors.
- If using strong corrosive acids etc. select volumetric ware manufactured from chemically resistant Pyrex<sup>®</sup> borosilicate glass.
- Do not expose volumetric glassware to direct heat e.g. hotplates, bunsen flame.

Pyrex<sup>®</sup> is a registered trademark of Corning Inc.  
SciLabware is a registered user

# Technical information - pipettes

## MBL® pipettes

Precise volumetric measurement requires high quality and high performance equipment. Manufactured from soda-lime glass, MBL® pipettes possess both the chemical and physical resilience needed within the laboratory environment. They are printed with durable amber stain inscriptions, providing the user with long lasting, high contrast markings. MBL® pipettes also include a re-engineered jet; not only does this provide robust mechanical strength; it also reduces the risk of blockage whilst enabling a swifter delivery of liquid.

MBL® pipettes comply with international standards for volumetric ware and are available in both Class AS and Class B tolerances. Class AS pipettes are calibrated to the highest grade of accuracy and administer their delivery time (TD, Ex) is swift. They also have a waiting time – this is the time that must be allowed for the meniscus to settle after dispensing, before a reading can be taken. Graduation marks cover at least 90% of the tube perimeter.

This provides the user with a precise and accurate volumetric measurement every time.

Class B pipettes have larger tolerance limits than Class AS, usually twice the volume. They also are calibrated to deliver a (TD, Ex) swift delivery time however; no waiting time is required. The graduations cover between 20% - 40% of the tube perimeter.

MBL® pipettes are calibrated at 20°C to deliver (TD, Ex) within a thermally controlled environment. The calibration accounts for liquid adhesion to the glass when the liquid is released. This only applies however, if the specified waiting times for the reading the scale are adhered to. The tolerances for graduated pipettes conform to ISO 385 and one mark pipettes conform to ISO 648 and DIN 12691 accuracy limits.

Below is an example of how an MBL® pipette is labelled and the information this label provides:

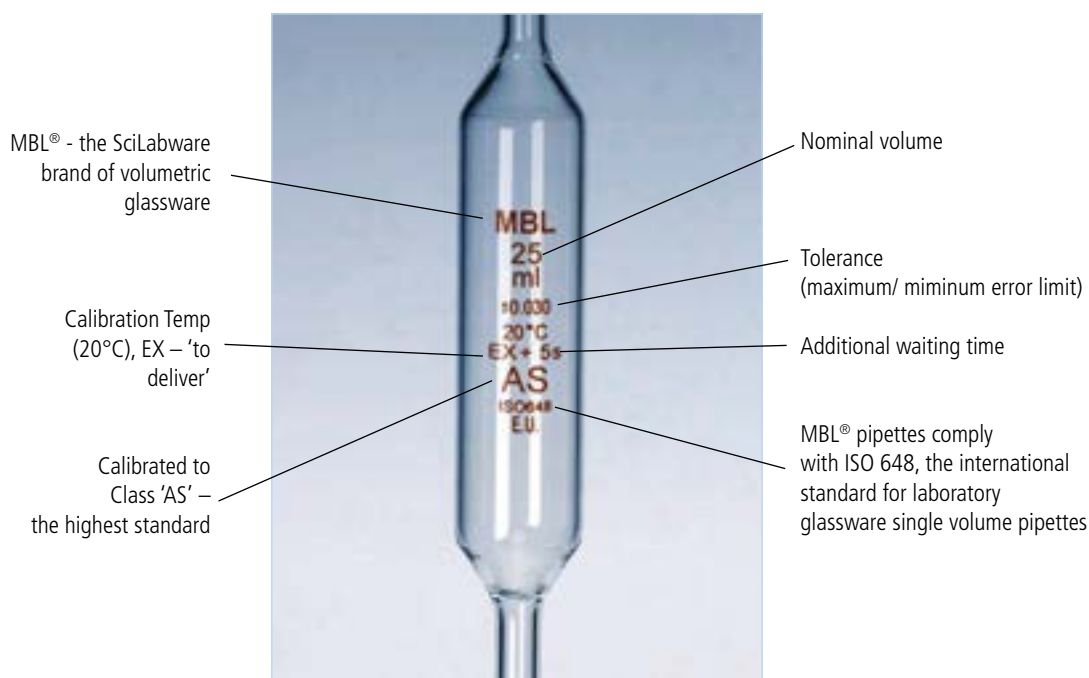

Class AS one mark and graduated pipettes are also inscribed with a batch code. Batch certificates are available to download from [www.scilabware.com/certificates](http://www.scilabware.com/certificates).

We also offer a range of pipette accessories to use in conjunction with MBL® pipettes including pipette fillers, racks and rinsing systems. See pages 217 to 221.



# Technical information - plasticware

## Physical properties and chemical resistance of plastics

These icons provide a quick guide as to the chemical resistance of the polymers and can be found throughout the catalogue where appropriate.



Moderate resistance to common aqueous laboratory chemicals, but avoid organic solvents, strong acids and bases



Excellent resistance to most laboratory chemicals



Good general resistance to a range of laboratory chemicals including acids, bases and some solvents



Can be subjected to autoclaving at 121°C without damage to the polymer.

Please note - where no resistance icon is shown, this product is made from several materials. In this instance please refer to the chemical resistance/physical properties chart for each polymer.

### Polypropylene, PP

- Translucent rigid polymer
- Temperature range -20 to +135°C
- Autoclavable at 121°C
- Good to excellent chemical resistance
- Resistant to fatigue making it tough
- Typically used for beakers, bottles and cylinders



### Polytetrafluoroethylene, PTFE

- Opaque rigid polymer
- Wide temperature range -200 to +260°C
- Autoclavable at 121°C
- Unrivalled resistance to almost all chemicals
- Extremely low friction coefficient
- Typically used for bottles, beakers and stirrers



### Low Density Polyethylene, LDPE

- Translucent flexible polymer
- Narrow temperature range of -50 to +80°C
- Not autoclavable at 121°C
- Good to excellent chemical resistance
- Robust and virtually unbreakable
- Typically used for wash bottles



### Polymethylmethacrylate, Acrylic (PMMA)

- Transparent rigid polymer
- Narrow temperature range -60 to +50°C
- Not autoclavable at 121°C
- Moderate chemical resistance
- Very tough and high clarity
- Typically used for radiation shields



### High Density Polyethylene, HDPE

- Translucent rigid polymer
- Broad temperature range of -100 to +120°C
- Not autoclavable at 121°C
- Good to excellent chemical resistance
- High tensile strength making it very tough
- Typically used for bottles



### Polystyrene, PS

- Transparent rigid polymer
- Narrow temperature range -40 to +90°C
- Not autoclavable at 121°C
- Moderate chemical resistance
- Brittle yet has excellent clarity
- Typically used for container ware



### Polymethylpentene, PMP (TPX)

- Transparent rigid polymer
- Broad temperature range -180 to +145°C
- Autoclavable at 121°C
- Good to excellent chemical resistance
- Has a low density and a high clarity
- Typically used for beakers and cylinders



### Polyvinylchloride, PVC

- Rigid polymer
- Narrow temperature range -25 to +70°C
- Not autoclavable at 121°C
- Moderate chemical resistance
- Rigid or flexible, coloured or clear
- Typically used for trays and troughs



### Polycarbonate, PC

- Transparent rigid polymer
- Broad temperature range -135 to +135°C
- Autoclavable at 121°C
- Moderate chemical resistance
- High impact strength
- Typically used for safety shields

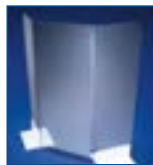

### Polybutylene terephthalate, PBT

- Opaque rigid polymer
- Wide temperature range -40°C to +180°C
- Autoclavable at 121°C
- Mechanically strong engineering polymer
- Good resistance to chemicals
- Typically used for screw caps and connectors



# Technical information - plasticware

## Physical properties of plastics

	LDPE	HDPE	PP	PMP (TPX)	PC	PS	PMMA	PTFE	PBT	
Max usage Temp. °C	80	120†	135	145	135	90	50	260	150	
Min usage Temp. °C	-50	-100	-20††	-180	-135	-40	-60	-200	-40	
Transparency	Translucent	Translucent	Translucent	Clear	Clear	Clear	Clear	Opaque	Opaque	
Flexibility	Flexible	Rigid	Rigid	Rigid	Rigid	Rigid	Rigid	Rigid	Rigid	
Specific Gravity	0.92	0.95	0.9	0.83	1.2	1.05	1.2	2.2	1.31	
Microwaveable	Yes	No	Yes	Yes	Marginal	No	No	Yes	No	
Sterilisation	Autoclavable	No	No	Yes	Yes	Yes	No	No	Yes	Yes
	Gas	Yes	Yes	Yes	Yes	Yes	Yes	No	Yes	Yes
	Dry Heat	No	No	No	Yes	No	No	No	Yes	No
	Radiation (Gamma)	Yes	Yes	No	No	Yes	Yes	Yes	No	Yes
	Disinfection	Yes	Yes	Yes	Yes	Yes	Some	Some	Yes	Yes
Permeability*	N <sub>2</sub>	180	42	48	8,000	50	25	3	Unknown	Unknown
	O <sub>2</sub>	500	185	240	32,000	300	400	12	308	Unknown
	CO <sub>2</sub>	2,700	580	800	115,000	1,075	1,500	68	Unknown	Unknown
Water Absorption (%)	<0.01	<0.03	<0.2	0.01	0.35	0.05	0.35	<0.01	Unknown	
Cytotoxic	No	No	No	No	No	No	No	No	Unknown	

## Food Contact

### Food Contact/Animal Derivative Statement

SciLabware can confirm that in respect to contact of plastic materials with foodstuffs our products, where indicated in the catalogue, comply with one, or both, of the following:

European Regulations (EU) No 10/2011 up to (EU) No 2015/174 relating to plastic materials and articles intended to come into contact with foodstuffs.

Code of Federal Regulation (CFR), Title 21, Food and Drug Administration (FDA), Part 177.1520 "Olefin Polymers", (a) 2)(i) and (c) 2.1 and 2.2.

We can confirm that in respect to Bovine Spongiform Encephalopathy (BSE) / Transmissible Spongiform Encephalopathy (TSE), that our suppliers do not use tallow derived from animal sources in the manufacture of our products.

Please contact us if you require further information. It is the responsibility of the user to ensure that the products are suitable for their intended use.

## REACH

EU Regulation 1907/2006/EC including amendments

Regulation EC no. 1907/2006 of the European Parliament and of the council concerning the Registration, Evaluation, Authorisation and restriction of Chemicals (REACH) is continually being reviewed and updates implemented.

After consultation with the UK Health and Safety Executive (HSE) and Smithers REACH Services (SRS), SciLabware Limited is deemed to be a 'Distributor of Articles' (Finished Products) for laboratory products.

### Laboratory Plastics (Azlon®)

The laboratory plastics we supply are deemed as articles under REACH and therefore require no (Pre-) registration as there is 'no intended release of chemicals from these products'. SciLabware Limited products, to the best of our knowledge and that of our suppliers, do not contain SVHC's above thresholds of 0.1% on a weight/ weight basis.

### Laboratory Glassware (Pyrex®, Quickfit®, and MBL®)

In the framework of the REACH regulation (1907/2006/EC) glass is exempt from registration from Annex V item 11 (Commission Regulation 987/2008/EC) of 8 October 2008 amending Regulation (1907/2006/EC).

### Lipsol® Detergent

We are in constant communication with the manufacturers of Lipsol® to ensure that any relevant REACH (Pre) registration requirements are met. We confirm that Lipsol® does not contain any SVHCs above the threshold of 0.1% on a weight/weight basis and is compliant with REACH.

For full up to date information on REACH, please visit our website <http://www.scilabware.com>.

## Recycling plastics

Although our products are designed for the reusable market you may wish to dispose of them at some point. Therefore here is some advice on recycling of our plastics.

Recycling involves the segregation of plastic products by specific resin types ready for the process of converting them into new raw materials for use in other products.

In order to assist with this segregation, the Society of the Plastics Industry (SPI) had adopted a classification system to identify the seven main types of plastic where each resin is assigned a number.

A large proportion of our products also have the following SPI code permanently moulded into them: -



The seventh classification, or "other" denotes that the product is either not of the preceding plastics or it is a mixture.

SciLabware does not currently supply any products made from PET.

Before recycling any items, please consider the environment and further handling. All items should be washed, cleaned and/or disinfected prior to disposal.

# Technical information - plasticware

## Chemical resistance of plastics

● Excellent resistance: continuous exposure to the substance does not cause damage within 30 days.

	LDPE		HDPE		PP		PMP (TPX)		PVC		PC		PS		SAN		PMMA		PTFE		POM		PBT		
	20	50	20	50	20	50	20	50	20	50	20	50	20	50	20	50	20	50	20	50	20	50	20	50	
Temperature °C																									
Acetaldehyde	●	▲	●	■	■	▲	■	▲	▲	▲	▲	▲	▲	▲	▲	▲	▲	▲	▲	●	●	●	●	□	□
Acetic Acid (Glacial)	■	▲	●	●	●	■	■	●	▲	▲	▲	▲	▲	▲	▲	▲	▲	▲	▲	●	●	▲	▲	▲	□
Acetic Anhydride	▲	▲	■	■	■	■	●	■	▲	▲	▲	▲	▲	▲	▲	▲	▲	▲	▲	●	●	▲	▲	□	□
Acetone	■	▲	▲	▲	■	▲	●	●	▲	▲	▲	▲	▲	▲	▲	▲	▲	▲	▲	●	●	●	●	■	□
Ammonium Chloride (10%)	●	●	●	●	●	●	●	●	■	■	■	■	●	●	●	●	■	■	●	●	□	□	□	□	□
Ammonium Hydroxide (30%)	●	●	●	●	●	●	●	●	▲	▲	■	■	■	■	■	■	■	■	●	●	●	●	□	□	□
Amyl Acetate	■	▲	●	■	■	▲	●	■	▲	▲	▲	▲	▲	▲	▲	▲	▲	▲	●	●	●	●	●	●	□
Aniline (Phenylamine)	●	■	●	●	●	●	●	■	▲	▲	▲	▲	▲	▲	▲	▲	▲	▲	▲	●	●	■	■	■	□
Aqua Regia	▲	▲	▲	▲	▲	▲	▲	▲	▲	▲	▲	▲	▲	▲	▲	■	▲	▲	▲	●	●	●	●	▲	□
Benzaldehyde	●	■	■	▲	▲	■	●	■	▲	▲	▲	▲	▲	▲	▲	▲	▲	▲	▲	●	●	●	●	□	□
Benzene	▲	▲	▲	▲	▲	▲	▲	▲	▲	▲	▲	▲	▲	▲	▲	▲	▲	▲	▲	●	●	●	■	●	□
Benzoic Acid	●	●	●	●	●	■	●	●	■	●	■	■	■	■	●	●	●	●	●	●	□	□	▲	□	□
Boric Acid (10%)	●	●	●	●	●	●	●	●	●	●	●	●	●	●	●	●	●	●	●	●	●	●	●	●	□
Butyl Acetate	■	■	■	■	■	■	■	■	●	▲	▲	▲	▲	▲	▲	▲	▲	▲	▲	●	●	●	■	■	□
Butyric Acid (Butanoic acid)	▲	▲	■	▲	▲	▲	▲	▲	●	▲	▲	▲	▲	▲	▲	▲	▲	▲	▲	●	●	□	□	●	□
Calcium Hydroxide (Saturated)	●	●	●	●	●	●	●	●	●	▲	▲	■	■	●	●	■	▲	●	●	●	●	●	●	●	□
Carbon Disulphide	▲	▲	▲	▲	▲	▲	▲	▲	▲	▲	▲	▲	▲	▲	▲	▲	▲	▲	▲	●	●	●	●	□	□
Carbon Tetrachloride	■	▲	■	▲	■	▲	▲	▲	●	▲	▲	▲	▲	▲	▲	▲	▲	▲	▲	●	●	■	■	□	□
Chloroform	■	▲	■	▲	▲	▲	▲	▲	▲	▲	▲	▲	▲	▲	▲	▲	▲	▲	▲	●	●	▲	▲	▲	□
Citric Acid (1M)	●	●	●	●	●	●	●	●	●	●	●	●	●	●	●	●	●	□	●	●	□	□	□	□	□
Cresol	▲	▲	■	▲	■	■	▲	▲	▲	▲	▲	▲	■	▲	▲	▲	▲	▲	▲	●	●	□	□	▲	□
Cyclohexane	■	▲	■	▲	■	▲	▲	▲	▲	●	■	▲	▲	▲	▲	■	□	●	●	●	●	□	□	□	□
Dibutyl Phthalate	■	▲	■	▲	■	▲	■	▲	▲	▲	▲	▲	▲	▲	▲	▲	▲	▲	▲	●	●	●	●	●	□
Dichlorobenzene	■	▲	■	▲	■	▲	▲	▲	▲	▲	▲	▲	▲	▲	▲	▲	▲	▲	▲	●	●	▲	▲	□	□
Diethyl Ether	▲	▲	■	▲	■	▲	▲	▲	●	▲	▲	▲	▲	▲	▲	▲	▲	▲	▲	●	●	●	●	□	□
Diethylene Glycol	●	●	●	●	●	●	●	■	▲	■	■	●	●	●	●	▲	▲	▲	▲	●	●	●	●	▲	□
Dimethyl Formamide (DMF)	●	●	●	●	●	●	●	▲	▲	▲	▲	▲	▲	▲	▲	▲	▲	▲	▲	●	●	●	●	□	□
Dimethyl Sulfoxide (DMSO)	●	●	●	●	●	●	●	▲	▲	▲	□	■	▲	▲	▲	▲	▲	▲	▲	●	●	□	□	●	□
Dioxane	■	■	■	▲	▲	■	▲	▲	▲	▲	▲	▲	▲	▲	▲	▲	▲	▲	▲	●	■	■	■	▲	□
Ethyl Acetate (Ethyl Ester)	●	●	●	●	■	▲	■	▲	▲	▲	▲	▲	▲	▲	▲	▲	▲	▲	▲	●	●	□	□	▲	□
Ethyl Alcohol (Absolute Ethanol)	●	■	●	●	●	●	■	●	●	●	■	●	■	▲	▲	▲	▲	▲	▲	●	●	●	●	□	□
Ethyl Chloride (Chloroethane)	■	▲	▲	▲	■	▲	▲	▲	▲	▲	▲	▲	▲	▲	▲	▲	▲	▲	▲	●	●	□	□	□	□
Ethylene Chloride	■	▲	▲	▲	■	▲	▲	▲	▲	▲	▲	▲	▲	▲	▲	▲	▲	▲	▲	●	●	▲	▲	□	□
Ethylene Oxide (Pure)	■	■	■	■	■	▲	■	▲	▲	▲	■	▲	▲	▲	▲	▲	▲	▲	▲	●	●	●	●	■	□
Ethylene Oxide (Gas)	■	■	●	●	●	●	■	■	■	■	●	●	●	■	■	■	■	■	■	●	●	□	□	□	□
Formaldehyde (Formalin) 40%	●	■	●	■	●	●	●	●	●	●	■	■	■	■	▲	●	■	■	■	●	●	●	●	□	□
Formic Acid (50%)	■	■	●	●	●	■	●	●	▲	■	■	■	■	■	■	■	□	□	●	●	□	□	■	□	□
Formic Acid (100%)	■	■	●	●	●	■	●	●	▲	■	▲	■	■	■	▲	▲	□	□	●	●	▲	▲	□	□	□
Glycerine (Glycerol)	●	●	●	●	●	●	●	●	●	●	●	●	●	●	●	●	●	●	●	●	●	■	■	●	□

# Technical information - plasticware

 Good resistance; continuous exposure to the substance causes minor damage within 7 - 30 days

 Poor resistance: not suitable for continuous exposure to the substance. Immediate damage may occur

 No information available

	LDPE		HDPE		PP		PMP (TPX)		PVC		PC		PS		SAN		PMMA		PTFE		POM		PBT	
Temperature °C	20	50	20	50	20	50	20	50	20	50	20	50	20	50	20	50	20	50	20	50	20	50	20	50
Hexane	▲	▲	■	■	■	■	■	■	▲	●	▲	■	▲	▲	▲	●	●	●	□	●	●	●	●	□
Hydrobromic Acid (69%)	●	●	■	●	■	●	●	●	●	●	■	■	■	■	■	■	▲	▲	●	●	▲	▲	▲	□
Hydrochloric Acid (5%)	●	●	●	●	●	●	●	●	●	●	●	●	●	●	●	■	□	●	●	▲	▲	▲	▲	□
Hydrochloric Acid (35%)	●	●	●	●	■	●	■	●	■	▲	●	●	●	●	■	▲	▲	●	●	▲	▲	▲	▲	□
Hydrofluoric Acid (48%)	●	●	●	●	■	●	■	■	■	▲	▲	▲	●	■	▲	▲	●	●	▲	▲	▲	■	□	
Hydrogen Peroxide (30%)	●	●	●	●	■	●	■	●	●	●	●	●	■	●	●	■	▲	●	●	●	▲	●	□	
Lactic Acid (85%)	●	●	●	●	■	●	■	●	■	●	■	●	●	●	●	●	●	●	●	●	▲	●	□	
Methyl Acetate	●	▲	●	●	■	■	▲	▲	▲	▲	▲	▲	▲	▲	▲	▲	□	□	●	●	□	□	▲	□
Methyl Alcohol (Methanol)	●	■	●	●	●	●	■	●	●	■	■	■	■	■	▲	▲	▲	▲	●	●	●	●	●	□
Methyl Ethyl Ketone (Butanone)	▲	▲	▲	▲	●	●	●	▲	▲	▲	▲	▲	▲	▲	▲	▲	▲	▲	●	●	□	□	●	□
Methylene Chloride (Dichloro Methane)	▲	▲	●	▲	●	▲	●	▲	▲	▲	▲	▲	▲	▲	▲	▲	▲	▲	●	●	▲	▲	▲	□
Mineral Oil	■	●	●	●	●	■	●	■	●	●	●	●	●	●	●	●	●	●	●	●	●	●	●	□
Nitric Acid (10%)	●	●	■	■	■	■	■	■	■	●	●	■	■	■	■	■	●	□	●	●	▲	▲	■	□
Nitric Acid (70%)	●	▲	●	▲	▲	▲	●	▲	▲	▲	▲	▲	▲	▲	▲	▲	▲	▲	▲	▲	▲	▲	■	□
Nitrobenzene	▲	▲	▲	▲	▲	▲	●	▲	▲	▲	▲	▲	▲	▲	▲	▲	▲	▲	●	●	■	▲	●	□
Oxalic Acid (10%)	●	●	●	●	●	●	●	●	●	●	●	●	●	●	●	●	●	●	●	●	●	●	●	□
Perchloric Acid (70%)	■	▲	■	▲	■	▲	■	▲	■	▲	■	▲	■	▲	■	▲	●	●	■	■	▲	▲	□	□
Phenol (100%)	▲	▲	▲	▲	▲	▲	▲	▲	▲	▲	▲	▲	▲	▲	▲	▲	▲	▲	●	●	▲	▲	▲	□
Phosphoric Acid (85%)	●	▲	●	●	■	●	■	●	■	●	■	●	■	●	■	▲	●	●	●	▲	■	□	□	
Picric Acid	▲	▲	▲	▲	▲	▲	●	▲	▲	▲	▲	■	■	■	■	■	□	□	●	●	□	□	□	□
Potassium Hydroxide (30%)	●	●	●	●	●	●	●	●	●	▲	▲	■	■	●	●	●	●	●	●	●	●	●	▲	□
Potassium Permanganate	●	●	●	●	■	●	●	●	■	●	●	●	■	■	■	■	▲	●	●	■	■	●	□	□
Propylene Glycol	●	●	●	●	●	●	■	■	■	■	■	■	■	■	■	■	□	□	●	●	●	●	□	□
Pyridine	▲	▲	▲	▲	●	●	■	▲	▲	▲	▲	▲	▲	▲	▲	▲	▲	▲	▲	●	●	■	□	□
Salicylic Acid	●	●	●	●	●	●	■	■	●	■	●	■	●	■	■	■	□	□	●	●	▲	▲	●	□
Silver Nitrate	●	■	●	●	●	●	●	●	■	●	●	●	●	●	■	■	□	□	●	●	■	■	□	□
Sodium Hydroxide (50%)	■	■	●	●	●	●	●	●	▲	▲	●	■	●	■	●	▲	●	●	●	●	▲	●	▲	□
Sodium Hypochlorite (15%)	●	■	●	■	■	▲	●	●	●	■	■	●	■	●	●	●	●	●	●	□	□	▲	□	□
Sulphuric Acid (20%)	●	●	●	●	●	●	●	●	■	●	■	●	●	●	■	●	●	●	●	□	□	□	□	□
Sulphuric Acid (60%)	●	■	■	■	■	■	■	■	■	■	■	■	■	■	▲	▲	▲	▲	●	●	▲	▲	□	□
Sulphuric Acid (98%)	■	■	■	■	■	■	■	■	▲	▲	▲	▲	▲	▲	▲	▲	▲	▲	●	●	▲	▲	▲	□
Tetrahydrofuran (THF)	■	▲	■	●	■	■	■	■	▲	▲	▲	▲	▲	▲	▲	▲	▲	▲	●	●	■	■	●	□
Toluene	■	▲	▲	▲	▲	▲	■	▲	▲	▲	▲	▲	▲	▲	▲	▲	▲	▲	●	●	▲	▲	●	□
Trichloroacetic Acid	■	▲	■	■	■	■	■	■	▲	▲	▲	▲	▲	▲	▲	▲	□	□	●	●	□	□	▲	□
Trichloroethylene	▲	▲	▲	▲	▲	▲	▲	▲	▲	▲	▲	▲	▲	▲	▲	▲	▲	▲	●	●	▲	▲	▲	▲
Turpentine	■	▲	■	■	■	■	■	■	■	■	■	■	■	■	■	■	■	▲	●	●	●	●	□	□
Xylene	▲	▲	■	▲	▲	■	▲	▲	▲	▲	▲	▲	▲	▲	▲	▲	▲	▲	●	●	●	▲	□	□
Zinc Chloride (10%)	●	●	●	●	●	●	●	●	●	●	●	●	●	●	●	●	●	●	●	●	■	●	□	□
Zinc Sulphate (10%)	●	●	●	●	●	●	●	●	●	●	●	●	●	●	●	●	●	●	●	■	▲	□	□	□

This chart gives general guidelines only on the chemical resistance of plastics. There are many factors that influence chemical resistance, we therefore recommend that you test for your own application before selecting the appropriate Azlon® product. If you have any doubts please contact SciLabware for assistance.

# Technical information - plasticware

## Care and maintenance of laboratory plasticware

The following guidelines are provided to ensure your plastic laboratory-ware is maintained in the best possible condition.

These guidelines are not definitive and care must be taken as each polymer has its own unique properties. Please also consult the chemical and physical properties charts in this catalogue. If you are still unsure e-mail [azlon@scilabware.com](mailto:azlon@scilabware.com) for advice.

### General Precautions

- Chemicals can adversely affect the performance of laboratory plasticware resulting in cracking, loss of strength and flexibility etc.
- If in any doubt, note the type of polymer the product is manufactured from, the chemical that is to be used, then confirm compatibility by checking against the chemical resistance chart. (See pages xxx-xxx).

### Washing and cleaning

- Most laboratory plasticware is readily cleaned in warm water with a detergent and soft cloth or sponge.
- Avoid using abrasive cleaners or scouring pads which can result in surfaces becoming scratched.
- A low or non-alkaline detergent is suitable for cleaning most plasticware.  
Note however that polystyrene and polycarbonate products are susceptible to attack by alkalis and a neutral detergent is recommended.
- If using an automatic laboratory washing machine to wash plastic volumetric ware, such as measuring cylinders, employ a wash temperature below 60°C. High temperatures can affect volumetric accuracy.
- Ultrasonic baths may be used for cleaning plasticware. However do take care that the products do not directly touch the transducer membrane.

### Heating

- Never place plasticware in direct contact with a flame or place onto a hotplate surface.
- Most plastics allow the transmission of microwaves.  
However, as with any microwave vessel, be sure it holds a microwave absorbing material, such as water, before placing in the oven.

### Sterilisation

- If the plasticware is to be sterilised by autoclaving always pre-check that the polymer can withstand repeated exposure to temperatures of 121°C.
- Azlon® plastic products that are autoclavable are identified by an *A* symbol in this catalogue.
- When autoclaving bottles always ensure the caps are loosened or removed to prevent accidental collapse or deformation.

### Disposal

- If the disposal of an item of plasticware is unavoidable, always follow local laws and regulations.  
Where reclamation facilities are offered it can be helpful to segregate the products by polymer type: many Azlon® products are marked with an SPI code to help identification.

### Frequently Asked Questions (FAQs)

- For answers to frequently asked questions please visit [www.scilabware.com/FAQ/default.asp](http://www.scilabware.com/FAQ/default.asp)

## A

Adapters	
cone/screwthread	14
expansion	14
multiple necks	16
Perkin	20
receivers	17 - 20
reduction	15
reduction, PTFE	15
splash head	21, 22
steam distillation head	22
still head	23, 24
stopcock	24, 25
swan neck	17
SVL® cone/screwthread	262
thermometer	271
tubing	25, 26
Ampoule breakers	26
Arsenic determination apparatus	27
Aspirators	
glass	27 - 29
plastic	30, 31
Automatic burettes	92, 93

## B

Baffle flasks	142, 143
Bags, autoclave	33
Balers	34
Basket	34
Beakers, glass	
conical	38
heavy-duty	37, 38
jacketed	38
low form	36, 37
tall form	37, 38
Beakers, plastic	
medicine	106
PMP (TPX)	42
polypropylene	39 - 42
PTFE	43
Beta radiation shields	226
Bibbette® pipette filler	218
Bins	
glass disposal	43
incineration	43
Boards, cutting	110
Boiling flasks	134, 135
Bottle carriers	83
Bottles, glass	
amber	48, 56
density	57
Dreschel	192, 193
dropping	58
media-lab	44 - 49
plastic coated	48
reagent	53 - 56
roller	57

square	49
weighing	286
Bottles, plastic	
bulk pack	60-62, 65, 68
aspirator	30, 31
carboy	32, 33
dispensing	64
Driplok®	73, 75
graduated	59, 69
gram staining	76
HDPE	61, 62, 68 - 70
LDPE	62 - 64, 73 - 80
narrow neck	58 - 63
polycarbonate	58, 59
polypropylene	60, 65 - 67, 81
powder	67
PTFE	70
tracker	76
wash	73 - 81
wide neck	65 - 70
Boxes	
airtight	84
sterilising	220
Bubblers	84, 85
Büchner	
flasks	145 - 147
funnels	178 - 180
Buckets	
HDPE	86
ice	194
Bulb pipettes	210 - 212
Burettes	
acrylic	94
automatic zero	92 - 94
class AS, works certified	87
class AS	87, 88, 90, 92, 93
class B	88 - 94
modular	90
Rotaflo®	89, 91
Schellbach	88, 90, 93
Sofnol, auto zero	91, 92
stopcocks	249, 251

## C

Caps	
bottle	49, 50, 52, 54
culture flask closures	144
Quickfit®	206
SVL®	262
Carboys	32, 33
Centrifuge tubes	275, 276
Chemistry sets	228 - 231
Chromatography column	95, 96
Clamps	
burette	97
tubing	97

Claisen	
head	23
flasks	152
Cleaning, Lipsol detergent	97
Clips	
conical joints	200
flat flange joints	201
spherical joints	203, 205
Cold trap	98
Condensers	
air	98
Allihn	98, 99
coil	99, 100, 101
cold finger	101
cold trap	98
Davies	102
distillation apparatus	103
ether	102
inland revenue	103
jacketed coil	101
Liebig	103
multi-coil	100
twin-coil	100
Cones	
Imhoff sedimentation	195
Quickfit®	196 - 198
Conical beakers	38
Conical flasks	136 - 141
Connectors	
non-return valves	105
screwthread	104
tubing	104, 105
Containers	106 - 108
Crow receiver	117
Crucibles	
adapter	109
Gooch	109
Crystallising dishes	124
Culture tubes	277
Culture flasks	142 - 144, 158
Culture vessels	160
Cutting board	110
Cylinders, glass	
class A, works certified	111, 115
class A	111, 115
class B	112 - 114, 116, 117
heavy-duty	113
mixing	115 - 117
Nessler	117
plastic foot	114, 117
stoppered	115 - 117
Cylinders, plastic	
class A	118
class B	118 - 120
squat form	120



# Index by product name

- D**
- Dean and Stark .....285
  - Delivery tubes .....280
  - Density bottles .....57
  - Desiccators
    - cabinet .....123
    - non-vacuum .....121
    - vacuum .....121, 122
    - polycarbonate .....122
    - polystyrene .....123
  - Detergent, Lipsol .....97
  - Developing dishes .....272
  - Digestion tubes .....278
  - Dilatometer .....123
  - Dishes
    - crystallising .....124
    - evaporating .....125
    - general purpose .....125
    - mortar .....126
    - pestle .....126
    - petri .....126
    - photographic .....272
  - Dispensing bottles
    - pivot nozzle .....64
  - Dispensers, tilt measure .....127
  - Disposal bins .....43
  - Distillation flasks .....145
  - Distillation head .....172
  - Draining racks .....223
  - Dreschel bottles .....192, 193
  - Dropping
    - bottles .....58
    - funnels .....182 - 185
    - pipettes .....56, 217
  - Drying tubes .....278, 279
  - Dufton columns .....172
- E**
- Erlenmeyer flasks
    - heavy duty .....137, 138
    - narrow neck .....136, 137
    - Quickfit® .....139 - 141
    - screwcap .....138
    - wide neck .....137, 138
    - plastic .....141
  - Evaporating dishes .....125
  - Evaporating flasks .....150
  - Expansion adaptors .....14
  - Extractors
    - glass thimbles .....129
    - plain body .....128
    - Soxhlet .....127, 128, 130
- F**
- Fermentation vessels .....160
  - Fernbach flasks .....144
  - Filtration
    - discs .....131
    - rubber cones .....110
    - flasks .....145 - 147
    - funnels .....177 - 181
    - Gooch .....109
    - membrane .....132, 133
    - pump .....133
    - system .....133
    - tubes .....279
  - Finger/hand protectors .....225
  - Flask stand .....155
  - Flasks
    - amber volumetric .....163, 165
    - baffled .....142 - 144
    - boiling .....134, 135
    - Büchner .....145, 146, 147
    - Claisen .....152
    - conical .....136 - 141
    - culture .....142 - 144
    - cylindrical .....144
    - distillation .....145
    - Erlenmeyer flasks .....136 - 141
    - evaporating .....150
    - extraction .....135
    - Fernbach .....144
    - filter .....145 - 147
    - flat bottom .....134, 149, 150
    - Florentine .....150
    - heavy-duty .....137, 138
    - Iodine .....147
    - jacketed .....159, 266
    - Kjeldahl .....148
    - Kohlrausch .....170
    - multi neck .....151, 152, 156 - 158
    - pear shaped .....151, 152
    - reaction .....159, 266
    - rotary evaporator .....150
    - round bottom .....135, 150, 154 - 156
    - Roux culture .....158
    - volumetric .....162 - 169
  - Flat flange
    - flasks .....159, 160
    - joints .....201
    - seals .....161, 202
  - Flow indicator .....170
  - Forceps .....284
  - Fractionation
    - column packing .....171
    - column packing support .....171
    - columns .....170 - 172
    - distillation head .....172
    - Dufton .....172
    - plain .....170
    - Vigreux .....171
  - Funnels
    - Büchner .....178 - 180
    - dropping .....182 - 185
    - filter .....176 - 182
    - general purpose .....173, 174
    - industrial .....174
    - membrane filter .....132, 133
    - powder .....175
    - pressure equalising .....186, 187
    - separating .....187 - 192
    - thistle .....176
    - vacuum .....180, 181
- G**
- Gallipots .....106
  - Gas
    - bubblers .....84, 85
    - delivery tubes .....280
    - distribution tubes .....279
    - wash bottles .....192, 193
  - GLS80 bottles .....44, 45
  - Gooch crucibles .....109
  - Graduated pipettes .....212 - 216
  - Gram staining bottles .....76
- H**
- Hand/finger protectors .....225
  - Heavy-duty
    - beakers .....37
    - cylinders .....113
    - flasks .....137, 138
  - Hand pumps .....221, 222
- I**
- Ice bucket .....194
  - Imhoff sedimentation cone .....195
  - Incineration bins .....43
  - Inland revenue condensers .....103
  - Instrument tray .....272
  - Integral washbottle .....80
  - Iodine flasks .....147
- J**
- Jacketed
    - beakers .....38
    - condensers .....101
    - flasks .....159, 266
  - Jar, slide staining .....233
  - Jerrycans .....196
  - Joint clips
    - conical .....200
    - flat flange .....201
    - spherical .....203, 205
  - Joints
    - cones .....196 - 198
    - flat flange .....201
    - Rotulex® .....204, 205
    - screwthread .....205, 206
    - sockets .....198
    - sleeves, PTFE .....199
    - spherical .....202 - 204
    - SVL® .....260 - 264
    - Torion .....263, 264

- Jugs  
polypropylene.....207
- K**
- Keys, stopcock  
glass.....253  
GP Rotaflo®.....250  
HP Rotaflo®.....248  
PTFE.....252
- Kipps measure .....127
- Kits  
organic chemistry..... 228 - 231  
slide staining.....233
- Kjeldahl flasks.....148
- Kohlrausch flasks .....170
- L**
- Liebig condenser .....103
- Lipsol detergent ..... 97
- M**
- Magnetic stirrer bars..... 235 - 240
- Magnetic retrievers.....241
- Markham still.....208
- Medicine measures.....106
- Measuring cylinders..... 111 - 120
- Measuring scoops.....227
- Media-lab bottles..... 44 - 49
- Membrane filters.....132, 133
- Mercury collector.....227
- Microcentrifuge racks..... 115 - 117
- Microscope slide staining kit.....233
- Microscope slide staining jar.....233
- Mixing cylinders..... 115 - 117
- N**
- Nessler cylinders .....117
- Nitrogen determination  
distillation unit.....208  
Kjeldahl assembly.....208  
Kjeldahl flasks.....148
- Non-return valves .....105
- O**
- One-mark pipettes .....210, 211
- Organic chemistry kit ..... 228 - 231
- P**
- Petri dishes, glass.....126
- Petri dishes, stand .....234
- Perkin adapter.....20
- Pear shaped flasks .....151, 152
- Photographic dish.....272
- Pipette fillers  
Bibbette®.....218  
rubber.....218
- Pipette rack.....219
- Pipette rinsing.....219, 220
- Pipette stand.....220
- Pipette sterilising box.....220
- Pipette support .....221
- Pipettes  
class AS, works certified .....210, 212, 214  
class AS..... 210, 212 - 214  
class B.....211, 213, 215, 216  
dropping.....217  
graduated.....212 - 216  
one-mark.....210, 211  
Pasteur.....217  
serological.....216  
two-mark.....212
- Pneumatic troughs.....272
- Pouring rings for media-lab bottles.....50
- Powder funnels .....175
- Precision thermometers .....270
- Pressure equalising funnels.....186, 187
- PTFE  
beakers.....43  
bottles.....70  
joint sleeves.....199  
magnetic stirring bars..... 235 - 240  
seals.....161, 202  
stopcocks..... 250 - 252
- Pumps  
barrel.....221  
filter.....133  
general purpose.....222  
water jet.....222
- Q**
- Quickfit® sets ..... 228 - 231
- R**
- Racks  
draining.....223  
microcentrifuge.....225  
test tube.....224
- Radiation shields.....226
- Raschig rings.....171
- Reaction bubblers .....84, 85
- Reaction flasks.....159, 266
- Receivers, adapters ..... 17 - 20, 117
- Reduction adapters.....15
- Reaction bubblers .....84, 85
- Reagent bottles.....53 - 56
- Retaining clips .....161
- Retort stand.....235
- Retrievers, magnetic.....241
- Rinsing system, pipette.....219, 220
- Rods, stirring.....246
- Roller bottles.....57
- Rotaflo®  
adapters.....24, 25  
burettes.....89, 91  
dropping funnels.....183, 184  
separating funnels.....189, 190  
stopcocks.....247 - 250
- Rotary evaporator flasks.....150
- Rotary evaporator splash heads.....22
- Rotulex® joints.....204, 205
- Round bottom flasks.....135, 150, 154 - 159
- Roux culture flasks.....158
- Rubber cones .....110
- S**
- Safety  
beta radiation.....226  
shields.....226  
hand/finger protectors.....225
- Scoops  
plastic.....227  
weighing.....286
- Screwcaps  
bottle.....49, 50, 52, 54  
bottle pouter.....53  
connection system.....51, 52  
membrane.....52  
Quickfit®.....206  
SVL®.....262
- screw thread connectors.....104
- Sedimentation cone.....195
- Semi-micro filter receivers.....182
- Separating funnels.....187 - 192
- Serological pipettes.....216
- Sets .....228 - 231
- Shields, beta radiation.....226
- Shield, safety.....226
- Sintered discs.....131
- Siphon pumps.....133, 221, 222
- Sleeves, joint.....199
- Slide staining jar.....233
- Slide staining kit.....233
- Sockets.....198
- Sofnol burettes.....91, 92
- Solvent still heads.....24
- Soxhlet extractors.....127, 128, 130
- Spatulas, polypropylene.....234
- Specimen containers.....108
- Spherical joints.....202 - 204
- Splash head adapters.....21, 22
- Spotting tile.....234
- Stand, petri dish.....234
- Stand, retort.....235
- Sterilising boxes.....220
- Sterilising trough.....273
- Still heads.....23, 24
- Stirrers  
bars, magnetic.....235 - 240  
bearings.....244, 245  
blades.....242, 243  
glands.....245  
guides.....244  
rods.....246  
shafts.....241, 242 - 244

# Index by product name

---

- Stopcocks  
adapters .....24, 25  
aspirator..... 27 - 33  
burette repair .....249, 251  
funnel repair.....251  
glass key..... 251 - 254  
high vacuum.....253, 254  
plastic.....255, 256  
PTFE ..... 250 - 252  
Rotaflo® ..... 247 - 250  
SVL® Torion.....263, 264
- Stoppers  
glass..... 256 - 258  
plastic.....258
- SVL® glassware ..... 259 - 268
- Swan neck adapter .....17
- T**
- Test tube basket .....34  
Test tube rack.....224  
Test tubes..... 280 - 283
- Thermometers  
adapter.....271  
Bee-ka.....271  
general purpose .....269, 270  
pocket .....271  
precision.....270  
Quickfit®.....270
- Thistle funnel .....176
- Tile, spotting .....234
- Tongue depressors .....234
- Thorpe condenser.....103
- Tilt measure dispensers.....119
- Traps, cold.....101
- Torion joints .....263, 264
- Trays .....272
- Troughs .....272, 273
- Tubes  
air/steam inlet .....274  
centrifuge.....275, 276  
culture.....277  
digestion .....278  
drying.....278, 279  
test..... 280 - 283
- Tubing  
adapters .....25, 26  
clamps.....97
- Tweezers .....284
- Two-mark pipettes .....212
- V**
- Vacuum  
desiccators .....121, 122  
flask ..... 141, 145 - 147  
pump.....133, 222  
stopcocks ..... 247, 248, 253, 254
- Valve, non-return .....105
- Vigreux  
column .....171  
flasks.....152
- Volumetric flasks..... 162 - 169
- W**
- Wall mountable draining rack.....223
- Wash bottles  
coloured .....79  
custom DIY .....75  
DripLok® venting..... 73, 75 - 77  
gas .....192, 193  
gram staining .....76  
tracker .....76
- Waste bins  
broken glass .....43  
incineration .....43
- Watch glasses .....284
- Water jet pump .....133, 222
- Water Estimators.....285
- Weighing  
bottles .....286  
scoop.....286

## 1

10/050/10 .....	270	1070/42D .....	134	1137/11M .....	138	1471/02M .....	124
1000/02M .....	36	1080/02M .....	134	1137/12M .....	138	1471/03M .....	124
1000/03M .....	36	1080/04M .....	134	1137/13M .....	138	1471/04M .....	124
1000/04D .....	36	1080/08D .....	134	1137/14M .....	138	1471/08M .....	124
1000/05M .....	36	1080/10D .....	134	1137/18M .....	138	1471/10M .....	124
1000/06D .....	36	1080/12D .....	134	1138/10 .....	144	1471/12M .....	124
1000/10D .....	36	1080/14D .....	134	1139/10 .....	144	1471/16M .....	124
1000/11M .....	36	1100/02M .....	135	1140/02M .....	137	1480/02D .....	126
1000/14D .....	36	1100/04M .....	135	1140/04D .....	137	1480/06D .....	126
1000/18D .....	36	1100/12D .....	135	1140/08D .....	137	1480/08D .....	126
1000/20D .....	36	1100/18D .....	135	1140/10D .....	137	1480/10D .....	126
1000/22D .....	36	1100/24D .....	135	1140/14D .....	137	1480/12D .....	126
1000/28D .....	36	1100/28D .....	135	1140/18D .....	137	1490/02 .....	125
1000/30D .....	36	1100/32D .....	135	1141/08 .....	143	1490/04 .....	125
1000/34D .....	36	1100/35D .....	135	1141/10 .....	143	1490/06 .....	125
1000/38D .....	36	1100/36D .....	135	1141/12 .....	143	1490/08 .....	125
1003-150 .....	37	1100/38D .....	135	1141/14 .....	143	1515/01D .....	53
1003-1L .....	37	1120/04M .....	135	1142/08 .....	142	1515/02D .....	53
1003-250 .....	37	1120/08D .....	135	1142/10 .....	142	1515/04D .....	53
1003-2L .....	37	1120/14D .....	135	1142/12 .....	142	1515/06D .....	53
1003-3L .....	37	1120/18D .....	135	1142/14 .....	142	1515/08D .....	53
1003-400 .....	37	1120/22D .....	135	1170/02M .....	145	1515/10D .....	53
1003-4L .....	37	1120/26D .....	135	1170/02SC .....	146	1515/12D .....	53
1003-5L .....	37	1120/29D .....	135	1170/04M .....	145	1515/16D .....	53
1003-600 .....	37	1130/02M .....	136	1170/04SC .....	146	1515/18D .....	53
1004-150 .....	38	1130/03 .....	136	1170/06M .....	145	1515/20D .....	53
1004-250 .....	38	1130/05M .....	136	1170/06SC .....	146	1515/22D .....	53
1004-600 .....	38	1130/06D .....	136	1170/08M .....	145	1516/01D .....	46
100RASX .....	130	1130/08D .....	136	1170/08SC .....	146	1516/01RED .....	47
1015/02M .....	37	1130/10D .....	136	1170/10D .....	145	1516/02D .....	46
1015/04D .....	37	1130/11M .....	136	1170/10SC .....	146	1516/02RED .....	47
1015/06D .....	37	1130/12D .....	136	1170/12M .....	145	1516/04D .....	46
1015/10D .....	37	1130/14D .....	136	1170/14D .....	145	1516/04RED .....	47
1015/14D .....	37	1130/16D .....	136	1170/14SC .....	146	1516/05D .....	46
1015/18D .....	37	1130/20D .....	136	1190/02M .....	144	1516/06D .....	46
1015/22D .....	37	1130/26D .....	136	1190/04M .....	144	1516/06RED .....	47
1015/26D .....	37	1130/30D .....	136	1190/06M .....	144	1516/08D .....	46
1020/06D .....	38	1130/32D .....	136	1200/04M .....	148	1516/08RED .....	47
1020/16D .....	38	1130/36D .....	136	1200/10D .....	148	1516/09D .....	46
1025/10SC .....	38	1132/02 .....	139	1200/12D .....	148	1516/10D .....	46
1025/18SC .....	38	1132/06 .....	139	1200/16M .....	148	1516/10RED .....	47
1025/22SC .....	38	1132/14 .....	139	1280/14M .....	145	1516/12D .....	46
1025/28SC .....	38	1132/15 .....	139	1290/04M .....	145	1516/12RED .....	47
1060/04D .....	284	1132/20 .....	139	1290/06M .....	145	1516/14D .....	46
1060/06D .....	284	1132/26 .....	139	1350/04M .....	158	1516/16D .....	46
1060/09D .....	284	1133/02 .....	139	1350/06M .....	158	1516/18D .....	46
1060/10D .....	284	1133/06 .....	139	1450/01D .....	125	1516/20D .....	46
1060/14D .....	284	1133/14 .....	139	1450/03D .....	125	1516/22D .....	46
1060/18D .....	284	1133/20 .....	139	1450/04D .....	125	1518/04 .....	48
1060/20D .....	284	1133/26 .....	139	1450/06D .....	125	1518/06 .....	48
1060/21D .....	284	1134/08 .....	142	1450/10D .....	125	1518/08 .....	48
1060/24D .....	284	1134/10 .....	142	1450/14D .....	125	1518/10 .....	48
1070/02M .....	134	1134/12 .....	142	1470/00M .....	124	1518/12 .....	48
1070/04D .....	134	1134/14 .....	142	1470/01M .....	124	1518/16 .....	48
1070/12D .....	134	1135/14D .....	143	1470/02D .....	124	1518/18 .....	48
1070/18D .....	134	1135/20D .....	143	1470/03M .....	124	1519/01 .....	48
1070/24D .....	134	1135/26D .....	143	1470/04D .....	124	1519/02 .....	48
1070/28D .....	134	1135/30D .....	143	1470/08D .....	124	1519/04 .....	48
1070/32D .....	134	1137/02M .....	138	1470/10D .....	124	1519/06 .....	48
1070/36D .....	134	1137/03D .....	138	1470/12D .....	124	1519/08 .....	48
1070/38D .....	134	1137/06M .....	138	1470/16D .....	124	1519/10 .....	48
1070/40D .....	134	1137/08D .....	138	1471/00M .....	124	1519/12 .....	48
		1137/10M .....	138	1471/01M .....	124	1519/16 .....	48



3151/02	164	3201/10	111	3295/18AS	87	3700/10	178
3151/02WC	162	3201/10WC	111	3295/22ASWC	87	3710/01	179
3151/04	164	3201/12	111	3295/24ASWC	87	3710/02	179
3151/04WC	162	3201/12WC	111	3295/26ASWC	87	3710/04	179
3151/06	164	3201/14	111	3295/28ASWC	87	3710/06	179
3151/06WC	162	3201/14WC	111	3296/02AS	92	3710/08	179
3151/08	164	3201/16	111	3296/04AS	92	3710/10	179
3151/08WC	162	3201/16WC	111	3296/06AS	92	3720/02M	179
3151/10	164	3201/18	111	3297/12	94	3720/04M	179
3151/10WC	162	3201/18WC	111	3297/14AS	94	3720/06M	179
3151/12	164	3205/04MP	114	3298/02	91	3720/08M	179
3151/12WC	162	3205/06MP	114	3298/03	91	3722/02M	179
3151/14	164	3205/08P	114	3298/04	91	3722/04M	179
3151/14WC	162	3205/10P	114	3299/04	91	3722/06M	179
3151/16	164	3205/12P	114	3299/06	91	3722/08M	179
3151/16WC	162	3211/04MP	116	3396/02AS	93	3730/04	176
3151/18	164	3211/06MP	116	3396/04AS	93	3730/06	176
3151/18WC	162	3211/08MP	116	3396/06AS	93	3730/08	176
3151/20	164	3211/10MP	116	3400/04	117	3750/03	176
3151/20WC	162	3211/12MP	116	3440/02M	276	3760/02	177
3151/22	164	3211/14MP	116	3450/02MP	276	3760/04	177
3151/22WC	162	3211/16MP	116	3460/02M	275	3760/06	177
3151/24	164	3211/18MP	116	3496/02AS	93	3766/03	181
3151/24WC	162	3212/04	115	3496/04AS	93	3770/02	177
3151/26	164	3212/04WC	115	3496/06AS	93	3770/04	177
3151/26WC	162	3212/06	115	3590/01	184	3770/06	177
3152/04A	165	3212/06WC	115	3590/02	184	3770/08	177
3152/04AWC	163	3212/08	115	3590/04	184	3770/10	177
3152/06A	165	3212/08WC	115	3590/06	184	3775/02M	95
3152/06AWC	163	3212/10	115	3590/08	184	3780/02M	177
3152/08A	165	3212/10WC	115	3620/02	178	3780/04M	177
3152/08AWC	163	3212/12	115	3620/04	178	3780/06M	177
3152/10A	165	3212/12WC	115	3620/06	178	3780/08M	177
3152/10AWC	163	3212/14	115	3620/08	178	3830/00M	279
3152/12A	165	3212/14WC	115	3620/10	178	3830/02M	279
3152/12AWC	163	3212/16	115	3630/01	178	3830/04M	279
3152/14A	165	3212/16WC	115	3630/02	178	3830/06M	279
3152/14AWC	163	3212/18	115	3630/04	178	3840/02M	129
3152/16A	165	3212/18WC	115	3630/06	178	3845/02M	129
3152/16AWC	163	3215/06MP	117	3630/08	178		
3152/18A	165	3215/08P	117	3630/10	178		
3152/18AWC	163	3215/10P	117	3650/02M	109	40023	97
3152/20A	165	3215/12P	117	3650/04M	109	40RASX	130
3152/20AWC	163	3280-100	113	3650/06M	109	443038N	188
3152/22A	165	3280-1L	113	3650/08M	109	443039N	192
3152/22AWC	163	3280-250	113	3660/02M	109	443042N	188
3200/02MP	112	3280-2L	113	3660/04M	109	443043N	192
3200/04MP	112	3280-50	113	3660/06M	109	443047N	188
3200/06MP	112	3280-500	113	3660/08M	109	443048N	192
3200/08MP	112	3285-10	113	3660/10M	109	443054N	188
3200/10MP	112	3285-100	113	3680/02M	109	443055N	192
3200/12MP	112	3285-1L	113	3680/04M	109	443060N	188
3200/14MP	112	3285-25	113	3680/06M	109	443061N	192
3200/16MP	112	3285-250	113	3680/08M	109	443065N	188
3200/18MP	112	3285-50	113	3680/10M	109	443066N	192
3201/02	111	3285-500	113	3690/02M	109	443073N	188
3201/02WC	111	3295/02	88	3690/04M	109	443074N	192
3201/04	111	3295/04	88	3690/08M	109	443333	183
3201/04WC	111	3295/06	88	3700/01	178	443334	185
3201/06	111	3295/08	88	3700/02	178	443340	183
3201/06WC	111	3295/12AS	87	3700/04	178	443341	185
3201/08	111	3295/14AS	87	3700/06	178	443347	183
3201/08WC	111	3295/16AS	87	3700/08	178	443348	185



BGC430P.....	67	BLH0100BULK.....	68	BNP0500P.....	60	BRE002.....	57
BGC432P.....	67	BLH0100P.....	68	BNP05A.....	30	BRE004.....	57
BGC436P.....	67	BLH0125BULK.....	68	BNP05B.....	32	BRE006.....	57
BGC440P.....	67	BLH0125P.....	68	BNP1000BULK.....	60	BRF056.....	58
BGE212P.....	69	BLH0150BULK.....	68	BNP1000P.....	60	BSC0250.....	58
BGE218P.....	69	BLH0150P.....	68	BNP10A.....	30	BSC0500.....	58
BGE224P.....	69	BLP0100BULK.....	65	BNP10B.....	32	BSC1000.....	58
BGE230P.....	69	BLP0100P.....	65	BNP2000BULK.....	60	BSC2000.....	58
BGE236P.....	69	BLP0125BULK.....	65	BNP2000P.....	60	BSH05A.....	31
BGE240P.....	69	BLP0125P.....	65	BNP20A.....	30	BSH05B.....	33
BGE242P.....	69	BLP0125PGRAD.....	67	BNP20B.....	32	BSH10A.....	31
BGE336P.....	69	BLP0150BULK.....	65	BPB0025P.....	40	BSH10B.....	33
BGE340P.....	69	BLP0150P.....	65	BPB0050P.....	40	BSH20A.....	31
BGE342P.....	69	BLP0150PGRAD.....	67	BPB0100P.....	40	BSH20B.....	33
BGE424P.....	70	BNH0030BULK.....	61	BPB0250P.....	40	BSH30A.....	31
BGE426P.....	70	BNH0030PN.....	61	BPB0400P.....	40	BSH30B.....	33
BGE430P.....	70	BNH0060BULK.....	61	BPB0500P.....	40	BSR0100BULK.....	62
BGE436P.....	70	BNH0060PN.....	61	BPB0600P.....	40	BSR0100P.....	62
BGE439P.....	70	BNH0100BULK.....	61	BPB1000P.....	40	BSR0250BULK.....	62
BGE441P.....	70	BNH0100PN.....	61	BPB2000P.....	40	BSR0250P.....	62
BGE514P.....	64	BNH0125BULK.....	61	BPB3000P.....	40	BSR0500BULK.....	62
BGE520P.....	64	BNH0125PN.....	61	BPB5000P.....	40	BSR0500P.....	62
BGE528P.....	64	BNH0150BULK.....	61	BPM0025P.....	41	BSR1000BULK.....	62
BGE530P.....	64	BNH0150PN.....	61	BPM0050P.....	41	BSR1000P.....	62
BGE536P.....	64	BNH0250BULK.....	61	BPM0100P.....	41	BWH0030BULK.....	68
BGE814PNC.....	64	BNH0250P.....	61	BPM0250P.....	41	BWH0030PN.....	68
BGE820PNC.....	64	BNH0500BULK.....	61	BPM0400P.....	41	BWH0060BULK.....	68
BGE828PNC.....	64	BNH0500P.....	61	BPM0500P.....	41	BWH0060PN.....	68
BGE830PNC.....	64	BNH1000BULK.....	61	BPM0600P.....	41	BWH0250BULK.....	68
BGE836PNC.....	64	BNH1000P.....	61	BPM1000P.....	41	BWH0250PN.....	68
BGF130P.....	80	BNH2000BULK.....	61	BPM2000P.....	41	BWH0500BULK.....	68
BGF136P.....	80	BNH2000P.....	61	BPM3000P.....	41	BWH0500PN.....	68
BGG302.....	108	BNL0030BULK.....	63	BPM5000P.....	41	BWH1000BULK.....	68
BGG304.....	108	BNL0030PN.....	63	BPP002.....	217	BWH1000PN.....	68
BGG306.....	108	BNL0060BULK.....	63	BPP004.....	217	BWH2000BULK.....	68
BGG308.....	108	BNL0060PN.....	63	BRB004.....	92	BWH2000P.....	68
BGG311.....	108	BNL0100BULK.....	63	BRB006.....	92	BWK004.....	34
BGG312.....	108	BNL0100PN.....	63	BRB042.....	92	BWK006.....	34
BGG440P.....	108	BNL0125BULK.....	63	BRB050P.....	91	BWK009.....	34
BGG442P.....	108	BNL0125PN.....	63	BRB056P.....	91	BWN008.....	43
BGG444P.....	108	BNL0150BULK.....	63	BRB058P.....	91	BWN012.....	43
BGG446P.....	108	BNL0150PN.....	63	BRB060P.....	91	BWN018.....	43
BGG450P.....	108	BNL0250BULK.....	63	BRB070P.....	89	BWN024.....	43
BGG452P.....	108	BNL0250P.....	63	BRB074P.....	89	BWN028.....	43
BGG454P.....	108	BNL0500BULK.....	63	BRB075P.....	89	BWN030.....	43
BGG456P.....	108	BNL0500P.....	63	BRB076P.....	89	BWN035.....	43
BGG458P.....	108	BNL1000BULK.....	63	BRB077P.....	89	BWN036.....	43
BGH022.....	32	BNL1000P.....	63	BRB256.....	92	BWN118.....	71
BGH024.....	32	BNL2000BULK.....	63	BRB264P.....	90	BWN124.....	71
BGH026.....	32	BNL2000P.....	63	BRB266P.....	90	BWN130.....	71
BGH028.....	32	BNP0030BULK.....	60	BRB274P.....	90	BWP0030BULK.....	65
BGH034.....	30	BNP0030PN.....	60	BRB276P.....	90	BWP0030PN.....	65
BGH036.....	30	BNP0060BULK.....	60	BRB284.....	90	BWP0060AP.....	66
BGH038.....	30	BNP0060PN.....	60	BRB290.....	90	BWP0060BULK.....	65
BGH040.....	30	BNP0100BULK.....	60	BRB402.....	89	BWP0060PGRAD.....	67
BGH068.....	31	BNP0100PN.....	60	BRB404.....	89	BWP0060PN.....	65
BGH070.....	31	BNP0125BULK.....	60	BRB406.....	89	BWP0150AP.....	66
BGK930P.....	62	BNP0125PN.....	60	BRB408.....	89	BWP0250AP.....	66
BGK936P.....	62	BNP0150BULK.....	60	BRC0005.....	59	BWP0250BULK.....	65
BGK940P.....	62	BNP0150PN.....	60	BRC0010.....	59	BWP0250P.....	65
BGS024.....	83	BNP0250BULK.....	60	BRC0500.....	59	BWP0250PGRAD.....	67
BGS040.....	83	BNP0250P.....	60	BRC1000.....	59	BWP0500AP.....	66
BGS042.....	83	BNP0500BULK.....	60	BRE000.....	57	BWP0500BULK.....	65













SH7/13	21	SSV103	253	SWN1016	241	SWN678	236
SH7/23/SC	22	SSV104	253	SWN160	90	SWN680	238
SH7/43	21	SSV106	253	SWN500	238	SWN682	238
SH7/53	21	SSV202	253	SWN501	238	SWN700	237
SH9/1L	24	SSV203	253	SWN502	238	SWN7010	237
SH9/250	24	SSV204	253	SWN503	238	SWN708	237
SH9/500	24	SSV304	254	SWN504	238	SWN710	237
SIB24	147	SSV504	254	SWN505	238	SWN712	237
SIB29	147	SSV802	254	SWN506	238	SWN714	237
SPP002	217	SSV804	254	SWN507	238	SWN7140	237
SPP004	217	ST1/2	242	SWN508	238	SWN715	237
SQ13UB	205	ST1/5	241	SWN509	238	SWN716	237
SQ18UB	205	ST1/6	241	SWN510	238	SWN718	236
SQ24UB	205	ST1/8	241	SWN511	238	SWN722	236
SQ28UB	205	ST11/5	242	SWN515	239	SWN730	243
SRB10UB	198	ST2/2/SC	244	SWN520	237	SWN732	243
SRB12UB	198	ST2/33C/SC	244	SWN522	237	SWN734	243
SRB14UB	198	ST2/44C/SC	244	SWN524	237	SWN736	243
SRB19UB	198	ST20/2	245	SWN525	237	SWN738	243
SRB24UB	198	ST20/3	245	SWN526	237	SWN750	242
SRB29UB	198	ST20/4	245	SWN528	237	SWN752	242
SRB34UB	198	ST3/2F	245	SWN532	238	SWN754	242
SRB40UB	198	ST4/2	245	SWN534	238	SWN756	242
SRB45UB	198	ST4/2F	245	SWN536	238	SWN761	244
SRB50UB	198	ST4R	245	SWN538	238	SWN762	244
SRB55UB	198	ST4W	245	SWN542	246	SWN765	244
SRB60UB	198	ST51/13	14, 228, 229, 271	SWN544	246	SWN766	244
SRB7UB	198	ST51/18	14	SWN546	246	SWN768	244
SRF380	246	ST52/13	14, 271	SWN548	246	SWN802	199
SRF384	246	ST52/18	14	SWN550	246	SWN804	199
SRF386	246	ST52/24	14	SWN552	246	SWN806	199
SRS001	226	ST53/13	14, 271	SWN5540	244	SWN808	199
SRS002	226	ST53/18	14	SWN5550	244	SWN810	199
SSD102	252	ST53/24	14	SWN556	243	SWN812	199
SSD102K	253	ST54/13	14, 271	SWN5560	243	SWN902	15
SSD103	252	ST54/18	14	SWN557	243	SWN908	15
SSD103K	253	ST54/24	14	SWN5570	243	SWN909	15
SSD104	252	ST54/28	14	SWN5580	243	SWN911	15
SSD104K	253	ST55/28	14	SWN559	243	SWN920	235
SSD106K	253	ST6/7	242	SWN5590	243	SWN925	235
SSD502	251	ST7/2	242	SWN560	243	SWN926	235
SST102	250	ST7/3	242	SWN5600	243	SWN927	235
SST1025K	252	ST7/3L	242	SWN564	241	SWN930	235
SST102K	252	SWL002	227	SWN566	241	SWN931	235
SST103	250	SWL006	227	SWN606	239	SWN933	235
SST103K	252	SWL008	227	SWN608	239	SWN934	235
SST104	250	SWL012	227	SWN610	239	SWN935	235
SST104K	252	SWL018	227	SWN652	236	SWN936	235
SST105K	252	SWL024	227	SWN654	236	SWN950	237
SST106	250	SWL028	227	SWN656	236	SWN952	237
SST106K	252	SWL030	227	SWN657	236	SWN954	237
SST108	250	SWL033	227	SWN658	236	SWN956	237
SST203	250	SWL036	227	SWN660	236	SWN961	199
SST203K	252	SWL040	227	SWN662	236	SWN962	199
SST3025	251	SWL140	227	SWN6620	236	SWN963	199
SST303K	252	SWM012	233	SWN664	236	SWN964	199
SST304	251	SWM016	233	SWN666	236	SWN965	199
SST304K	252	SWM018	233	SWN668	236	SWN966	199
SST502	251	SWM020	233	SWN670	236	SWN968	199
SST702	251	SWN1003	239	SWN672	236	SWN969	199
SST703	251	SWN1004	239	SWN674	236	SWNBOX3019	240
SST704	251	SWN1005	239	SWN676	236	SWNBOX3020	240
SST706	251	SWN1013	241	SWN677	238	SWP012	235



# How to order & customer support

## Ordering SciLabware products

All of the products in this catalogue are available through an extensive worldwide network of laboratory supply dealers. If you have difficulty locating a supplier please visit our website [www.scilabware.com](http://www.scilabware.com) or email our Customer Service team for assistance on [info@scilabware.com](mailto:info@scilabware.com).

## Product information

- All dimensions, capacities and weights are approximate unless otherwise stated. Please note that we reserve the right to alter the specifications of any product without prior notification. Similarly products may be discontinued and new products introduced without prior notice. For current information on products please visit [www.scilabware.com](http://www.scilabware.com).

## Technical support

- Additional product information and application guidance is available from SciLabware's glass and polymer technologists. For technical information regarding glass products please email: [glass@scilabware.com](mailto:glass@scilabware.com). For technical information regarding plastic products please email [azlon@scilabware.com](mailto:azlon@scilabware.com).

## Pack quantities

- The pack quantities shown in this catalogue are applicable to SciLabware's network of laboratory supply dealers. Whilst Dealers will prefer their customers to order in multiples of the pack quantity, to save repackaging costs, some Dealers are prepared to split packs for customers with modest requirements. Please contact your selected Dealer directly for advice.

## Enquiries for custom-made glassware

- SciLabware welcomes enquiries for glassware manufactured to your specific requirements. For details of this service and a free quotation please contact our Custom Glassware team by emailing [azlon@scilabware.com](mailto:azlon@scilabware.com).

## Enquiries for custom printed plastic bottles

- SciLabware welcomes enquiries for plastic bottles printed to your specific requirements. For details of this service and a free quotation please contact our Custom Printing team by emailing [azlon@scilabware.com](mailto:azlon@scilabware.com).

## Trademarks

- Quickfit<sup>®</sup>, MBL<sup>®</sup>, SVL<sup>®</sup>, Rotulex<sup>®</sup> and Lipsol<sup>®</sup> are registered trademarks of SciLabware Limited. Pyrex<sup>®</sup> and Rotaflo<sup>®</sup> are registered trademarks of Corning Inc. SciLabware is a registered user.

## © Copyright 2015

- All material in this catalogue is protected by copyright. Reproduction, publishing or storage of any text, photograph or illustration is prohibited unless authorised by SciLabware Limited.



# Terms and conditions

## 1. DEFINITIONS

In these conditions of Sale 'the Company' means Scilabware Limited 'the Buyer' means any company, firm, or individual from whom the Company receives an order which the Company has accepted in writing; 'the Goods' means the product, materials, equipment and/or services to be supplied by the Company; 'Specification' means the technical description (if any) of the Goods contained or referred to in the order.

## 2. APPLICABILITY OF CONDITIONS

The Company accepts orders for the supply of Goods subject only to these conditions. No variation of these conditions shall be valid or binding on the Company and these conditions shall override any inconsistent terms or conditions contained or referred to in any order, or correspondence of the Buyer or elsewhere unless such variation is made and accepted in writing by the Company.

## 3. PRICES

Unless fixed prices have been specifically agreed in writing by the Company notwithstanding any offer, quotation, tender price or price list, all prices are subject to alteration without notice and Goods will be invoiced at prices and, where applicable, exchange rates ruling at time of despatch. Unless otherwise agreed in writing all prices are strictly net of delivery charges, VAT and any other tax or duty which shall be added to the price payable by the Buyer.

## 4. TERMS OF PAYMENT

Accounts are payable strictly as specified on the Company's invoice. Usually this will be 30 days end of month, that is payment required the end of the month following invoice date. Credit terms may be offered subject to satisfactory credit vetting of the Buyer by the Company. The offer of credit will be at the sole discretion of the Company. Where credit is offered payment of the price and VAT and any other applicable costs shall be due. Where agreed credit limits have been exceeded, the company may request payment of current invoices before releasing further shipments.

Without prejudice to the Company's rights, such payment shall be a condition precedent to any further deliveries. The Company reserves the right to charge interest on late payment of 2% per month above the base rate quoted by HSBC from time to time from the due date until full payment is received.

Unless otherwise agreed in writing, the contract price shall be paid in Pound sterling. Where credit terms are not strictly adhered to the Company reserves the right to withdraw this facility at any time. In cases where credit is not offered payment may be required before release of goods by the Company.

The Company may request for overseas orders, payment by letter of credit established in favour of the Company at the time of placing of the order by the Buyer. This must be advised via a first class British Clearing Bank acceptable to the Company and maintained valid for cash drawings against presentation of the Company's invoice(s) until final contract payment but in any case for at least 3 months after scheduled completion of the contract taking into account any agreed extensions. The acceptance by the Company of the Buyer's order is conditional upon such letter of credit being received with the order. The Buyer agrees to arrange extension of such letter of credit for such period as may be requested by the Company from time to time.

Other payment terms may be requested from time to time, depending upon individual orders, customer risk or country risk and will be discussed and agreed between the Company and the Buyer before despatch.

No claim by the Buyer under warranty or otherwise shall entitle the Buyer to any deduction, retention or withholding of any part of any sums due for payment hereunder. The Buyer shall not be entitled to any set off or obligations within or between contracts with the Company. All consular and bank charges and import and customs duties and taxes arising from or by virtue of the contract must be paid by the Buyer.

## 5. TIME FOR DELIVERY

Dates quoted for delivery are estimated only and not conditions of sale. No claim shall be made by the Buyer nor shall the Buyer refuse to accept delivery on the grounds of any failure to deliver on any particular date or dates.

## 6. DELIVERY

Delivery shall be deemed to be effective when the Goods are unloaded at the delivery address nominated by the Buyer or his agent for delivery, save where the Goods are to be collected by the Buyer or his Agent, when the Goods are loaded onto the vehicle collecting them. The Company reserves the right to deliver goods by instalments and in such event each instalment shall be treated as a separate contract provided that deliveries of further instalments may be withheld until the Goods or materials comprised in earlier instalments have been paid for in full.

## 7. QUANTITY ORDERED AND DELIVERED

Goods can only be supplied in the 'standard pack or quantity' or 'minimum buying quantity' shown in the Company price lists or in multiples thereof. The Company will use all reasonable endeavours to produce and deliver the quantity of Goods ordered but every contract and delivery is subject to the margins of tolerances (whether over or under the quantity stipulated) customary in the trade and no guarantee or warranty is given or implied on the part of the Company which is incompatible with this provision.

## 8. CFR/CPT AND CIF/CIP TERMS

CFR and CIF prices where appropriate will be based on the current rates of freight and insurance. Should any fluctuations in freight and insurance rates occur before completion of a contract the Company reserves the right to amend such prices effective from the date of such changes in rates. CFR prices will include cost and freight by direct routes to principle ports, airports or railheads in a Buyer's territory relevant to the means of transport and at the Company's discretion. CIF prices will, in addition to CFR terms, include loss on the basis of CIF value plus 10% but not include insurance for breakage unless specifically requested. Any additional insurance will be for the Buyer's account. Cover notes will be issued for claims payable at destination and carrying an excess clause. It will be the Buyer's responsibility to present the claim in accordance with the provisions of these conditions.

## 9. PACKAGING

Prices shown in quotations or contracts will include the cost of the Company's normal packaging for destinations in the UK or for export unless stated otherwise. Any other forms of packaging supplied at customer's request will be charged extra and will be non-returnable.

## 10. NON-ACCEPTANCE OF DELIVERY

If the Buyer refuses or fails to take or accept delivery of the Goods at the time specified, the contract price shall nevertheless be paid as if delivery has taken place. The Company shall be entitled at its option to terminate the contract with immediate effect to dispose of the Goods as the Company may determine and to recover from the Buyer any loss and additional costs incurred as a result of such refusal or failure or to charge the Buyer for storage and other loss and expense reasonably incurred or suffered by the Company as a result of such refusal or failure but the Company shall not be bound to take any steps for the custody and care of such Goods or shall not be liable for any loss or damage suffered by the Buyer arising therefrom.

## 11. PASSING OF TITLE

(a) The absolute legal and beneficial ownership in all Goods shall remain vested in the Company and shall not pass to the Buyer until the purchase price of the order of which they form part (each order being considered as a whole) and all other monies owing by the Buyer to the Company on any account shall have been paid in full by the Buyer to the Company.

(b) Until such payment has been made, the Buyer shall hold the Goods sold as bailee of the Company and in a fiduciary capacity and shall not sell, dispose of, process or use the Goods except with the express

written permission of the Company and on condition that if authorised to resell the Goods to a third party, the Buyer shall not mingle any proceeds of sale with any other monies and shall at all times keep them in a separate bank account and identifiable as the Company's monies and shall forthwith account to the Company for the proceeds of sale to the extent of the Buyer's indebtedness to the Company.

(c) Pending receipt of payment made in accordance with these conditions the Goods shall be set aside and stored separately from other Goods in the possession of the Buyer so as to be clearly and separately identifiable and the Buyer shall deliver them upto the Company at any time on demand.

(d) In the event that the Buyer shall breach any of its obligations under these conditions or under any other agreement between the parties, the Company reserves the immediate right to repossess all or any of the Goods to which it has retained title aforesaid and thereafter to resell the same and for this purpose the Buyer hereby grants an irrevocable right of licence to the Company's servants and agents to enter upon all or any of its premises with or without vehicles during business hours. This right shall continue to subsist notwithstanding the termination of the contract for any reason and is without prejudice to any accrued rights of the Company hereunder or otherwise.

## 12. PASSING THE RISK

The risk in the Goods shall pass to the Buyer upon delivery. The Buyer shall insure the Goods with a reputable insurance company and if the same are damaged or destroyed, then such insurance monies as are payable shall be immediately paid by the Buyer to the Company to the extent of the indebtedness of the Buyer to the Company and without prejudice to any right of the Company to recover from the Buyer any balance of the purchase price remaining due under the contract.

## 13. CLAIMS

In the event of any loss or damage or delay to any Goods delivered at our risk to the Buyer or to his agent or otherwise to his order notice of the same shall be given to us in writing by the Buyer forthwith upon delivery (or, in the case of loss of any Goods, at the time when the Goods should have been delivered) and the Buyer shall at the same time take all necessary steps to notify the carrier in writing of any such loss damage or delay and where practicable shall enter a note of the same upon the carriers receipt. If by reason of the failure of the Buyer to give any such notice as provided above, the Company is precluded from making a recovery from the carrier in respect of the loss damage or delay complained of then the Company shall not be liable for any claim by the Buyer in respect thereof and the Buyer shall be liable to pay for the Goods as though no such loss damage or delay had occurred.

## 14. WARRANTY

The Company warrants that the Goods shall be in conformity with the Specification or be within its usual tolerances as to quality and finish. The Company shall replace or at its option refund the purchase price as applicable to any Goods which do not in its sole opinion comply with this warranty, provided always that any claim under this warranty is made within 24 hours of commencement of the processing of the Goods or (if earlier) within 28 days of delivery of the Goods alleged to be defective. It is the Buyer's responsibility to determine whether the Goods are suitable for the contemplated use, whether or not such use is known to the Company. No warranty, condition or representation is given or made as to the quality of the Goods supplied hereunder their condition or their fitness for any particular purpose and any such warranty, condition or representation whether express or implied whether by statute, by collateral agreement or otherwise is hereby excluded.

## 15. RETURNS POLICY

Under normal trading circumstances, the Company does not accept the return of any products that meet the product warranty criteria outlined in section 14.

## 16. LIMITATION OF LIABILITY

Except for death or personal injury caused by the negligence of the Company, the Company's aggregate liability to the Buyer howsoever arising whether for negligence, breach of contract, misrepresentation or otherwise shall under no circumstances exceed the cost of the defective, damaged or undelivered Goods which give rise to such liability as determined by the net price invoiced to the Buyer in respect of any occurrence or series of occurrences.

## 17. CANCELLATION BY THE BUYER

The Buyer may cancel or suspend the contract only with the Company's prior written consent following agreement by the Buyer to reimburse the Company in an amount to be determined by the Company or the Buyer may, not later than 3 days before the scheduled delivery date, by written notice, cancel the order for Goods provided that the Buyer shall reimburse the Company for any costs incurred up to the date of receipt of the notice of such cancellation.

## 18. TERMINATION BY THE COMPANY

The Company shall (without prejudice to any of its other rights hereunder) be entitled to terminate any contract forthwith by written notice to the Buyer if the Buyer shall:

- Become insolvent
- Fail to pay any amounts falling due (whether under these conditions or otherwise) to the Company within 30 days of the date payment is due.
- Have a Receiver appointed
- Pass a resolution for winding-up (other than for purposes of reconstruction or amalgamation)
- Commit a breach of any term of the contract or any other contract with the Company.

## 19. FORCE MAJEURE

If the commencement, continuation or complete performance by the Company of its obligations under this contract is prevented, hindered, delayed or rendered uneconomic by reason of force majeure then the Company shall not be responsible to the Buyer for any loss or damage incurred or sustained by the Buyer as a result. For the purpose of this condition, the term Force Majeure shall include any factor affecting the performance of this contract attributable to acts, events, non-happenings, omissions or incidents beyond the reasonable control of the Company and, in particular, (but without limiting the generality of the foregoing), the following, namely: strikes, lock-outs, riots, civil revolution, war, state of national emergency of governmental action, trade dispute or labour disturbance, accident, break down of plant or machinery, difficulty or increased expense in obtaining workmen, materials or transport, fire, explosion, storm, flood, earthquake or other natural physical disaster or circumstances affecting the supply of the Goods (or the raw materials therefore) by a Company's normal source of supply or the delivery of the Goods by the Company's normal route or means of delivery.

## 20. IMPORT LICENCES

The Buyer's order must specify the number, date of expiry and value of any necessary Import Licence.

## 21. NOTICES

Any notice hereunder shall be deemed to have been given if sent by pre-paid, first class post, fax or email to the party concerned at its last known address. Notices sent by first-class post shall be deemed to have been given 7 days after dispatch and notices sent by fax or email shall be deemed to have been given on the date of dispatch.

## 22. CONSTRUCTION

All contracts made with the Company shall be governed by and construed according to the laws of England and the parties hereby submit to the jurisdiction of the English courts.

April 2015

# PYREX<sup>®</sup>

# 100

1915 - 2015



## Authorised distributor

### In Australia:

For customer service, call 1300-735-292  
To email an order, [ordersau@thermofisher.com](mailto:ordersau@thermofisher.com)  
To order online: [thermofisher.com](http://thermofisher.com)

### In New Zealand:

For customer service, call 0800-933-966  
To email an order, [ordersnz@thermofisher.com](mailto:ordersnz@thermofisher.com)  
To order online: [thermofisher.com](http://thermofisher.com)

**ThermoFisher**  
SCIENTIFIC