



SENSING TECHNOLOGIES

An Amphenol Company

SHORT-FORM
PRODUCT
CATALOG

VIBRATION
MONITORING
SOLUTIONS



wilcoxon.com
buy.wilcoxon.com

CONTENTS

Applications.....	6
Sensors.....	10
High performance.....	11
General purpose.....	12
Extended temperature range.....	13
High sensitivity, low frequency.....	14
Integral cable.....	15
High g sensors.....	16
Seismic.....	17
Dual vibration + temperature output.....	18
Velocity sensors.....	19
Specialty.....	20
Traditional & triaxial.....	21
Hazardous area sensors.....	22
Cables & connectors.....	24
Cable & connector design.....	25
Cable ordering guide.....	26
Standard cable assemblies.....	27
Connectors.....	28
Cables.....	29
Cable considerations.....	30
Mounting accessories.....	31
Studs and cementing pads.....	32
Magnetic mounts.....	33
Enclosures.....	34
VibraLINK® (VL) series.....	35
Junction boxes.....	37
Instrumentation.....	38
MAC800 handheld vibration meters.....	38
REF2510R portable reference source.....	41
Portable power supplies.....	42
Machinery fault reference guide.....	43
Complete process solutions.....	44
Monitoring options for process control systems.....	45
4-20 mA sensors.....	46
Monitored machinery in process applications.....	47
Hazardous area 4-20 mA sensors.....	48
Digital sensors with HART® protocol.....	49
Process control Display meters.....	50
Intelligent transmitters – 4-20 mA.....	52
Transmitters & alarms.....	53
Sensor selection chart.....	56
Service & support.....	58
Resources.....	59



An Amphenol Company

EVERYTHING YOU NEED FROM ONE SOURCE

There's no better place to start than Wilcoxon!

Wilcoxon Sensing Technologies solutions are at work providing excellent performance, long-term reliability, and superior value to many customers in a wide variety of applications around the world. Thank you for your interest in our vibration monitoring solutions. This catalog features a full range of cost-effective products and a variety of beneficial tips and helpful insight.

Saving you time and simplifying your search for high quality, long-lasting vibration monitoring products is important to us. We look forward to being your supplier of choice for vibration monitoring products, including:

- » Sensors
- » Portable instrumentation
- » iT transmitters
- » Cable assemblies
- » Enclosures
- » Mounting hardware & accessories



LEGACY OF SUCCESS

Wilcoxon Sensing Technologies has a strong history of providing market-leading products for demanding industrial, marine, and defense applications. Since 1960, Wilcoxon has been and continues to be a world-leading manufacturer and supplier of high-quality vibration monitoring products known for their reliability, long life, and excellent value. As an ISO 9001:2015 certified company, we are committed to setting the industry standard for quality of design, manufacture, assembly, and distribution of vibration sensors, underwater acoustic sensors, and related equipment.

In 2017, the Wilcoxon brand was purchased by the Amphenol Corporation, one of the largest manufacturers of interconnect products in the world. Wilcoxon has been integrated into the Amphenol Sensor Technology Group. In 2018, Wilcoxon moved to a new, larger factory and office building in Frederick, Maryland to support our continued growth, allowing us to meet the needs of the many markets and industries we serve around the world.

Today, we continue to be at the forefront of technological development. We are excited for the future, and the competitive advantages that our technology, defined by Wilcoxon quality and reliability, brings to our customers.

HOW IT WORKS

The tools you need for vibration monitoring starts here →

1



SENSORS are mounted to rotating equipment at each bearing housing to measure the machine's vibration levels. The sensor translates vibration to an electrical signal sent to a measurement device.

COMPLETE VIBRATION MONITORING SOLUTION

2



MOUNTING HARDWARE – a range of studs, cementing pads, and magnet mounts – is needed to permanently or temporarily attach the sensor to the machine.

3



CABLE ASSEMBLIES carry the signal from the sensor. Choose a suitable cable for the environment, with the appropriate connectors for the sensor and termination ends.

4



ENCLOSURES create a central data collection point for up to 48 sensors, improve safety, and simplify access to critical machine information.

5



INSTRUMENTATION including handheld data collectors and reference sources are useful tools for all analysts, in both permanent and portable installations.

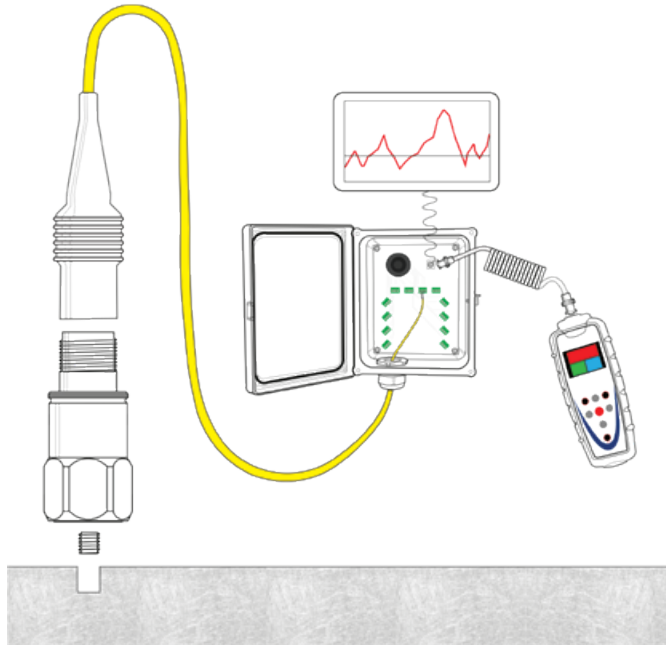

COMPLETE VIBRATION MONITORING SOLUTIONS

A machine's vibration levels indicate its condition. Developing faults appear as changes in vibration, often before other signs are noticeable, and specific machine problems show particular patterns of changing vibration levels, making fault identification easier and more accurate. If you know which machines need maintenance, what the problems are, and how soon to address them, your predictive or preventative maintenance program is more effective and operations are more efficient.

How to incorporate vibration data into your monitoring setup will depend on your program's needs, but there are two basic approaches: permanent installations or walkaround monitoring.

Permanent installation

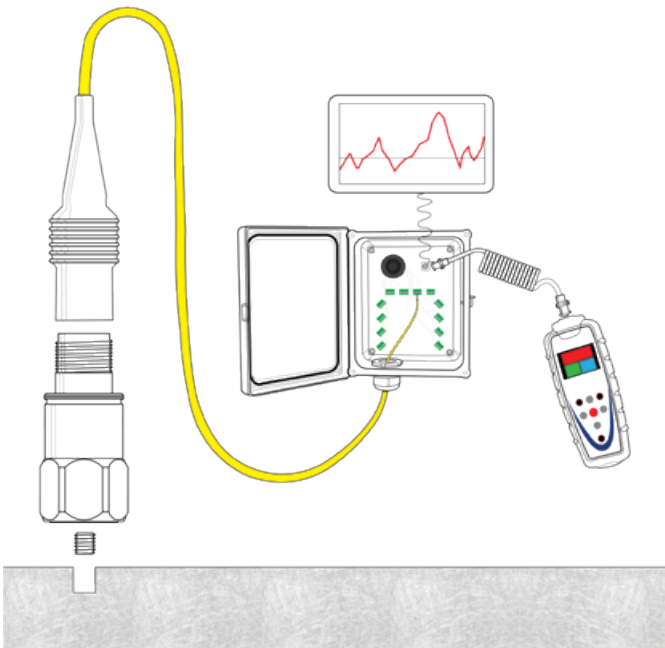

A permanent installation provides reliable data and simplifies access to machine information.

Benefits include:

- » remote access from the measurement point
- » access to multiple readings in central location
- » reduces measurement time
- » full frequency range of the sensor is available
- » improved safety
- » continuous monitoring of changing vibration

Some drawbacks:

- » higher cost for dedicated sensors, cabling, and mounting hardware
- » lacks flexibility to check different measurement points

Walkaround monitoring

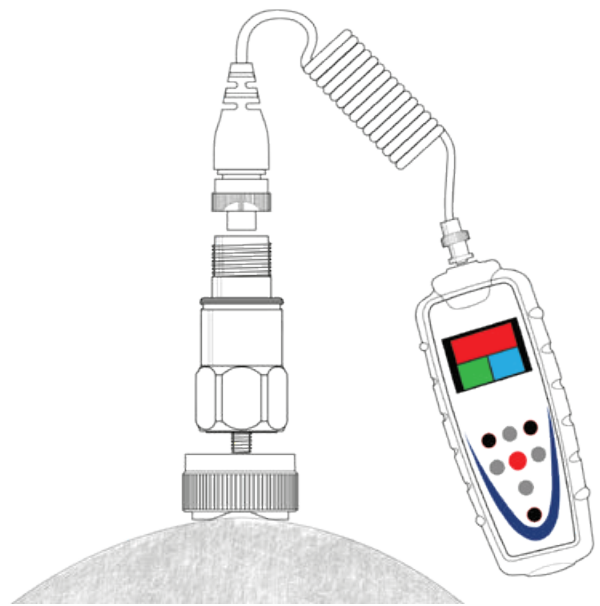

Walkaround routes allow flexibility and are often used with fewer measurement points.

Benefits include:

- » lower cost alternative to installing dedicated sensors at each measurement point
- » offers flexibility in checking different measurement points
- » useful for establishing baselines prior to permanently mounting sensors

Some drawbacks:

- » poor repeatability of readings
- » limitation in frequency range
- » safety risks to personnel from moving parts or unsafe conditions

APPLICATIONS

PULP & PAPER



With the high number of rotating machines found in pulp and paper manufacturing facilities, there's a huge potential benefit to vibration monitoring. High temperature accelerometers with reliable performance up to 150°C are ideal for use on rotating components in dryer sections, and rugged IP68 rated connectors and cables have the chemical and heat resistance needed throughout the plant.

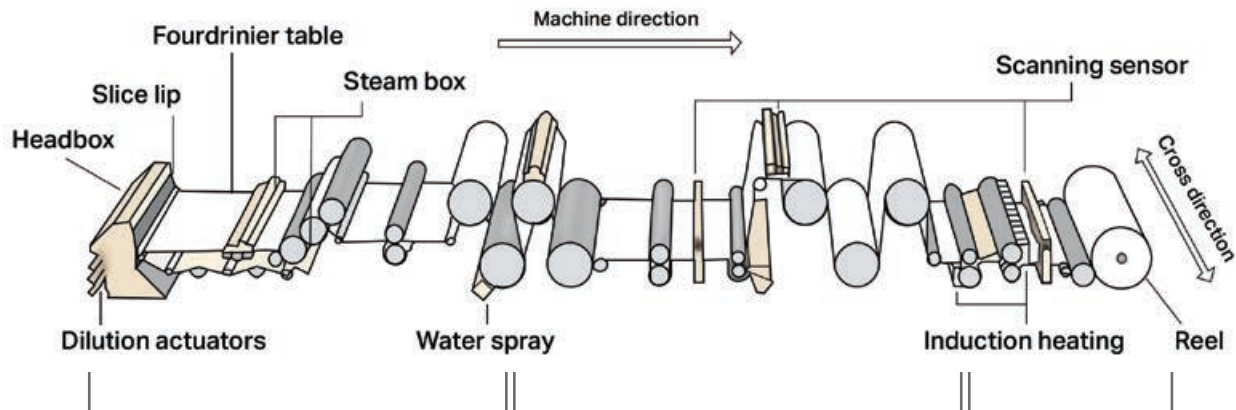

Forming/press sections	Dryer section	Calendering section
Caustic chemicals, high moisture	High temperatures, sudden temperature spikes, high moisture	High moisture, high pressure
786A standard accelerometer 786LF low frequency accelerometer 6Q splash-proof connectors J9T2A Teflon cables	HT series high temperature accelerometers 6Q splash-proof connectors J9T2A Teflon cables	786A accelerometer 6Q/6W connectors J9T2A/J9F Teflon cables

OIL REFINERIES



With the variety of hazardous locations found throughout refineries and the high cost of unscheduled downtime, vibration sensors with Class I certifications are a good investment. Wilcoxon offers intrinsically safe sensors for dynamic data and explosion-proof sensors for 24/7 trend data to fulfill the complex requirements of refineries.



Class I, Div 1 (Zone 0/1)	Explosion-proof	Class I, Div 2 (Zone 2)
786A-IS, 787A-IS intrinsically safe accelerometers PC420-IS certified 4-20 mA sensors IS safety barrier strips	PC420VP-EX explosion-proof 4-20 mA sensors	4-20 mA sensors 786A-D2, 786-500-D2, 787A-D2 certified accelerometers R6D2-0-J9T2A cable assemblies

CONDITION-BASED MONITORING

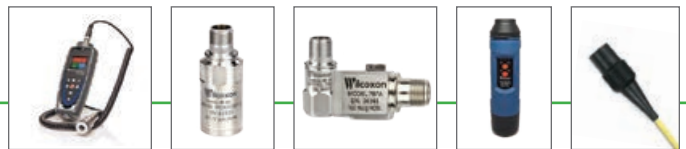

Vibration monitoring plays an essential role in an effective predictive maintenance program. Plants with pumps, motors, fans, or any rotating machines that are critical to operations can benefit from vibration data indicating changes in machine condition or early fault detection. Sensing solutions are available for every application.

786A, 787A	Accelerometers for general machine monitoring on motors, fans, pumps, and gear mesh
R6W-J10	IP67 cable assemblies for permanent installations and flexible cable routing
MAC800 / REF2510R	Handheld meters and vibration reference sources for walkaround monitoring programs
PC420 series	4-20 mA sensors for process applications
Mounting hardware	Studs, adhesives, cementing pads, isolators, and accessories for permanent or temporary installations
VL enclosures	Switchboxes provide a central data collection point to avoid lengthy data-collection routes

WIND TURBINES

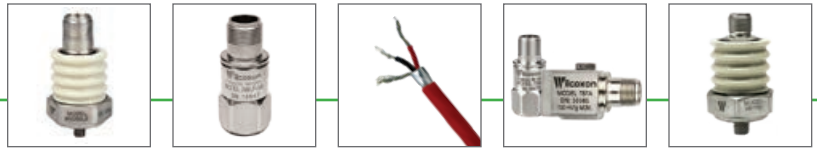

Monitoring programs for wind turbines face unique technical challenges, with important slow turning machinery and the potential for high electromagnetic interference. Generators should be monitored with highly isolated sensors and foil shielded cable for improved EMI resistance, while the turbine’s main bearing can be monitored with high sensitivity, low frequency sensors. Gear mesh faults are detectable with general purpose accelerometers.

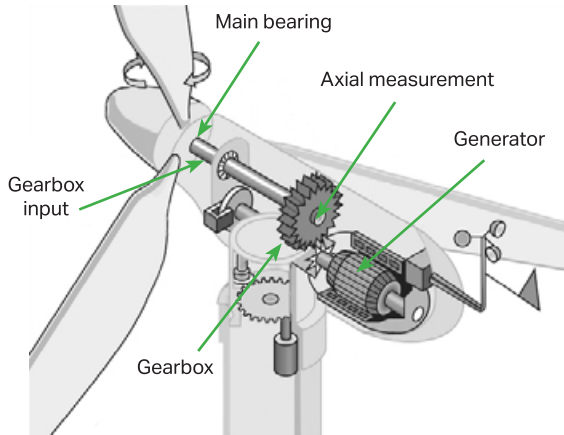

Generators	High voltage sensors: HV100/HV200 HV100LF/HV200LF J9F foil shielded cable assemblies
Main bearing	Low frequency sensors: 786LF-500, 787-500 HV100LF-500, HV201LF-500
Gearbox	General purpose accelerometers: 780A, 786A, 787A

CHEMICAL PROCESSING

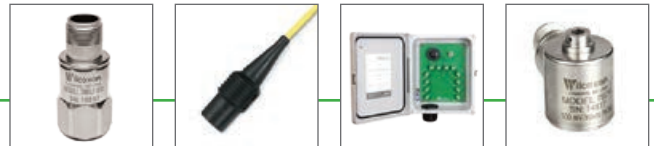

Chemical processing facilities rely on cooling towers to recycle water and help complete their processes. Vibration measurements on fans, motors, and gearboxes can help identify problems such as misalignment and imbalance before failure causes unexpected downtime.

786LF-500, 797L	Low frequency accelerometers for measurements on slow-turning fan shaft
R6Q-J9T2A, 786F	IP68 rated cable/connector assemblies with high chemical resistance, integral cable sensors
VL enclosures	Switchboxes to provide a central data collection point and shorten active collection time

NUCLEAR POWER



Sensors, cable assemblies, and mounting accessories with radiation resistance up to 10^7 RADs make vibration monitoring possible on critical machines in nuclear power plants.

793R, 797R	Radiation resistant accelerometers for gearboxes and high frequency analysis
793VR	Radiation resistant velocity sensors for general machinery analysis
R6QN(I) connectors, J9T2(S) cables	Neoprene connectors and Tefzel cable (optional stainless steel braid) for chemical resistance and material approvals

SEISMIC & STRUCTURAL MONITORING



Extremely low frequency applications, such as construction zones for tunnels and bridges, earthquake detection and engineering, and structural health monitoring use seismic sensors to detect changes that affect critical infrastructure or indicate seismic activity.

731A/P31	Accelerometer/power amplifier system with 10 V/g sensitivity
731-207	Compact seismic sensor
J9T2A / J9F cable	Low noise, shielded, Teflon jacketed cable to protect the signal from electrical interference
799M	Accelerometer with 1 V/g output for high sensitivity and intermediate frequency response

CEMENT MANUFACTURING



Vibration monitoring is useful at several stages of the cement manufacturing process. Critical fans, motors, and conveyors can be monitored for signs of developing faults with sensing solutions that work in environments with dust, debris, and high temperatures.

PC420V series, 786A, 787A	4-20 mA velocity sensors, standard accelerometers to detect machine imbalance
787A, R6Q-J9T2A	Side exit, hermetically sealed sensors and IP68 rated cable assemblies for contamination protection
HT series, R6Q-J9T2A	High temperature accelerometers and cable assemblies for kiln areas
786A, 787A	Accelerometers to detect belt drive misalignment using dynamic analysis of vibration data
iT300, iT301	Transmitters for field-configurability and connection to plant infrastructure, enabling dynamic analysis

MINING

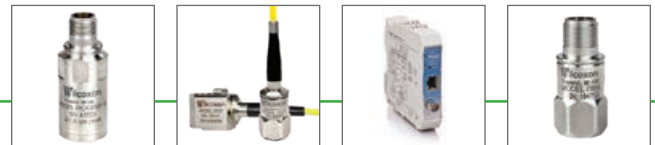

Maximizing operational uptime and efficiency is paramount in mining operations. Establishing baseline vibration levels and continuously trending data from key components helps to detect machine faults early, helping you reduce overall maintenance costs and keep working.

PC420 series, 786A, 787A	Sensors with broad frequency response for detecting gear mesh faults, monitoring geared motors and belts in conveyor drive system, and continuous monitoring of machines running 24/7
R6Q-J9T2A, 786F	IP68 rated cabling and watertight sensors to detect pump corrosion
786A, 786A-I + iT300	High frequency sensors, transmitters for field-configurability and connection to plant infrastructure to detect bearing damage or fatigue

SENSORS

Since its founding in 1960, Wilcoxon has been the industry leader in innovative sensor technology and reliable, high-quality products. Our sensors are in use around the world in a variety of facilities, enabling reliable data acquisition and valuable information on machine condition.

5 things to consider for sensor selection

1 Overall vibration level

The vibration level on most machines is unlikely to be high enough to cause sensor overload or require a specialty sensor, but certain faults can produce high vibrations. When choosing a sensor, consider which faults are most likely to develop and which are of interest for the machine along with baseline machine vibration.

2 Frequency range of interest

Depending on the size and type of machine, the location where the sensor will be mounted, and the number of components (among other factors), the frequency range being measured can vary. A sensor should be able to capture the appropriate frequencies and output reliable data.

3 Acceleration vs. velocity

Accelerometers should be used in most applications on most machinery. Piezovelocity sensors are well-suited for monitoring mid-frequency vibrations on common rotating machines; at very high or low frequencies (above 10 kHz or below 1 Hz), specialty accelerometers are a better choice.

4 Temperature range

If operating temperatures won't exceed 120°C (248°F), most standard accelerometers are a good choice; above that, choose an HT series sensor, which performs well up to 150°C. Sensor response varies more at high temperatures, which can affect measurement accuracy and should be factored into your analysis.

5 Environmental considerations

Make sure to measure the ambient temperature, humidity, and moisture levels, determine whether any contaminants such as dust, liquids, debris or corrosive chemicals are present, and check for nearby sources of interference (unusually high EMI, RFI, or ESD). Sensors to be used in hazardous areas should have the correct certification requirements.

HIGH PERFORMANCE

Our customer favorite high-performance accelerometers have high MTBF for long-term reliability and tighter sensitivity tolerance for more precise measurements.



Wilcoxon model	• 786A	• 787A	786LF	• 780A
Sensitivity	100 mV/g	100 mV/g	100 mV/g	100 mV/g
Sensitivity tolerance	±5%	±5%	±5%	±5%
Frequency response ±3 dB, Hz	0.5 - 14,000	0.5 - 10,000	0.1 - 13,000	0.5 - 14,000
Resonance frequency	30 kHz	22 kHz	30 kHz	30 kHz
Electrical noise 100 Hz	5 µg/√Hz	5 µg/√Hz	3 µg/√Hz	5 µg/√Hz
Max temperature	120°C	120°C	120°C	120°C
Bias output voltage	12 VDC	12 VDC	13 VDC	12 VDC
Grounding	case isolated	case isolated	case isolated	case isolated
Mounting	1/4-28 tapped hole	1/4-28 captive screw	1/4-28 tapped hole	1/4-28 tapped hole
Output connector	2-pin MIL-C-5015 or 4-pin M12	2-pin MIL-C-5015 or 4-pin M12	2-pin MIL-C-5015	2-pin MIL-C-5015
Compliance	CE, API 670 • [CSA/ATEX/IECEX]	CE, API 670 • [CSA/ATEX/IECEX]	CE	CE, API 760 • [CSA/ATEX/IECEX]

**LIFETIME
WARRANTY**

**LIFETIME
WARRANTY**

**LIFETIME
WARRANTY**

**LIFETIME
WARRANTY**

- Hazardous area certified models available for the 786A, 787A and 780A. See [page 23](#) for certification details.

GENERAL PURPOSE

Accelerometers with a broad frequency range suited for general monitoring of rotating machinery. These sensors are used to detect faults between 30-60,000 CPM and track overall vibration levels.



Wilcoxon model	786B-10	787B	780B	785A
Sensitivity	100 mV/g	100 mV/g	100 mV/g	100 mV/g
Sensitivity tolerance	±10%	±10%	±10%	±10%
Frequency response ±3 dB, Hz	0.5 - 14,000	0.5 - 10,000	0.5 - 14,000	1.0 - 12,000
Resonance frequency	30 kHz	22 kHz	30 kHz	30 kHz
Electrical noise 100 Hz	5 µg/√Hz	5 µg/√Hz	5 µg/√Hz	6 µg/√Hz
Max temperature	120°C	120°C	120°C	120°C
Bias output voltage	12 VDC	12 VDC	12 VDC	12 VDC
Grounding	case isolated	case isolated	case isolated	case isolated
Mounting	1/4-28 tapped hole	1/4-28 captive screw or M8 captive screw	1/4-28 tapped hole	1/4-28 captive screw
Output connector	2-pin MIL-C-5015 or 4-pin M12	2-pin MIL-C-5015 or 4-pin M12	2-pin MIL-C-5015	2-pin MIL-C-5015
Compliance	CE	CE	CE	CE

**LIFETIME
WARRANTY**

**LIFETIME
WARRANTY**

**LIFETIME
WARRANTY**

**LIFETIME
WARRANTY**

EXTENDED TEMPERATURE RANGE

The HT series provides superior long-lasting performance in 150°C environments, with components designed to withstand continuous high operating temperatures. For more extreme temperatures, the 376 can be used up to 260°C with the CC701HT external charge amplifier.



Wilcoxon model	HT780A	HT786A	HT787A	376/CC701HT
Sensitivity	100 mV/g	100 mV/g	100 mV/g	100 mV/g
Sensitivity tolerance	±5%	±5%	±5%	±10%
Frequency response ±3 dB, Hz	0.5 - 14,000	0.5 - 14,000	0.5 - 10,000	1.0 - 15,000
Resonance frequency	30 kHz	30 kHz	22 kHz	30 kHz
Electrical noise 100 Hz	5 µg/√Hz	5 µg/√Hz	5 µg/√Hz	1 µg/√Hz
Max temperature	150°C	150°C	150°C	376: 260°C CC701HT: 100°C
Bias output voltage	at 25°C: 13 VDC at 150°C: 12 VDC	at 25°C: 13 VDC at 150°C: 12 VDC	at 25°C: 13 VDC at 150°C: 12 VDC	12 VDC
Grounding	case isolated	case isolated	case isolated	case isolated
Mounting	1/4-28 tapped hole	1/4-28 tapped hole	1/4-28 captive screw	1/4-28 tapped hole
Output connector	2-pin MIL-C-5015	2-pin MIL-C-5015	2-pin MIL-C-5015	376: microdot CC701HT: BNC
Compliance	CE	CE	CE	CE

**LIFETIME
WARRANTY**

**LIFETIME
WARRANTY**

**LIFETIME
WARRANTY**

HIGH SENSITIVITY, LOW FREQUENCY

With an extended low-end frequency response, Wilcoxon's high sensitivity, low frequency sensors detect both high- and low-speed vibrations, making them ideal for critical slow-turning machinery.



Wilcoxon model	• 786-500	• 787-500	786LF-500	799LF
Sensitivity	500 mV/g	500 mV/g	500 mV/g	500 mV/g
Sensitivity tolerance	±5%	±5%	±5%	±5%
Frequency response ± 3 dB, Hz	0.2 - 14,000	0.2 - 10,000	0.1 - 13,000	0.1 - 2,500
Resonance frequency	30 kHz	22 kHz	30 kHz	18 kHz
Electrical noise 100 Hz	1.5 µg/√Hz	1.5 µg/√Hz	2 µg/√Hz	1 µg/√Hz
Max temperature	120°C	120°C	120°C	120°C
Bias output voltage	12 VDC	12 VDC	13 VDC	8 VDC
Grounding	case isolated	case isolated	case isolated	case isolated
Mounting	1/4-28 tapped hole	1/4-28 captive screw	1/4-28 tapped hole	1/4-28 tapped hole
Output connector	2-pin MIL-C-5015 or 4-pin M12	2-pin MIL-C-5015 or 4-pin M12	2-pin MIL-C-5015	2-pin MIL-C-5015 or 4-pin M12
Compliance	CE • [CSA/ATEX/IECEX]	CE • [CSA/ATEX/IECEX]	CE	CE

**LIFETIME
WARRANTY**

**LIFETIME
WARRANTY**

**LIFETIME
WARRANTY**

**LIFETIME
WARRANTY**

- Hazardous area certified models available for the 786-500 and 787-500. See [page 23](#) for certification details.

INTEGRAL CABLE

Wilcoxon's IP68 rated integral cable sensors help to prevent contamination by dust or debris and can be used with confidence in submerged applications of 30 feet or more.



Wilcoxon model	• 786F	787F	712F	780FM-2-J88C
Sensitivity	100 mV/g	100 mV/g	100 mV/g	100 mV/g
Sensitivity tolerance	±5%	±5%	±10%	±15%
Frequency response ± 3 dB, Hz	0.5 - 13,000	0.5 - 10,000	3.0 - 25,000	0.4 - 12,000
Resonance frequency	30 kHz	22 kHz	>45 kHz	30 kHz
Electrical noise 100 Hz	5 µg/√Hz	5 µg/√Hz	10 µg/√Hz	4 µg/√Hz
Max temperature	120°C	120°C	120°C	Sensor: 120°C Cable: 80°C
Bias output voltage	12 VDC	12 VDC	12 VDC	12 VDC
Grounding	case isolated	case isolated	case isolated	case isolated
Mounting	1/4-28 tapped hole	1/4-28 captive screw	8-32 captive screw or M4 captive screw	1/4-28 tapped hole, 2-pole magnet
Output connector	integral cable, blunt cut	integral cable, blunt cut	integral cable, blunt cut	integral cable, BNC
Compliance	CE • [CSA/ATEX/IECEX]	CE	CE	CE



- Hazardous area certified models available for the 786F. See [page 23](#) for certification details.

HIGH G SENSORS

Accelerometers with a 500 g or greater range for high-impact applications, such as compressors, spindles, fans, gearboxes, or where there are high-speed components with higher harmonics.



Wilcoxon model	786A-I	997	• 793-10	732A
Amplitude range	500 g	600 g	500 g	500 g
Sensitivity	10 mV/g	10 mV/g	10 mV/g	10 mV/g
Sensitivity tolerance	±5%	±10%	±5%	±5%
Frequency response ± 3 dB, Hz	0.5 - 14,000	0.5 - 29,000	1.0 - 15,000	0.5 - 25,000
Resonance frequency	30 kHz	>45 kHz	25 kHz	60 kHz
Electrical noise 100 Hz	23 µg/√Hz	9 µg/√Hz	40 µg/√Hz	3 µg/√Hz
Max temperature	120°C	120°C	120°C	120°C
Bias output voltage	12 VDC	12 VDC	12 VDC	10 VDC
Grounding	case isolated	case isolated	case isolated	case grounded
Mounting	1/4-28 tapped hole	8-32 captive screw or M4 captive screw	1/4-28 tapped hole	10-32 tapped hole
Output connector	2-pin MIL-C-5015	integral cable, blunt cut	2-pin MIL-C-5015	10-32 coaxial
Compliance	CE	CE	CE • [ATEX]	CE

- Hazardous area certified model available for the 793-10. See [page 23](#) for certification details.

SEISMIC

Our seismic sensors are recognized as setting the standard for ultra-low frequency monitoring. They are used in applications ranging from earthquake detection systems and structural monitoring to construction zone observation and isolation tables.



Wilcoxon model	731A/P31	735T	731-207	799M
Sensitivity	10 V/g	10 V/g	10 V/g	1 V/g
Sensitivity tolerance	±10%	±10%	±10%	±5%
Frequency response ± 3 dB, Hz	0.05 - 450	0.01 - 350	0.2 - 1,300	0.2 - 2,500
Resonance frequency	750 Hz	700 Hz	2.4 kHz	18 kHz
Electrical noise 100 Hz	0.004 µg/√Hz	3.5 ng/√Hz	0.03 µg/√Hz	1 µg/√Hz
Max temperature	65°C	65°C	70°C	80°C
Bias output voltage	9 VDC	8 VDC	10 VDC	8 VDC
Grounding	case isolated	case isolated	case grounded	case isolated
Mounting	3/8-16 tapped hole	M6x1 tapped hole	10-32 tapped hole	1/4-28 tapped hole
Output connector	2-pin MIL-C-5015	4-pin M12	10-32 coaxial	2-pin MIL-C-5015
Compliance	CE	CE	CE	CE

**LIFETIME
WARRANTY**

DUAL VIBRATION + TEMPERATURE OUTPUT

Dual-output sensors provide both vibration and temperature measurements for more data all in one, simplifying your monitoring setup.



Wilcoxon model	• 786T	787T	793T-3	797T-1
Sensitivity	100 mV/g	100 mV/g	100 mV/g	100 mV/g
Sensitivity tolerance	±5%	±5%	±5%	±5%
Frequency response ± 3 dB, Hz	0.5 - 12,000	0.5 - 12,000	0.5 - 15,000	1.0 - 12,000
Resonance frequency	30 kHz	22 kHz	24 kHz	26 kHz
Electrical noise 100 Hz	5 µg/√Hz	5 µg/√Hz	5 µg/√Hz	1 µg/√Hz
Max temperature	120°C	120°C	120°C	120°C
Temperature sensor output sensitivity	10 mV/°C	10 mV/°C	10 mV/K	10 mV/K
Bias output voltage	12 VDC	12 VDC	12 VDC	12 VDC
Grounding	case isolated	case isolated	case isolated	case isolated
Mounting	1/4-28 tapped hole	1/4-28 captive screw	1/4-28 tapped hole	1/4-28 captive screw
Output connector	3-pin MIL-C-5015	3-pin MIL-C-5015	3-pin MIL-C-5015	3-pin MIL-C-5015
Compliance	CE • [CSA/ATEX/IECEX]	CE	CE	CE



- Hazardous area certified models available for the 786T. See [page 23](#) for certification details.

VELOCITY SENSORS

Piezoelectric velocity sensors offer the convenience and performance of a direct velocity output without the drawbacks of moving-coil or other styles of velocity sensors.



Wilcoxon model	 • 793V	793V-5	• 797V	893V
Sensitivity	100 mV/in/sec	500 mV/in/sec	100 mV/in/sec	100 mV/in/sec
Sensitivity tolerance	±10%*	±10%	±10%	±5%
Frequency response ± 3 dB, Hz	2.5 - 7,000	5.0 - 7,000	1.6 - 7,000	4.5 - 5,000
Resonance frequency	15 kHz	15 kHz	18 kHz	15 kHz
Electrical noise 100 Hz	1.0 µin/sec/√Hz	0.4 µin/sec/√Hz	0.8 µin/sec/√Hz	1.5 µin/sec/√Hz
Max temperature	120°C	120°C	120°C	120°C
Bias output voltage	10 VDC	10 VDC	10 VDC	12 VDC
Grounding	case isolated	case isolated	case isolated	case isolated
Mounting	1/4-28 tapped hole	1/4-28 tapped hole	1/4-28 captive screw	1/4-28 tapped hole
Output connector	2-pin MIL-C-5015	2-pin MIL-C-5015	2-pin MIL-C-5015	2-pin MIL-C-5015
Compliance	CE • [FM/CSA/ATEX]	CE	CE • [FM]	CE

**LIFETIME
WARRANTY**

**LIFETIME
WARRANTY**

**LIFETIME
WARRANTY**

• Hazardous area certified models available for the 793V and 797V. See [page 23](#) for certification details.

 Radiation-resistant model available for the 793V (see [Radiation-resistant products on page 22](#)).

* Model 793V100-5: 100 mV/ips sensor with a ±5% sensitivity tolerance.

SPECIALTY

Designed for a variety of specialized applications. HV series sensors provide over 6,000 volts of isolation between the connector and base, and high EMI resistance for areas such as wind turbines. The 746 is an underwater accelerometer with a 650 psi pressure rating. The LPA100T operates with < 300 μ W, making it ideal for wireless, battery-operated or energy harvesting applications, and offers a Class I, Div 2 certified option.



Wilcoxon model	HV100/200	HV100LF/200LF	746	• LPA100T
Sensitivity	100 mV/g	100 mV/g*	100 mV/g	50 mV/g
Sensitivity tolerance	±5%	±5%	±5%	±5%
Frequency response ± 3 dB, Hz	0.5 - 12,000	0.1 - 11,000	1.0 - 15,000	0.3 - 15,000
Resonance frequency	25 kHz	28 kHz	30 kHz	30 kHz
Electrical noise 100 Hz	5 μ g/ \sqrt Hz	5 μ g/ \sqrt Hz	0.8 μ g/ \sqrt Hz	16 μ g/ \sqrt Hz
Max temperature	120°C	120°C	80°C	120°C
Bias output voltage	12 VDC	13 VDC	10 VDC	1.5 VDC ±5%
Grounding	case isolated	case isolated	case isolated	case isolated
Mounting	1/4-28, M8 or M6 integral stud	1/4-28, M8 or M6 integral stud	10-32 tapped hole	1/4-28 tapped hole
Output connector	HV100: 4-pin M12 HV200: 2-pin MIL-C-5015	HV100LF: 4-pin M12 HV200LF: 2-pin MIL-C-5015	integral cable, blunt cut	4-pin M12
Compliance	CE	CE	CE	CE • [CSA/ATEX]

• Hazardous area certified model available for the LPA100T. See [page 23](#) for certification details.

* HV100LF/200LF series sensors also available with 500 mV/g sensitivity (HV100LF-500/HV200LF-500 series sensors).

TRADITIONAL & TRIAXIAL

Retain your test procedures, avoiding rewrites or specification changes, with Wilcoxon's legacy 793 and 797 sensors. Our 993B series of triaxial accelerometers offers 3-axis simultaneous sensing to simplify your monitoring setup, with multiple sensitivities and connector options available.



Wilcoxon model	• 793	• 797	• 993B-7-M12	• 993B series
Sensitivity	100 mV/g	100 mV/g	100 mV/g	25, 50, or 100 mV/g
Sensitivity tolerance	±5%	±5%	±10%	±10%
Frequency response ± 3 dB, Hz	0.5 - 15,000	1.0 - 12,000	2.0 - 10,000 (Z axis) 2.0 - 7,000 (X, Y axes)	2.0 - 10,000 (Z axis) 2.0 - 7,000 (X, Y axes)
Resonance frequency	25 kHz	26 kHz	>35 kHz	>35 kHz
Electrical noise 100 Hz	5 µg/√Hz	5 µg/√Hz	2 µg/√Hz	3.2, 2.0, or 1.4 µg/√Hz
Max temperature	120°C	120°C	120°C	120°C
Bias output voltage	12 VDC	12 VDC	12 VDC	11 VDC
Grounding	case isolated	case isolated	case isolated	case isolated
Mounting	1/4-28 tapped hole	1/4-28 captive screw	10-32 captive screw	10-32 captive screw
Output connector	2-pin MIL-C-5015	2-pin MIL-C-5015	4-pin M12	integral cable, blunt cut
Compliance	CE • [CSA/ATEX/IECEx]	CE • [CSA/ATEX/IECEx]	CE • [CSA]	CE • [CSA]

**LIFETIME
WARRANTY**

**LIFETIME
WARRANTY**

**LIFETIME
WARRANTY**

- Hazardous area certified models available for the 793, 797, 993B-7-M12, and each of the 993B-5, 993B-6, and 993B-7. See [page 23](#) for certification details.

- Radiation-resistant models available for the 793 and 797 (see [Radiation-resistant products on page 22](#)).

HAZARDOUS AREA SENSORS

Wilcoxon offers sensors for use in a variety of hazardous locations to meet both North American and international standards. [Hazardous area sensors on page 23](#) provides a comprehensive list of sensor certifications. In addition to our sensors, Wilcoxon provides a full range of cables, connectors, safety barriers, and other accessories for certified hazardous locations.



» Intrinsic safety

Wilcoxon's IS sensors are designed with 2-fault wiring to meet intrinsic safety requirements, preventing ignition in Class I, Division 1 (Zone 0/1) areas. They hold North American, European and international certifications, making them suitable for use in facilities around the world.



» Explosion-proof

Wilcoxon also offers explosion-proof 4-20 mA vibration sensors for indoor use in Class I areas. See [page 48](#) for a complete list of certified 4-20 mA sensors.



» Class I, Division 2/Zone 2

Sensors certified for Class I, Division 2/Zone 2 areas and for various groups and temperature classes are available, including a wide range of accelerometers, velocity transducers and 4-20 mA sensors.



» Radiation-resistant sensors & cable assemblies

Our 793R, 793VR, and 797R sensors are radiation-resistant up to 1×10^7 RADs, along with cable assemblies with 6QN/QNI connectors and J9T2/J9T2S Tefzel jacketed cable.



View more at buy.wilcoxon.com

HAZARDOUS AREA SENSORS



Model	North American certification	ATEX certification	IECEx certification
780A-IS, 786-500-IS, 786-500-M12-IS, 786A-IS, 786A-M12-IS, 786F-IS, 786T-IS, 787-500-IS, 787-500-M12-IS, 787A-IS, 787A-M12-IS, 787A-M8-IS	Class I Div 1 Groups A B C D; Class II Div 1 Groups E F G; Class III; Class I Zone 0 Ex ia IIC T4; Class I Zone 0 AEx ia IIC T4 Ta = -50° to +120°C	II 1 G Ex ia IIC T4 Ga Ta = 120°C	Ex ia IIC T4 Ga Ta = 120°C
780A-D2, 786-500-D2, 786-500-M12-D2, 786A-D2, 786A-M12-D2, 786F-D2, 786T-D2, 787-500-D2, 787-500-M12-D2, 787A-D2, 787A-M12-D2, 787A-M8-D2	Class I Div 2 Groups A B C D; Class I Zone 2 Ex na II T4; Class I Zone 2 AEx na II T4 Ta = -50° to +120°C	II 3 G Ex nA IIC T4 Gc Ta = 120°C	
LPA100T-D2	Class I Div 2 Groups A B C D; Class II Div 2 Groups E F G; Class III; T5 Class I Zone 2 AEx/Ex nL IIC T5 Ta = -50° to +85°C	II 3 G Ex nA nC IIC T5 Gc Ex ic IIC T5 Gc Ta = -50° to +85°C	
PC420xx-yy-IS PC421xx-yy-IS PC423xx-yy-IS	Class I Div 1 Groups A B C D T3C Ta = 85°C max	II 1 G Ex ia IIC T4 Ga -40° < Tamb < +85°	Ex ia IIC T4 Ga
PC420xx-yy-EX	Class I Div 1, 2 Groups A B C D; Class II Div 1, 2 Groups E F G; Class III T3C Ta = 85°C max	II 2 G Ex d IIC T3 II 3 G Ex nA IIC T3 -40°C ≤ Ta ≤ +85°C	
PCH420V-R6-HZ, PCH420V-M12-HZ	Class I Div 2 Groups A B C D; Class I Zone 2 AEx/Ex nA nC IIC T4 Ta = 105°C max	II 3 G Ex nA nC IIC T4 Gc -40°C < Ta < +105°C	Ex nA nC IIC T4 Gc -40°C < Ta < +105°C

Model	US certification	Canadian certification	ATEX certification
793E, 793LE, 797E, 797LE	CL I, II, III, T4, Div 1 Groups A B C D E F G; Nonincendive for Div 2 Groups A B C D F G		
793VE, 797VE	CL I, II, III, T4, Div 1 Groups C D F G; Nonincendive for Div 2 Groups A B C D F G		
793-33, 793L-33, 793V-33, 793V-5-33, 797-33, 797L-33		Ex ia CL I, Div 1 Groups A B C D	
993B-5-33, 993B-6-33, 993B-7-33		CL I Div 1 Groups A, B, C, D T4A Ta = 85°C max	
993B-7-M12 [CERT]		CL I Div 1 Groups A, B, C, D CL I Div 2 Groups A, B, C, D T4A Ta = 85°C max	
793-10-35, 793-35, 797-35, 797L-35			II 1 G Ex ia IIC T4 Ga Tamb = -50° to +120°C
793V-35			II 1 G Ex ia IIA T4 Ga Tamb = -50° to +120°C

CABLES & CONNECTORS

Wilcoxon offers a wide variety of rugged cables and connectors to ensure data reliability. Several of our most popular cable assemblies in standard lengths are kept in stock, ready to ship, while custom cable assemblies are built to meet your individual requirements.

4 things to consider for cable assemblies

1 Environment

Selecting the right cable assembly is highly dependent on the operating environment. The presence of dusts or liquids determines the right connector IP rating; caustic chemicals, high operating temperatures, and potential for abrasion or damage can affect the choice of cable jacket and/or jacket covering. For the best chemical resistance and high temperature operation, Teflon is usually the best choice. Enviroprene and Tefzel also offer good chemical resistance, and polyurethane is a cost-effective option for less demanding environments. In hazardous locations, you may need to choose a particular cable assembly to meet certification requirements.

2 Interference

This is a concern where there are nearby noise sources that could interfere with the signal as it's run through the cable. Foil shielding blocks high levels of radio frequency (RF) signals, found in wind turbine nacelles or high-speed turbines. Braided shielding minimizes the power line frequencies found around electric motors and offers some protection against RF interference; it's commonly used in industrial applications.

3 Permanent or temporary installation

For permanent installations, straight cables which can be properly secured along the entirety of the run should be used. The cable type should be selected according to the characteristics of the operating environment – not just at the installation point, but of the entire area where the cable will be run. For walkaround applications using a data collector, coiled cables are often preferred for their flexibility. Make sure the connector type is correct for the data collection equipment.

4 Cable length

While 4-20 mA signals can be carried clearly through long cable runs, dynamic vibration signals from accelerometers or velocity sensors can be only sent through about 100 feet of cable without losing signal content. For longer cable runs, consider using shielded cable to minimize interference along the route or installing a switchbox closer to the sensor.

CABLE & CONNECTOR DESIGN

Connector types	
MIL-style	The most common connector used with industrial sensors. Rugged, cost-effective, and available in a variety of boots and sealing methods for use in different environments.
Multi-conductor	Includes LEMO, Bendix, Turck, and M12 style connectors, used on data collectors, multi-axis or dual-output sensors. M12 connectors are common in process applications.
Coaxial	BNC and 10-32 Microdot connectors are 2-pin configurations designed for use with coaxial cables, and reduce the time associated with portable data collection.
Cable types	
Shielded, twisted pair	Permanent sensor installations most often use 2-conductor shielded cable because it minimizes electrical noise and for its compatibility with 2-wire sensors.
Multi-conductor shielded	Multi-conductor shielded cable is used with 3-, 4- or 5-wire sensors because it minimizes electrical noise.
Coaxial	Used with BNC connectors and charge output accelerometers, coaxial cable has an inner conductor which carries power and signal, while the shield acts as signal common. Low-noise mineral insulation cable minimizes triboelectric effects.
Shielding	
Foil	Shielding made of aluminized mylar with a drain wire for electrical connection. The foil blocks high levels of RF signal, often found in wind turbine nacelles or high-speed turbines.
Braided or spiral	Shielding is provided by a braid made from many strands of small gauge wire, wrapped around the cable conductor(s). Braided shielding is considered more effective at minimizing power line frequencies found around electric motors, and tightly wound braid protects against RFI.
Cable protection	
Spiral armored jacket covering	Spiral wrapped solid band of metal surrounding a cable. The armor protects the cable from damage from heavy objects, and improves chemical resistance by isolating the cable from the surrounding atmosphere.
Stainless steel overbraid	Braided electrical shield of stainless steel wrapped along the outside of the cable. The braid protects the cable from sharp objects and can act as an additional signal shield; in submerged applications, it prevents intrusion of foreign objects and does not trap water.
Environmental resistance	
Teflon	The cable jacket of choice for most industrial applications due to its chemical and temperature resistance. Teflon can withstand temperatures up to 200°C, is resistant to most chemicals, and is physically strong, extending cable life.
Enviroprene	A lower-cost Teflon alternative used in standard industrial environments. Enviroprene offers good chemical resistance and protects against common exposures such as UV rays.
Tefzel	Radiation resistance and good chemical resistance make Tefzel the best choice for use in nuclear environments.
Polyurethane	Polyurethane is a low-cost, abrasion-resistant material that's sufficiently durable for use in walkaround routes. It's often used in underwater applications because it can be bonded to metals, creating a watertight seal to the sensor.

CABLE ORDERING GUIDE

Wilcoxon offers custom cable assemblies built to fit the requirements of your application. Our application support team is here to help in selecting the right assembly.

Wilcoxon cable assemblies use the following part number configuration:

R **a** - **b** - **c** - **xx** - **d**

R	Designates cable assembly
a	Mating connector (see page 28)
b	Termination connector (see page 28)
c	Cable type (see page 29 and table at right)
xx	Cable length (ft or m), including connectors
d	Optional: -A: armor -S: stainless steel braid -SC: safety connector



R **6WP** - **2** - **J88C** - **6**

Model 6WP mating connector, model 2 BNC termination connector, J88C cable, 6 ft. length

Connector/cable compatibility		
	Connector	Compatible cables
Coaxial	1	J1, J2, J3, J4, J93
	1A	J1, J2, J3
	2	J1, J2, J3, J4, J5A, J6, J9, J93, J9F, J9T, J9T2A, J9T2AS, J9T2B, J9T3A, J9T4, J10, J10S, J61, J81, J88, J88C
	2F	J5A, J6, J9, J9F, J9T, J9T2A, J10, J61, J81, J93
	6	J3, J4, J5A, J6, J9, J9F, J9T, J9T2, J9T2S, J9T2A, J9T2AS, J9T2B, J10, J51, J61, J81, J88, J93
MIL-C-5015 style	6D2	J9T2A, J9T2AS, J9T2B, J10, J88C
	6Q / 6QI	J5A, J9T, J9T2, J9T2A, J9T2AS, J9T2B, J10, J10S, J51, J61, J88, J88C
	6QA / 6QAI	J9F
	6QN / 6QNI	J9T2, J9T2S
	6GD2	J9T3A, J12
	6GQ / 6GQI	J9T3A
	6GSL / 6GSLI	J9T3, J9T3A
	6GW	J9T3A
	6H / 6HI	J3, J9T2A, J9T2AS, J10
	6HD2	J9T2A, J10
	6SL / 6SLI	J5A, J9, J9T, J9T2, J9T2S, J9T2A, J9T2AS, J9T2B, J10, J61
	6W	J5A, J9F, J9T2, J9T2S, J9T2A, J9T2AS, J9T2B, J10
	6WP	J88, J88C
	6WR	J5A, J9F, J9T2A, J9T2B, J10
	9W	J9T2S, J9T4, J9T4A, J9T4B, J84
19SL / 19SLI	J9T3PS, J9T4, J9T4A, J95	
M12 style	M12P	J9T4A, J9T4B, J10, J84, J84C, J88
	M12S	J9T2S, J9T2A, J9T4A, J10, J12, J84, J84C
	45	J10, J12, J84, J84C, J88, J88C
	75S	J9T2A, J9T2S, J9T4A, J10, J12, J84, J84C

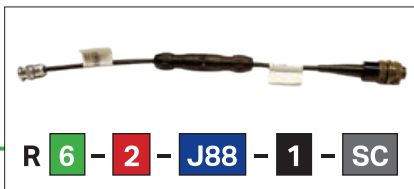

R **6** - **2** - **J88** - **1** - **SC**

6 mating connector, 2 termination connector, J88 cable, 1 ft. length, safety connector

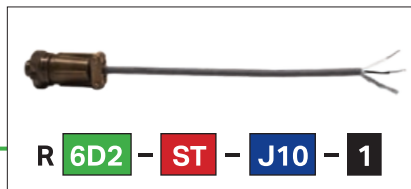

R **6D2** - **ST** - **J10** - **1**

M12 mating connector, stripped and tinned at other end, J10 cable, 1 ft. length

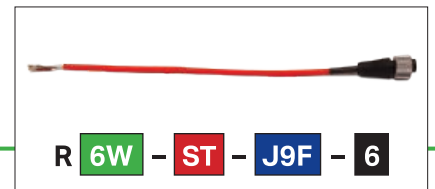

R **6W** - **ST** - **J9F** - **6**

6W mating connector, stripped and tinned at other end, J9F cable, 6 ft. length

STANDARD CABLE ASSEMBLIES

Our most popular cable assemblies are kept in stock, ready to ship. With several standard lengths, connectors with a variety of IP ratings and pinouts, and high temperature Teflon jacketed cables with optional cable protection, our standard assemblies make it simple to get the job done.

Wilcoxon model	R6Q-0-J9T2A-XX	R6WP-2-J88C-XX	R6W-0-J9F-XX	RM12W-0-J10-XX
Mating connector	2 socket MIL-C-5015, high temp Viton B	2 socket MIL-C-5015, molded	2 socket MIL-C-5015, molded	5 socket M12, molded
Connector IP rating	IP68	IP65	IP67	IP67
Termination connector	Blunt cut	BNC	Blunt cut	Blunt cut
Cable shielding	Twisted, shielded pair	Twisted, shielded pair	Foil shielded, drain wire	Twisted, shielded pair
Cable jacket	Yellow Teflon	Black polyurethane, coiled	Red Teflon	Gray Enviroprene
Cable jacket covering	none	none	none	none
Max cable temperature	200°C	80°C	200°C	125°C
Cable lengths	10, 16, 32, 64 ft. (3, 5, 10, 20 m)	6, 10, 16 ft. (2, 3, 5 m)	10, 16, 32, 64 ft. (3, 5, 10, 20 m)	16, 32, 64 ft. (5, 10, 20 m)

Wilcoxon model	R6W-0-J9T2A-XX	R6W-0-J9T2AS-XX	R6WR-0-J9T2A-XX	R6WR-0-J9T2AS-XX
Mating connector	2 socket MIL-C-5015, molded	2 socket MIL-C-5015, molded	2 socket MIL-C-5015, molded, right angle	2 socket MIL-C-5015, molded, right angle
Connector IP rating	IP67	IP67	IP67	IP67
Termination connector	Blunt cut	Blunt cut	Blunt cut	Blunt cut
Cable shielding	Twisted, shielded pair	Twisted, shielded pair	Twisted, shielded pair	Twisted, shielded pair
Cable jacket	Yellow Teflon	Yellow Teflon	Yellow Teflon	Yellow Teflon
Cable jacket covering	none	Stainless steel overbraid	none	Stainless steel overbraid
Max cable temperature	200°C	200°C	200°C	200°C
Cable lengths	10, 16, 32, 64 ft. (3, 5, 10, 20 m)	10, 16, 32, 64 ft. (3, 5, 10, 20 m)	10, 16, 32, 64 ft. (3, 5, 10, 20 m)	10, 16, 32, 64 ft. (3, 5, 10, 20 m)



CONNECTORS

R **a** - **b** - **c** - **xx** - **d**





Model	Connector	Description	Max temp	Field assembly	IP rating
6	2 socket MIL-C-5015	Amphenol, metallic	125°C	Yes	50
6D2		Class I, Div 2 suitable	125°C	No	67
6GD2	3 socket MIL-C-5015		Viton® B boot	125°C	No
6GQ / GQI*		200°C		Yes	68
6GSL / GSLI*		125°C		Yes	67
6H / 6HI*	2 socket MIL-C-5015	Potted backshell, HART-compatible	125°C	No	67
6HD2 / 6HD2I*		HART-compatible, Class I, Div 2 suitable	125°C	No	67
6Q / 6QI*		High temp Viton® B boot	200°C	Yes	68
6QN / QNI*		Radiation resistant, Neoprene boot	105°C	Yes	68
6SL / SLI*		Viton® B boot	125°C	Yes	67
6W		Isolated shield, molded	125°C	No	67
6WR		Right angle, isolated shield, molded	125°C	No	67
6WP	Isolated shield, molded, improved strain relief	125°C	No	65	
1	Microdot 10-32 coaxial	Straight plug	200°C	No	50
1A		Right angle	200°C	No	50
2 / 2F	BNC	Male / female	165°C	No	50
M12W	M12	5 socket, molded	125°C	No	67
M12S		5 socket	85°C	No	67
45		5 pin, Turck	85°C	No	67
75S		5 socket	85°C	No	67
9W	4 socket MIL-C-5015	Threaded, waterproof Bendix	125°C	No	50

* I indicates electrical isolation between shield and transducer housing.

CABLES

R a - b - c - xx - d



Model	J9T2A 	J9T2AS 	J9T2	J9T2S	J9T2B	J10	J10S
Conductors	twisted, shielded pair						
Description	Yellow Teflon® jacket	Yellow Teflon jacket, stainless steel braid	White Tefzel® jacket	White Tefzel jacket, stainless steel braid	Blue Teflon jacket for IS wiring requirements	Gray Enviro-prene® jacket	Gray Enviroprene jacket, stainless steel braid
Max temp.	200°C	200°C	150°C	150°C	200°C	125°C	125°C
Diameter	0.190 in.	0.210 in.	0.190 in.	0.210 in.	0.190 in.	0.190 in.	0.210 in.
Capacitance	27 pF/ft	27 pF/ft	27 pF/ft	27 pF/ft	27 pF/ft	30 pF/ft	30 pF/ft

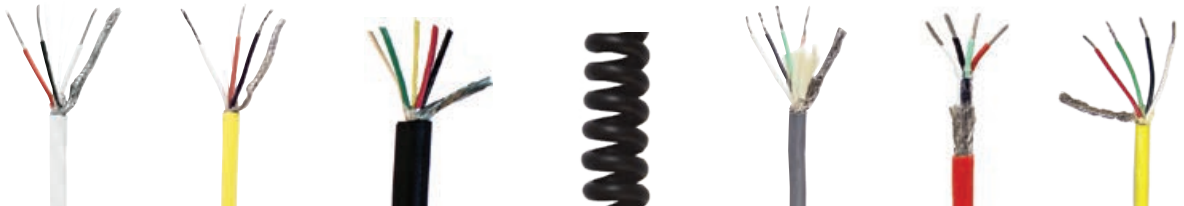

Model	J9T3	J9T3A	J84	J84C	J12	J9T4	J9T4A
Conductors	3 conductor		4 conductor				
Description	White Tefzel jacket	Yellow Teflon jacket, stainless steel braid	Black polyurethane jacket, Kevlar® reinforced	Black polyurethane jacket, coiled, Kevlar reinforced	Gray Enviro-prene jacket	Red Teflon jacket	Yellow Teflon jacket
Max temp.	150°C	200°C	80°C	80°C	125°C	200°C	200°C
Diameter	0.190 in.	0.190 in.	0.210 in.	0.210 in.	0.190 in.	0.190 in.	0.190 in.
Capacitance	27 pF/ft	27 pF/ft	44 pF/ft	44 pF/ft	30 pF/ft	30 pF/ft	27 pF/ft



Model	J95	J88	J88C	J9F	J1	J3	J5A
Conductors	5 conductor	twisted, shielded pair			coaxial		
Description	Shielded, black polyurethane jacket	Black polyurethane jacket	Black polyurethane, coiled with 6" straight ends	Red Teflon jacket, foil shielded with drain wire	Orange PVC jacket, low noise	Red Teflon jacket, low noise, high temp	Black PVC jacket, RG 58
Max temp.	90°C	80°C	80°C	200°C	80°C	260°C	105°C
Diameter	0.240 in.	0.175	0.175 in.	0.174 in.	0.088 in.	0.085 in.	0.190 in.
Capacitance	22 pF/ft	60 pF/ft	60 pF/ft	51 pF/ft	30 pF/ft	30 pF/ft	30 pF/ft

CABLE CONSIDERATIONS

Cable length

An accelerometer cable can be run 100 feet without losing signal content. The maximum length is a function of supply current and the highest frequency of interest. The graph at right helps determine maximum cable lengths.

Note: Graph values assume cable capacities of 30 pF/ft and an available swing of 5 V p-p. The current available is represented by I.

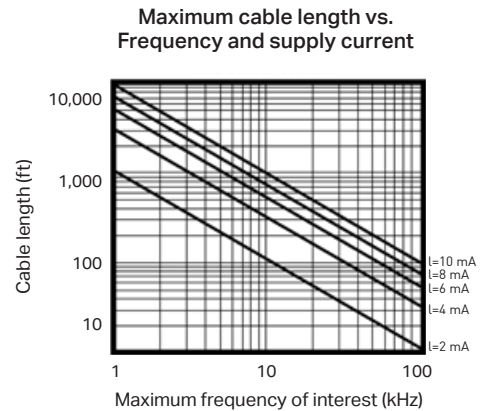

IP ratings

Protection against solids		Protection against liquids	
No protection	0	0	No protection
Objects >50 mm	1	1	Vertically dripping water
Objects >12.5 mm	2	2	Angled dripping water
Objects >2.5 mm	3	3	Sprayed water
Objects >1.0 mm	4	4	Splashed water
Dust-protected	5	5	Water jets
Dust-tight	6	6	Pressure jets
		7	Immersion to 1 meter
		8	Indefinite immersion

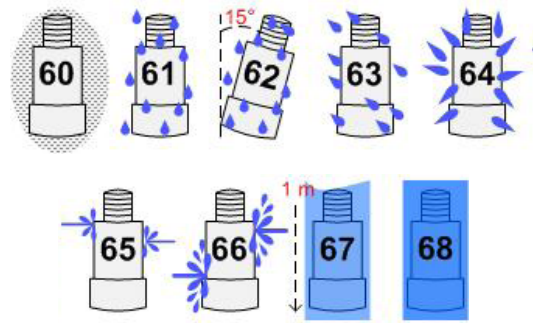

IP ratings – protection against liquids

Avoiding ground loops

Ground loops develop when a common line (signal return/shield) is grounded at two points of differing electrical potential. For sensors using two-conductor shielded cable, the signal and power are carried on one lead and the signal common on the other. The cable shield serves to protect the signal from electrostatic discharge (ESD) and electromagnetic interference (EMI). The shield should be grounded at only one point, normally at the readout equipment.

In all cases, it's crucial that the cable shield terminations be properly grounded to avoid damage to sensor electronics from high ESD/EMI environments. Choosing a single point for your ground also greatly increases the ability of the shield to protect against RF interference.

Visit wilcoxon.com/resources for more tech tips.

MOUNTING ACCESSORIES

Wilcoxon offers a wide range of mounting hardware and accessories for both permanent and temporary sensor installations. Evaluation of the mounting location of each sensor must be based on the specific machine and vibration source to be monitored. The mounting configuration depends primarily upon dynamic measurement requirements, such as frequency and amplitude range.

5 things to consider for sensor mounting

1 Permanent or temporary installation

For permanent installations, stud mounting or cementing pads are the preferred options, and also provide better frequency response. For temporary installations, magnets for both flat and curved surfaces are available.

2 Dynamic measurement requirements

The closer the contact between sensor and machine, the better the ability to couple and measure high frequencies. Adhesives, cementing pads, or stud mounting are best for high frequency or high amplitude vibrations.

3 Mounting locations

Determine where sensors should be mounted on the machine to capture the data you want. Choose a location that minimizes the vibration transmission route through the machine.

4 Mounting surface

Correct surface preparation is crucial for accurate measurements. Always try to ensure flush mounting. SILGREASE can be used for improved frequency response. 2-pole magnets are for use on curved surfaces; use flat magnets on flat surfaces.

5 Effect on measurement results

Always aim for the closest possible contact between sensor and machine, and be consistent with placement when using magnets or probe tips. Proper mounting ensures the most reliable data.

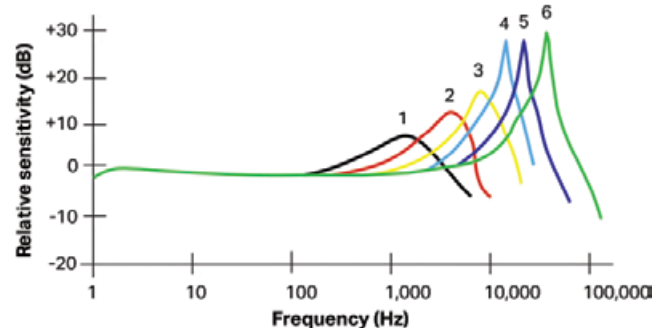
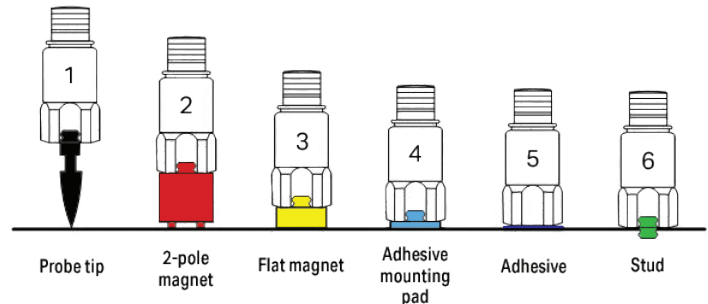

STUDS AND CEMENTING PADS

Threaded stud mounting allows the widest dynamic measurement range and is recommended for permanent monitoring systems, high frequency testing, and harsh environments.



Mounting studs					
	SF1	SF3	SF6	SF6M	SF6M-1
	0.26" length 10-32 UNF both ends Stainless steel	0.32" length 10-32 to 1/4-28 Stainless steel	0.375" length 1/4-28 UNF both ends Stainless steel	0.53" length 1/4-28 UNF to M8x1.25 Stainless steel with black oxide coating	0.39" length 1/4-28 UNF to M6x1 Stainless steel with black oxide coating

Isolator mounting bases				
	SF21	SF22	SF23	SF24
	1.0" hex across flats Mounting surface diameter: 0.82" Isolation protection up to 1,500 volts 1/4-28 to 1/4-28 integral stud	1.0" hex across flats Mounting surface diameter: 0.82" 1/4-28 to M8 integral stud	1.125" hex across flats Mounting surface diameter: 0.94" 1/4-28 to 1/4-28 integral stud	1.125" hex across flats Mounting surface diameter: 0.94" 1/4-28 to M8 integral stud

Cementing pads can approach the high frequency capabilities of stud mounts, without the need for drilling into the structure.

Cementing pads					
	SF8		SF8-2		SF8-8
	1/4-28 integral stud 1.0" diameter Stainless steel		1/4-28 tapped hole 1.0" diameter Stainless steel		10-32 hole, keyed for use with 993B triaxial sensors 1.0" diameter Stainless steel









Three accelerometers can be mounted to the TC series triaxial mounting cubes for simultaneous measurements along three orthogonal directions (x, y, z).

Triaxial mounting cubes					
	TC1		TC1B		TC2
	10-32 tapped holes, 1.00" each side		1/4-28 tapped holes, 1.00" each side		3/8-16 tapped holes, 2.60" each side

Go to buy.wilcoxon.com for our full range of mounting hardware and accessories.

MAGNETIC MOUNTS

Magnetic bases are a quick and convenient option for portable walkaround applications and are often used on large machinery. They can be quickly attached and removed on both flat and curved surfaces. All Wilcoxon magnets are designed with corrosion-resistant stainless steel casings.

Two-pole magnetic mounting bases			
	MD035 1.00" diameter 35 lb force 1/4-28 tapped hole non-isolated		MD055 1.25" diameter 55 lb force 1/4-28 tapped hole non-isolated
			MD130 2.00" diameter 130 lb force 1/4-28 tapped hole non-isolated
Flat magnetic mounting bases			
	MF040 1.00" diameter 40 lb force 1/4-28 tapped hole, non-isolated		MF075 1.25" diameter 75 lb force 1/4-28 tapped hole non-isolated
			MF120 1.50" diameter 120 lb force 1/4-28 tapped hole non-isolated
Two-pole magnetic mounting bases for triaxial sensors			
	MT075 1.50" diameter, 75 lb force, 1/4-28 tapped hole, non-isolated		MT075A 1.50" diameter, 75 lb force, 10-32 tapped hole, non-isolated
Magnet landing pad			
	SF11 1.00" diameter provides surface for sensor attachment using a magnetic mounting base		

MOUNTING ACCESSORIES

VERSIL406 mounting epoxy
150°C max temperature, mounts approximately 5 sensors/mounting pads.

SILGREASE
Non-toxic mounting grease, radiation-resistant and electrically insulating.

ST101 spot face tool
1.25" diameter, pilot drill for 1/4-28 tapped hole, drill depth adjustable.

PT2 probe tip
Stainless steel, connects to handheld vibration meter for quick readings in hard-to-reach areas.



ENCLOSURES

Enclosures serve as a central data collection point and streamline workaround routes. Designed with the user in mind, they enable quick and safe data acquisition. Wilcoxon offers a variety of customizable enclosure options compatible with single-output, dual-output, and triaxial sensors to meet the requirements of your application.

4 things to consider when selecting an enclosure

1 Number of sensors

The number of channels and overall size selected will depend on how many sensors are being run to the enclosure. Base size models can support up to 12 sensors. Expandable size models have the capacity for up to 48 channels, allowing the option of future expandability.

2 Sensor outputs

The number of sensor outputs determines the type of enclosure you need. Choose VLL or VLS models for single-output sensors, VLD models for dual-output (vibration and temperature) sensors, and VLT models for triaxial sensors.

3 Bringing the signal out

How is the data from the enclosure being collected? If it will be permanently wired to an online system, choose a VLS or VLD model with online connectivity. In route-based data collection, any VLL, VLS, or VLD model without online connectivity is a better option; opt for removable plugs if it may be needed in the future.

4 Safety

For route-based programs, safety should always be a factor. A central data collection point not only saves time; installing the enclosure in a safe location allows analysts to avoid single sensor installations near safety hazards and can reduce risks to personnel.

VIBRALINK® (VL) SERIES

VLS / VLD

VLS and VLD switchboxes allow the user to choose between single or dual vibration/temperature output, and feature an industry-first data ready LED that indicates when BOV levels have stabilized. Decrease active collection time, eliminate ski-slope data and increase efficiency in data collection.

- » Base or expandable enclosure size for up to 48 channels
- » Compatible with single- or dual-output IEPE sensors
- » Online connectivity for continuous monitoring
- » Organized terminals for clean cable runs
- » Customizable cable access holes
- » 55% more interior space
- » NEMA 4/4X and IP66 ratings
- » Increased noise immunity

Industry first

Data ready light

unbeatable accuracy,
reliable readings



Configurable options

VLS and VLD enclosures are available with a wide variety of features to meet the requirements of different applications. See [VLS / VLD configuration on page 36](#) for a complete part numbering guide.

VLL

Wilcoxon's new VibraLINK Lite (VLL) enclosures are a cost-effective solution where simplicity of design fulfills your requirements. Designed for use with single-output sensors and with many of the same configurable features of VLS models, VLL enclosures can be tailored to a variety of industrial applications. See [VLL configuration on page 36](#) for part numbering information.



VIBRALINK® (VL) SERIES CONFIGURATION

VLS / VLD configuration

VL **X** **#** **Y** **a** - **b** - **cc** - **d**

- | | | | |
|-----------------------------------|-----------------------|------------------------------------|---------------------|
| X <input type="checkbox"/> | Single or dual output | a <input type="checkbox"/> | Material |
| # <input type="checkbox"/> | Number of channels | b <input type="checkbox"/> | Cable interface |
| Y <input type="checkbox"/> | Enclosure size | cc <input type="checkbox"/> | Online connectivity |
| | | d <input type="checkbox"/> | Terminal type |

VLS / VLD configuration options		
X	S : single-output (vibration) D : dual-output (vibration + temp)	
# of channels	6, 8, 12	12, 24, 36, 48
Y (inches)	B = 10 x 8 x 4"	E = 20 x 16 x 8"
a	F : fiberglass S : stainless steel	
b	C : conduit G : cable grip	
cc	N : no online connectivity OC : conduits OG : cable grips OP : removable plugs*	
d	S : screw Q : quickconnect	

* For future use for online connectivity.

VLL configuration

VLL **#** **Y** **a** - **b** - **N** - **S**

- | | | | |
|-----------------------------------|--------------------|-----------------------------------|-----------------|
| # <input type="checkbox"/> | Number of channels | a <input type="checkbox"/> | Material |
| Y <input type="checkbox"/> | Enclosure size | b <input type="checkbox"/> | Cable interface |

VLL configuration options		
# of channels	6, 8, 12	12, 24, 36, 48
Y (inches)	B = 10 x 8 x 4"	E = 20 x 16 x 8"
a	F : fiberglass S : stainless steel	
b	C : conduit G : cable grip	
N	N : no online connectivity	
S	S : screw terminals	



Model VLS24EF-G-N-S



Model VLS12BF-G-OG-S

VL series comparison

Feature	VLL	VLS	VLD
Rotating channel selector switch	X	X	X
Accepts 6-12 sensor inputs (base size)	X	X	X
Accepts 12-48 sensor inputs (expandable size)	X	X	X
Available in fiberglass or stainless steel	X	X	X
Selectable cable grip or conduit cable interface	X	X	X
Designed for use with single-output IEPE sensors	X	X	
BNC output connector (for data collection)	X	X	
2-pin MIL-C-5015 output connector (for data collection)		X	
Industry first data-ready light		X	X
Optional online connectivity pass-through terminals		X	X
Designed for use with dual-output (vibration + temp) IEPE sensors			X
3-pin MIL-C-5015 output connector (for data collection)			X

JUNCTION BOXES

VLT enclosures

VLT models offer simple configuration and are designed for use with triaxial sensors.

- » 6 channels
- » Stainless steel or fiberglass housing
- » Cable grips or M12 connectors (for compatibility with data collectors)
- » NEMA 4/4X rated for harsh industrial environments



Cable termination boxes

Low-cost, compact CB series models provide compatibility with data collectors and are rated for indoor applications.

- » Model CB2: 2 channel BNC, termination junction box, cable grips
- » Model CB4: 4 channel BNC, termination junction box, cable grips



INSTRUMENTATION

Wilcoxon's handheld devices enable economical entry into vibration data collection or a way to expand existing programs' capabilities. From convenient handheld meters that provide need-to-know information in the field to reference sources that enable entire measurement chain verification, Wilcoxon offers a comprehensive selection of instrumentation to fit your plant's needs.

MAC800 HANDHELD VIBRATION METERS

Wilcoxon's easy-to-use MachineryMate® meters record, analyze, and display vibration values color-coded to ISO 10816-3 alarm levels, enabling quick and reliable machinery health monitoring. Built-in filter bands provide a clear picture of machine problems such as unbalance, misalignment, and looseness.



MachineryMate kits			Accessories
MAC800	MAC810	MAC820	
X	X	X	MAC800 meter and DataMate software
X	X	X	USB docking cradle
X	X	X	Protective boot
X	X	X	100 mV/g sensor with magnet
X	X	X	Carrying case
	X	X	Strobelight attachment
	X	X	DataMate PRO software
		X	Bluetooth headphones
		X	Headphones case

INTRINSICALLY SAFE HANDHELD METERS

The new MAC800-IS meters are certified for use in Class I, Division 2 and Class I, Zone 1 hazardous locations, making it easier to monitor all your machines. They offer all the functionality of the standard MAC800, with built-in filter bands and a color-coded display.

Features

- » IECEx/ATEX certified for Class I, Zone 1 hazardous locations internationally
- » SGS certified for Class I, Division 2 locations in North America
- » Includes DataMate software for analysis of vibration data from multiple measurement points
- » Quick verification of vibration levels on critical machines, even in hazardous areas
- » Includes intrinsically safe accelerometer and compatible cable assembly



Certifications

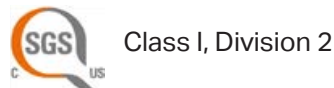
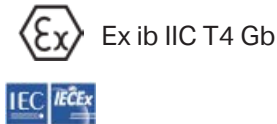

COMPLETE SOLUTIONS FOR WALKAROUND MONITORING



Whether you're in charge of a growing vibration monitoring program that requires technicians to make real-time decisions on machinery maintenance requirements, or tasked with verifying the operation of an existing condition monitoring program, Wilcoxon has the full range of tools you need to see the job through.

- » Portable vibration meters and handheld shakers
- » Triaxial sensors and general purpose accelerometers
- » Magnetic mounts for flat and curved surfaces
- » Data collector cables
- » New molded connectors with 2-pin MIL-C-5015 and M12 options

MAC800 HANDHELD VIBRATION METERS

All MachineryMate kits include the MAC800 meter, DataMate software, a general purpose accelerometer with magnet mount, and a carrying case. MAC810 and MAC820 kits include an upgrade to DataMate PRO for expanded monitoring capabilities, an asset in larger facilities with online monitoring systems. Bluetooth headphones are available in the MAC820 kit for analysts who can diagnose machine problems via audio.

DataMate® software

DataMate is the powerful vibration analysis software tool designed for use with the MAC800 vibration meter.

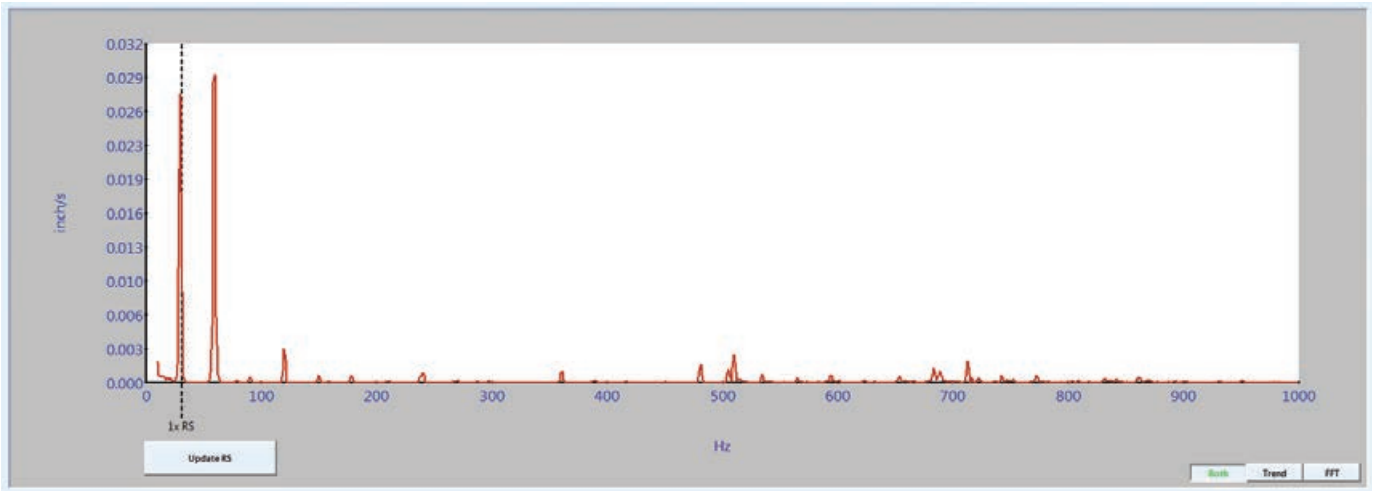

The standard DataMate software supports up to 10 machines, with 10 individual points per machine, while DataMate PRO allows monitoring of up to 1,000 machines. It works across computer networks to allow access to remote databases and readings that are stored on other computers. This advanced feature enables users to monitor machinery at more than one site.

MAC accessories



780FM-2-J88C compact, integral cable sensor with magnet



MAC003 carrying case



MAC004 strobelight attachment for verifying run speed



MAC006 Bluetooth headphones for audio analysis

REF2510R PORTABLE REFERENCE SOURCE

Quickly and easily check operation and set-up of sensors in the field. With a built-in reference accelerometer maintaining a 1 g test level at three different frequencies, the REF2510R offers a way to check acceleration, velocity, and displacement measurements with no imperial-metric conversions. Operational frequency and measurement type (peak or RMS) can be selected with the push of a button.

Features

- » 3 user-selectable operational frequencies: 61.4 Hz, 100 Hz, 159.2 Hz
- » Switch-selectable RMS or peak
- » Up to 40 hours of battery life
- » Protective thermoplastic boot
- » Max load: 8.8 oz (250 grams)
- » 130°F (55°C) maximum operating temperature

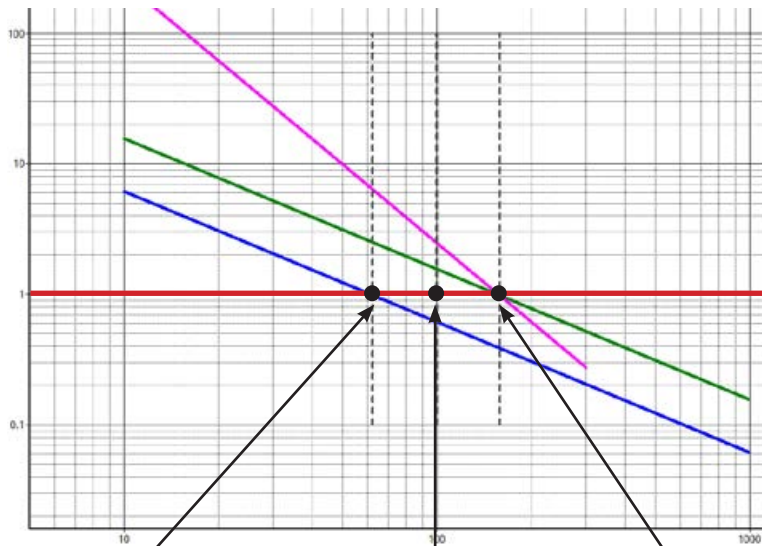

61.4 Hz for imperial measurements
1 g = 1 ips

159.2 Hz for metric measurements
 $9.81 \text{ m/s}^2 = 9.81 \text{ mm/s} = 9.81 \mu\text{m}$

100 Hz to verify standard calibration sheet values

- Constant displacement, μm —
- Constant velocity, mm/s —
- Constant velocity, ips —
- Constant acceleration, g —

ACCESSORIES



TAA01
triaxial adapter



REF001
metric mounting kit



REF002
metric mounting kit

PORTABLE POWER SUPPLIES

Dynamic sensors requiring IEPE power utilize industry-standard CCD power supplies. The power supply contains a voltage source with CCD sufficient to support sensor installations using several hundred feet of cable. Options include battery- or AC-operated, selectable integration, gain, or triaxial configurations. Model P31 is a low-noise power unit/amplifier designed for use with the 731A seismic accelerometer.

Wilcoxon model	P702B	P703B	P704B	P31
Channels	1	3	1	1
Power	(3) 9V batteries	(3) 9V batteries	(3) 9V batteries	(2) 9V batteries
Filter	Selectable	-	-	Selectable
Amplifier gains	1x, 10x, or 100x	-	-	1x, 10x, or 100x
Output	Acceleration or velocity	Acceleration	Acceleration	Acceleration or velocity



P702B



P703B



P704B



P31 with 731A accelerometer

TEMPORARY MOUNTING

For a walkaround monitoring program, magnetic mounts are a must. We offer magnets for flat and curved surfaces, for use with sensors of all sizes, and a full range of accessory equipment.



Machinery fault reference guide

Type of machine	Frequency of disturbance	Plane of vibration	Related symptoms	Frequent causes	Corrective actions	Indicated level for concern
Rotating motors, generators	1x base RPM	Radial	Steady or increases with rotational speed	Rotor unbalance	Common problem: check dynamic balance of main motion	0.05 - 0.2 in/sec-pk
Electric motor	Erratic	Axial	Unsteady vibration reading	Motor misalignment	Check alignment and leveling	Unsteady
Rotating - 2 or more units	Very low	Radial (depends on mounting form)	Level may vary and exhibit beat characteristics	Interaction due to non-synchronous operation of 2 units very close in rotational frequency	Isolate and dampen sources	0.05 - 0.2 in/sec-pk
Couplings, shafts and bearings	2x base RPM (sometimes 1x or 3x)	Usually axial, sometimes radial	High operating temperatures, noise	Misaligned couplings or shaft bearings	Check alignment tolerances - if shaft is bent, vibration will be at base speed	0.05 - 0.2 in/sec-pk
Sleeve bearings	50-100x RPM	Radial	Random in nature, distributed over wide frequency range; may excite critical shaft resonance 1-2x RPM; may overheat	Defective bearings, excessive friction	Replace bearings	0.05 - 0.2 in/sec-pk
	1/2 base RPM	Radial	Disappears when speed drops	Oil whirl in lubricated bearings	Check for excessive clearance or insufficient bearing loads	0.05 - 0.2 in/sec-pk
Ball bearings	High multiple of base RPM	Radial	Readings may be unsteady; spikes indicated pitted balls	Worn balls; rough races; poor lubrication	Check, lubricate or replace bearings	0.1 - 0.5 in/sec-pk; erratic
Gears	1x RPM of: number of teeth × RPM or gear ratio	Radial or torsional	May excite structure resonance	Chipped gear; eccentric gear path circle	Inspect gear; replace or correct eccentricity	0.1 - 0.5 in/sec-pk
Belts	1x base RPM	Axial and radial	Readings may be unsteady	Belts misaligned, mismatched or in resonance	Check alignment, dampen vibration or replace belts	0.1 - 0.5 in/sec-pk
Fans and impellers	1x base RPM or blade passing frequency	Axial and radial	Frequency will vary with speed	Possible design or proximity problem	Relocate, change blade distance, clean blades, check for imbalance	0.1 - 0.5 in/sec-pk
Pumps	0.5 shaft RPM	Radial	Flow rate problems; recirculation; impeller wear	Turbulence/vortexing	Check for cavitation	0.1 - 0.5 in/sec-pk
	10-40x RPM	Axial and radial	Noise; turbulence; high vibration that appears random	Cavitation	Insufficient pressure: take offline and regulate process	0.1 - 0.5 in/sec-pk

COMPLETE PROCESS SOLUTIONS

Continuously trending 4-20 mA vibration data allows you to monitor a variety of machines and detect warning signs prior to equipment failure, without the need for detailed spectrum analysis or specially trained personnel. Direct output to an existing control system makes it simple to establish or improve a cost-effective condition-based monitoring program even if you're not a vibration expert.

4 things to consider for process control systems

1 Output and measurement types

4-20 mA outputs can be proportional to acceleration, velocity, or less commonly displacement. Generally, the ISO 10816-3 standard is used to determine which to use for your application, but some facilities have monitoring practices in place that establish a preferred output type. The measurement can be in terms of RMS or peak, and the choice of measurement type depends on what your system is programmed to accept and what's recommended by established monitoring practices in your facility.

2 Overall vibration level

Since 4-20 mA sensors are designed for simple trending of overall vibration levels, it's especially important to know the machine's baseline so you can avoid saturating the signal. The baseline amplitude is recommended to be 15-20% of the sensor's full scale range to allow for increased vibration and headroom for potential alarm and shutdown setpoint trips. If baseline amplitude is unknown, a configurable transmitter and test sensor can be used for trial-and-error calculations.

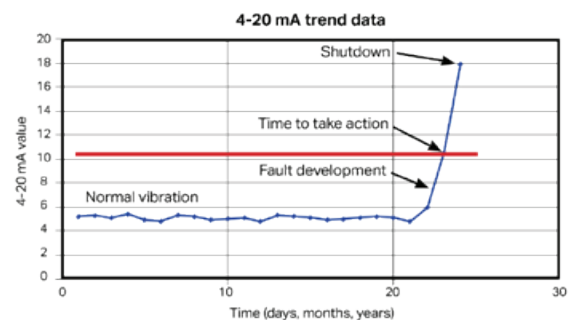

3 Monitoring system

Make sure your monitoring system is equipped to handle a 4-20 mA signal! It might sound obvious, but you don't want to be stuck with great new sensors and no way to use them. Keep an eye out for HART-compatible systems, where a PCH420V sensor can provide more features than just the 4-20 mA overall signal.

4 Environments and requirements

As with all sensor installations, characteristics of the operating environment—including temperature, moisture levels, possible contaminants, and nearby sources of interference—must be taken into account. Use the same considerations when selecting the cabling and mounting method as well. If the installation point is in a classified hazardous location, be sure that the sensor and cable have the appropriate certification.

Monitoring options for process control systems

4-20 mA vibration data can be easily incorporated into existing monitoring programs. Depending on the existing plant infrastructure and the machinery to be monitored, there are several options for a vibration monitoring setup.

4-20 mA sensors

For plants already using PLC/DCS/SCADA systems, the most cost-effective option is the use of 4-20 mA sensors that output directly to the control system. It's simple to do with existing infrastructure and provides 24/7 monitoring at the lowest relative cost per data point. A 4-20 mA sensor used with an alarm module is a good choice for plants without control systems in place. Process display meters can be used similarly, or can be programmed to output to a process control system.



Accelerometers and velocity transducers

While 4-20 mA trend data is useful, dynamic vibration data (the frequency spectrum) is more important in determining the cause of increased vibration. Low frequency measurements, HFD, and transient spikes in vibration from loose components or cavitation are best monitored with accelerometers or velocity transducers in combination with an iT transmitter. This allows for 4-20 mA data to be sent to a control system, alarm module, or display meter without losing the raw vibration data necessary for diagnosing complex machine problems or portable data collection.

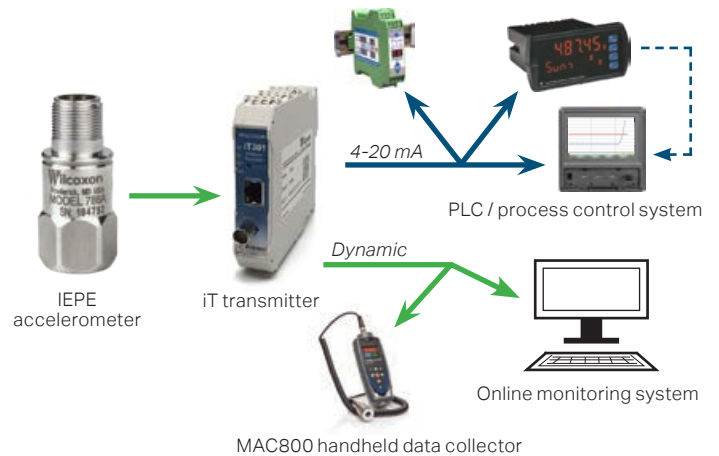

CBM approach	Relative cost per data point	Dynamic data	24/7 continuous monitoring	Required		Advance warning
				PLC/DCS/SCADA	Programming/Training	
PC420 to control system	\$	no	yes	yes	yes/no	1-3 months
PC420 + iT401 alarm module or PCD	\$\$	no	yes	no	no/no	1-3 months
IEPE sensor + iT300	\$\$	yes	yes	yes	yes/no	1-4 months
IEPE sensor + iT300 + iT401 or PCD	\$\$\$	yes	yes	optional	yes/no	1-4 months
Portable data collection	\$\$\$\$\$	yes	no	no	yes/yes	1-6 months
Traditional online monitoring	\$\$\$\$\$\$\$\$	yes	yes	no	yes/yes	3-18 months

4-20 mA SENSORS

4-20 mA sensors represent vibration levels by a loop current of 4-20 mA. As part of a continuous monitoring setup, 4-20 mA trend data can be easily compared against standard vibration guides to indicate general machine health.



Wilcoxon model	• PC420A	• PC420V	PCC421A	PCC421V
Loop output options	RMS, peak, true peak*	RMS, peak	RMS, peak	RMS, peak
Acceleration scaling, g	5, 10, 20, 50	-	5, 10, 20	-
Velocity scaling, ips	-	0.5, 1.0, 2.0, 3.0, 5.0	-	0.5, 1.0, 2.0, 3.0, 5.0
Frequency range	1.0 Hz - 2.0 kHz	3.5 Hz - 2.0 kHz	1.0 Hz - 2.0 kHz	3.5 Hz - 2.0 kHz
Max temperature	105°C	105°C	105°C	105°C
Grounding	case isolated	case isolated	case isolated	case isolated
Mounting	1/4-28 tapped hole	1/4-28 tapped hole	1/4-28 captive screw or M6 captive screw	1/4-28 captive screw or M6 captive screw
Output connector	2-pin MIL-C-5015	2-pin MIL-C-5015	2-pin MIL-C-5015 or 4-pin M12 (integral cable: PCC423A)	2-pin MIL-C-5015 or 4-pin M12 (integral cable: PCC423V)
Compliance	CE • [CSA/ATEX/IECEX]	CE • [CSA/ATEX/IECEX]	CE	CE



- Hazardous area certified models available for PC420A and PC420V series sensors. See page 48 for certification details.
- * 50 g scaling not available on true peak models. Max temperature on true peak models is 85°C.



Wilcoxon offers model PC420DPP-40, a 4-20 mA displacement sensor ideal for monitoring low speed components which produce frequencies close to 1x running speed and aid in detecting machine imbalance or other low frequency faults.

- » RMS output, full scale: 40 mils peak-peak
- » Frequency range: 4 Hz - 2 kHz
- » 85°C max temperature, case isolated, 2-pin MIL-C-5015 connector

Monitored machinery in process applications



Motors

As primary components of industrial processes, motors offer the best opportunity for plants to minimize unscheduled downtime and reduce maintenance costs. A single PC420V velocity output sensor mounted on each bearing can warn of a change of condition which could ultimately lead to further issues on coupled machinery.



Pumps

Detection of cavitation can warn of process irregularities, minimize damage, and reduce downtime and repair costs. Wilcoxon's acceleration true peak sensor provides a quick-response 4-20 mA output signal when cavitation conditions begin. As cavitation continues, the output is driven even higher, providing ample warning of the destructive condition.



Fans

4-20 mA vibration sensors located on pillow blocks of forced draft, induced draft, or HVAC fans can monitor bearing conditions including normal wear, early stage bearing fault, foundation looseness, and fan balance. Detecting failures before damage to surrounding ductwork occurs can save in repair costs.



Cooling towers

Cooling towers can be monitored using 4-20 mA analog input channels of PLC units. The selection of the appropriate 4-20 mA sensor can help to monitor fan balance, gear mesh frequencies, or bearing condition long before catastrophic failure. Fans running below 300 RPM are best monitored using low-frequency accelerometers and iT transmitters.



Compressors

Because monitoring of compressors requires both low and high frequency information, using an IEPE sensor coupled to multiple iT series transmitters offers the best protection. Shaft speed, turbo and gear mesh frequencies can all be present in compressors, posing complex monitoring challenges.



Gearboxes

A dynamic sensor with an appropriate transmitter should be used for gearbox monitoring when dynamic signal analysis is anticipated. PC420A series 4-20 mA sensors are the most effective alternative for high frequency components because of their ability to include up to the third harmonic of the gear mesh frequencies in the overall value.

HAZARDOUS AREA 4-20 mA SENSORS

Wilcoxon offers intrinsically safe, explosion-proof, and Class I, Division 2 certified 4-20 mA sensors for use in a variety of hazardous areas. All are certified for use in Class I areas classified as Group A.



Wilcoxon model	PC420A-IS	PC420V-IS	PC420A-EX	PC420V-EX
	Intrinsically safe		Explosion-proof	
Loop output options	RMS, peak	RMS, peak	RMS, peak, true peak	RMS, peak, true peak
Acceleration scaling, g	5, 10, 20, 50	-	5, 10, 20	-
Velocity scaling, ips	-	0.5, 1.0, 2.0, 3.0, 5.0	-	0.5, 1.0, 2.0, 3.0, 5.0
Frequency range	1.0 Hz - 2.0 kHz	3.5 Hz - 2.0 kHz	1.0 Hz - 2.0 kHz	3.5 Hz - 2.0 kHz
Max temperature	105°C	105°C	85°C	85°C
Grounding	case isolated	case isolated	case isolated	case isolated
Mounting	1/4-28 tapped hole	1/4-28 tapped hole	3/8-24 tapped hole	3/8-24 tapped hole
Output connector	2-pin MIL-C-5015	2-pin MIL-C-5015	18 AWG flying leads	18 AWG flying leads
Compliance	CSA, ATEX, IECEx CE	CSA, ATEX, IECEx CE	CSA, ATEX CE	CSA, ATEX CE



Model	North American certification	ATEX certification	IECEx certification
PC420xx-yy-IS PC421xx-yy-IS PC423xx-yy-IS	Class I Div 1 Groups A B C D T3C Ta = 85°C max	II 1 G Ex ia IIC T4 Ga -40° < Tamb < +85°	Ex ia IIC T4 Ga
PC420xx-yy-EX	Class I Div 1, 2 Groups A B C D Class II Div 1, 2 Groups E F G Class III T3C Ta = 85°C max	II 2 G Ex d IIC T3 II 3 G Ex nA IIC T3 -40°C ≤ Ta ≤ +85°C	
PCH420V-R6-HZ, PCH420V-M12-HZ	Class I Div 2 Groups A B C D Class I Zone 2 AEx/Ex nA nC T4 Ta = 105°C max	II 3 G Ex nA nC IIC T4 Gc -40°C < Ta < +105°C	Ex nA nC IIC T4 Gc -40°C < Ta < +105°C

DIGITAL SENSORS WITH HART® PROTOCOL

PCH420V series velocity sensors provide a 4-20 mA output with the added capability of digital communication via HART® 7.0 protocol. The HART functionality allows field configuration of three separate vibration bands, multi-drop installations, and direct connection with existing HART-enabled plant infrastructure.

The sensor can interface with any handheld HART communicator or compatible module via the downloadable Device Description (DD) file and is NAMUR NE43 compliant for plants that require fault identification. Certified -HZ models are available for Class I Div 2 hazardous areas.

PCH420V		
User-configurable	Loop output options	RMS, peak, true peak
	Programmable filter bands	3: PV, SV, TV
	Velocity full-scale, ips	0.5 - 5.0
	Frequency range	3.0 Hz - 1.95 kHz
Max temperature		105°C
Grounding		case isolated
Mounting		1/4-28 tapped hole
Output connector		2-pin MIL-C-5015 (-R6 models) or 4-pin M12 (-M12 models)
Compliance		HART 7.0, NAMUR NE4.3, CE -HZ models: CSA/ATEX/IECEX



Model PCH420V-M12

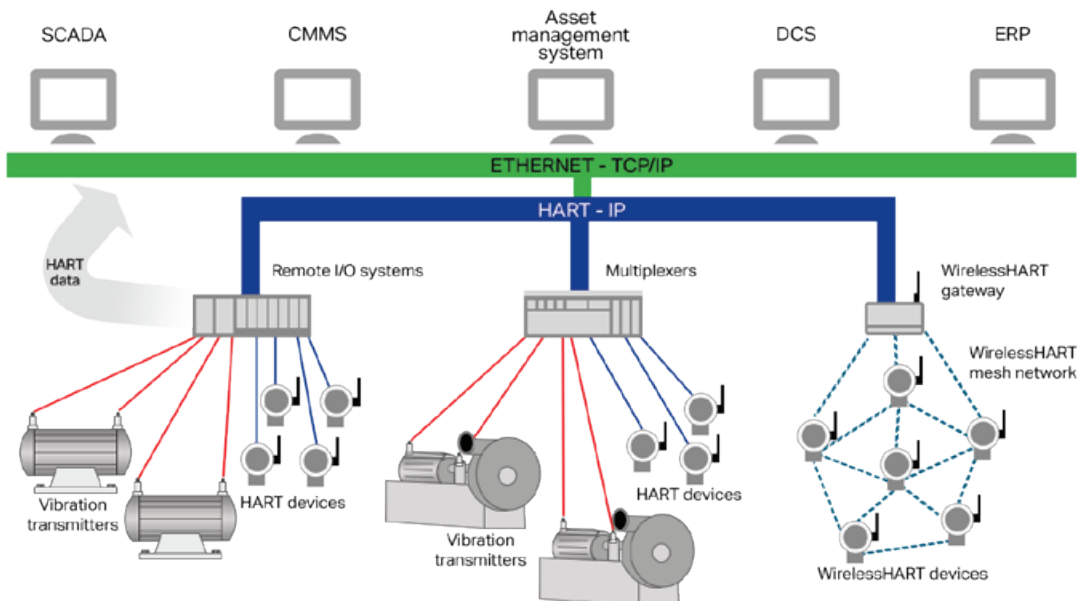

PROCESS CONTROL DISPLAY METERS

PCD100 series

The PCD100 digital panel meters are one of the most versatile on the market, and are used in a wide variety of process and temperature applications. The PCD100 can be field programmed to accept process voltage (0-5V, 1-5V, $\pm 10V$) and current (0-20 mA, 4-20 mA) inputs, 100 Ω RTDs, and the four most common thermocouples.



Features

- » Accepts current (4-20 mA), voltage (0-5V, 1-5V, $\pm 10V$), thermocouple and RTD field-selectable inputs
- » 2 relays, isolated 4-20 mA output options
- » Compatible with PC420 series sensors, iT transmitters
- » Four external contacts for configuration in the field
- » 4-digit display
- » Two alarm points with front panel red LEDs to indicate alarm conditions – useful for applications requiring visual-only indication

One of the PCD100's most useful features is its ability to provide 24 VDC to power the transmitter's 4-20 mA signal. There are two power options: 85 to 265 VAC, or 12-36 VDC. The meter can be programmed via the four external button contacts on the front panel or remotely with the included PC-based software.

Two relays and isolated 4-20 mA output options increase the utility of the PCD100. The relays can be used for alarm or control applications. The 4-20 mA output provides an isolated retransmission of the input signal for temperature inputs.

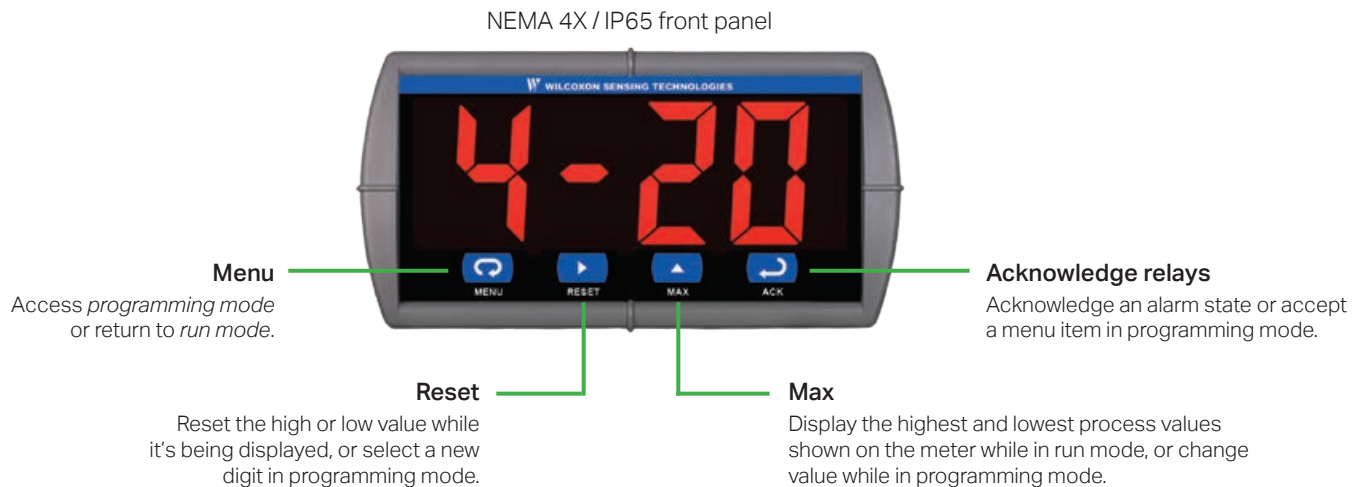

PROCESS CONTROL DISPLAY METERS

PCD200 series

The PCD200 series are 1/8 DIN digital panel meters that accept two inputs of either a process current (4-20 mA) or process voltage (0-5V, 1-5V, $\pm 10V$) signal. It displays these signals on a dual line, 6-digit display that is available with an optional SunBright® sunlight readable LEDs. The meter can be customized such that these two inputs are displayed in a variety of ways, including both at the same time with tags or the result of math functions performed on one or both of the inputs.



All PCD200 models feature a NEMA 4X rated front panel and AC or DC power options. The meter can be equipped with up to four internal relays, a 4-20 mA analog output, and Modbus® serial communications. All PCD200 meters can be programmed via the front panel or remotely using the included PC-based software.

Features

- » Customizable dual-line display
- » Dual inputs with math functions, allowing the meter to quickly display the most relevant variables
- » Accepts 0-20 mA, 4-20 mA, 0-5 V, 1-5 V, and $\pm 10 V$ inputs
- » Compatible with PC420 series sensors, iT transmitters
- » NEMA 4X / IP65 front panel
- » 2 or 4 relays, isolated 4-20 mA output options

Rugged NEMA 4X / IP65 front panel



UV-resistant SunBright sunlight readable models for outdoor applications

INTELLIGENT TRANSMITTERS – 4-20 mA

Wilcoxon's intelligent vibration transmitters measure and process dynamic vibration signals to produce a 4-20 mA output signal. iT modules are a powerful means to connect standard vibration sensors to process control systems.



iT300

The next generation transmitter for your vibration monitoring needs.

- » Easily configurable in the field via internal web server – no stand-alone software needed
- » Two processing bands for optimized frequency ranges, providing more control over fault monitoring and greater flexibility
- » Dual mappable 4-20 mA outputs for access to more information from single sensor input



iT301

All the features of the iT300, plus:

- » Modbus/RS-485 enabled, allowing multiple communication methods to plant infrastructure
- » Configurable high/low alarms for better control over fault monitoring
- » Low and high alarms are mappable to a single NC/NO relay

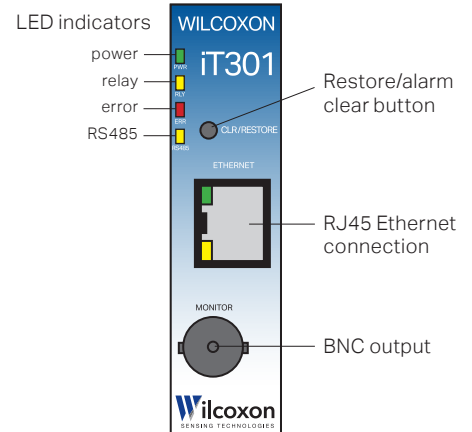

How iT works

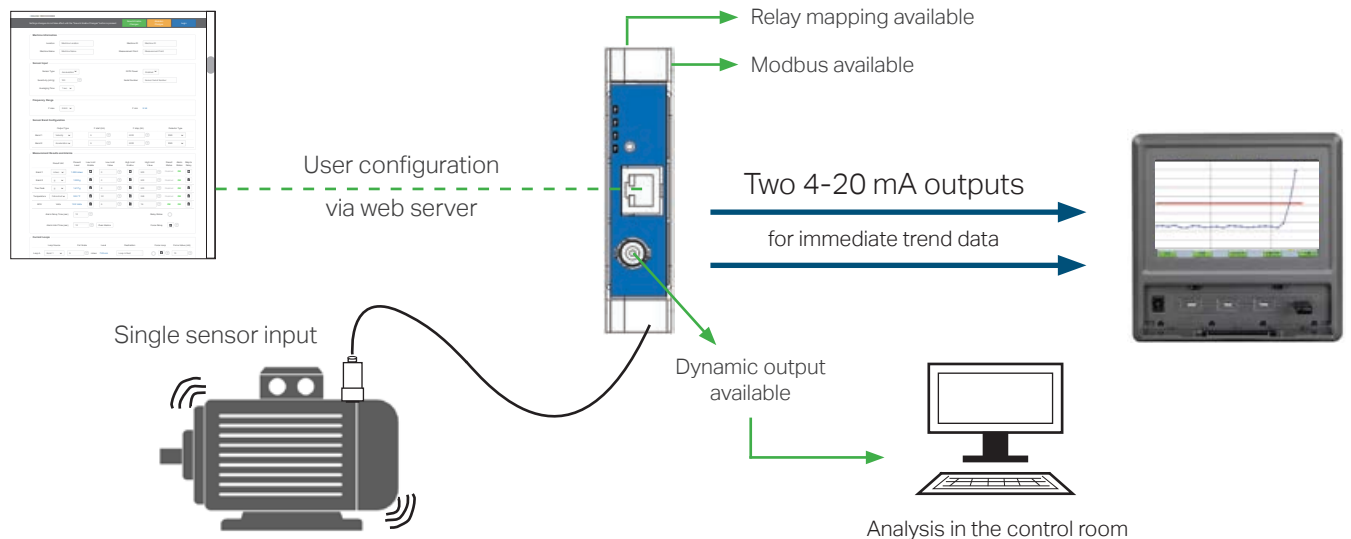

TRANSMITTERS & ALARMS

iT150

New cost-effective transmitter with easy plug-and-play capability.

- » Multiple pre-configured units to choose from, tailored to the most common applications
- » Compatible with dual-output sensors to measure both vibration and temperature
- » True peak detection band measures acceleration signals out to 25 kHz



iT series comparison

Feature	iT150	iT300	iT301
DIN-rail mountable	X	X	X
Accepts accelerometers, dual-output (vibration + temperature), velocity sensors	X	X	X
20V peak-peak sensor input	X	X	X
Primary and secondary 4-20mA outputs	X	X	X
0.2 Hz - 20 kHz bandwidth	X	X	X
24-bit A/D converter	X	X	X
User configuration via web page		X	X
Field-configurable full-scale range		X	X
Field-configurable vibration bands (2X)		X	X
Modbus TCP/RS-485			X
High and low alarm limits			X
Relay/alarm source mapping			X

iT401 alarm module

The iT401 compares 4-20 mA input against configurable alarm limits to provide local notification of potential problems.

- » Accepts input from iT transmitter or any 4-20 mA sensor
- » Three field-programmable relays: high or low setpoints with time delay
- » Front panel LED readout and push button softkeys
- » Programmable time and hysteresis delay prevent false alarms



Wilcoxon offers enclosures (single and dual DIN rail) to hold up to 25 iT modules and power supplies.

iT300/iT301 USER CONFIGURATION

The internal web server built into iT300 and iT301 modules eliminates the need for separate software or even an internet connection, making it easy to configure in the field. It's designed to allow users to enter unique machine information and sensor specifications, and adjust frequency range, filter bands, output types, and current loops according to the needs of the application.

Frequency Range

F max F min

Sensor Band Configuration

	Output Type	F start (Hz)	F stop (Hz)	Detector Type
Band 1	<input type="text" value="Velocity"/>	<input type="text" value="5"/>	<input type="text" value="5000"/>	<input type="text" value="RMS"/>
Band 2	<input type="text" value="Acceleration"/>	<input type="text" value="5"/>	<input type="text" value="5000"/>	<input type="text" value="RMS"/>

Current Loops

	Loop Source	Full Scale	Level	Destination	Force Loop	Force Value (mA)
Loop A	<input type="text" value="Band 1"/>	<input type="text" value="5"/>	in/sec <input type="text" value="7.20 mA"/>	<input type="text" value="Loop A Dest"/>	<input type="radio"/> <input type="checkbox"/>	<input type="text" value="10"/>
Loop B	<input type="text" value="Disabled"/>	<input type="text" value="5"/>	<input type="text" value="0.00 mA"/>	<input type="text" value="Loop B Dest"/>	<input type="radio"/> <input type="checkbox"/>	<input type="text" value="10"/>

On iT301 modules, measurement results and alarm limits can be adjusted to individual requirements.

Measurement Results and Alarms

	Result Unit	Present Level	Low Limit Enable	Low Limit Value	High Limit Enable	High Limit Value	Result Status	Alarm Status	Map to Relay
Band 1	<input type="text" value="in/sec"/>	<input type="text" value="1.000 in/sec"/>	<input type="checkbox"/>	<input type="text" value="0"/>	<input type="checkbox"/>	<input type="text" value="500"/>	Disabled	OK	<input type="checkbox"/>
Band 2	<input type="text" value="g"/>	<input type="text" value="1.000 g"/>	<input type="checkbox"/>	<input type="text" value="0"/>	<input type="checkbox"/>	<input type="text" value="500"/>	Disabled	OK	<input type="checkbox"/>
True Peak	<input type="text" value="g"/>	<input type="text" value="1.417 g"/>	<input type="checkbox"/>	<input type="text" value="0"/>	<input type="checkbox"/>	<input type="text" value="500"/>	Disabled	OK	<input type="checkbox"/>
Temperature	<input type="text" value="Fahrenheit"/>	<input type="text" value="32.0 °F"/>	<input type="checkbox"/>	<input type="text" value="32"/>	<input type="checkbox"/>	<input type="text" value="248"/>	Disabled	OK	<input type="checkbox"/>
BOV	Volts	<input type="text" value="12.0 Volts"/>	<input checked="" type="checkbox"/>	<input type="text" value="5"/>	<input checked="" type="checkbox"/>	<input type="text" value="16"/>	OK	OK	<input type="checkbox"/>

Alarm Delay Time (sec) Relay Status

Alarm Hold Time (sec) Force Relay

SENSOR SELECTION CHART

Wilcoxon model	Sensitivity	Sensitivity tolerance	Frequency response, ± 3 dB		Exit type / connector	Max temp °C	Mounting thread	psd noise @ 100 Hz	Acceleration range	Weight	Haz. area option
			Hz	kHz				/Hz	peak	grams	
High performance											
780A	100 mV/g	$\pm 5\%$	0.5 - 14k	30	top, R6	120	1/4-28	5 μ g	80 g	62	Y
786A	100 mV/g	$\pm 5\%$	0.5 - 14k	30	top, R6	120	1/4-28	5 μ g	80 g	90	Y
786LF	100 mV/g	$\pm 5\%$	0.1 - 13k	30	top, R6	120	1/4-28	3 μ g	50 g	90	
787A	100 mV/g	$\pm 5\%$	0.5 - 10k	22	side, R6	120	1/4-28	5 μ g	80 g	145	Y
General purpose											
780B	100 mV/g	$\pm 10\%$	0.5 - 14k	30	top, R6	120	1/4-28	5 μ g	80 g	62	
780C	100 mV/g	$\pm 15\%$	0.5 - 14k	30	top, R6	120	1/4-28	5 μ g	80 g	62	
785A	100 mV/g	$\pm 10\%$	1.0 - 12k	30	side, R6	120	1/4-28	6 μ g	80 g	85	
786B-10	100 mV/g	$\pm 10\%$	0.5 - 14k	30	top, R6	120	1/4-28	5 μ g	80 g	90	
787B	100 mV/g	$\pm 10\%$	0.5 - 10k	22	side, R6	120	1/4-28	5 μ g	80 g	145	
Extended temperature range											
HT780A	100 mV/g	$\pm 5\%$	0.5 - 14k	30	top, R6	150	1/4-28	5 μ g	80 g	62	
HT786A	100 mV/g	$\pm 5\%$	0.5 - 14k	30	top, R6	150	1/4-28	5 μ g	80 g	90	
HT787A	100 mV/g	$\pm 5\%$	0.5 - 10k	22	side, R6	150	1/4-28	5 μ g	80 g	145	
376/CC701HT	100 mV/g	$\pm 10\%$	1.0 - 15k	30	top, R1 / inline, R2	260 / 100	1/4-28	broadband: 0.001 g	50 g	75/40	
High sensitivity / low frequency											
786-500	500 mV/g	$\pm 5\%$	0.2 - 14k	30	top, R6	120	1/4-28	1.5 μ g	10 g	90	Y
786LF-500	500 mV/g	$\pm 5\%$	0.1 - 13k	30	top, R6	120	1/4-28	2 μ g	10 g	90	
787-500	500 mV/g	$\pm 5\%$	0.2 - 10k	22	side, R6	120	1/4-28	1.5 μ g	10 g	145	Y
793L	500 mV/g	$\pm 5\%$	0.2 - 2.3k	15	top, R6	120	1/4-28	0.2 μ g	10 g	142	Y
797L	500 mV/g	$\pm 5\%$	0.2 - 3.7k	18	side, R6	120	1/4-28	0.2 μ g	10 g	148	Y
799LF	500 mV/g	$\pm 5\%$	0.1 - 2.5k	18	top, R6	120	1/4-28	1 μ g	10 g	205	
Integral cable											
786F	100 mV/g	$\pm 5\%$	0.5 - 13k	30	top, integral cable	120	1/4-28	5 μ g	80 g	90	Y
787F	100 mV/g	$\pm 5\%$	0.5 - 10k	22	side, integral cable	120	1/4-28	5 μ g	80 g	145	
712F	100 mV/g	$\pm 10\%$	3.0 - 25k	>45	side, integral cable	120	8-32	10 μ g	60 g	35	
780FM-2-J88C	100 mV/g	$\pm 15\%$	0.4 - 12k	30	top, integral cable	120	1/4-28	4 μ g	80 g	150.5	
High g sensors											
786A-I	10 mV/g	$\pm 5\%$	0.5 - 14k	30	top, R6	120	1/4-28	23 μ g	500 g	90	
732A/732AT	10 mV/g	$\pm 5\%$	0.5 - 25k	60	side/top, R1	120	10-32	3 μ g	500 g	13	
793-10	10 mV/g	$\pm 5\%$	1.0 - 15k	25	top, R6	120	1/4-28	40 μ g	500 g	110	Y
997	10 mV/g	$\pm 10\%$	0.5 - 29k	>45	side, integral cable	120	8-32 or M4	9 μ g	600 g	35	
Specialty sensors											
HV100/200	100 mV/g	$\pm 5\%$	0.5 - 12k	25	top, R6 or M12	120	1/4-28, M6 or M8	5 μ g	80 g	122 or 126	
HV100/200LF	100 mV/g	$\pm 5\%$	0.1 - 11k	28	top, R6 or M12	120		5 μ g	80 g		
HV100/200LF-500	500 mV/g	$\pm 5\%$	0.1 - 11k	28	top, R6 or M12	120		2 μ g	10 g		
732-1D	10 mV/g	$\pm 5\%$	0.4 - 22k	28	top, BNC	120	10-32	4 μ g	500 g	28	
LPA100T	50 mV/g	$\pm 5\%$	0.3 - 15k	30	top, M12	120	1/4-28	16 μ g	25 g	90	Y
793R	100 mV/g	$\pm 5\%$	1.0 - 15k	26	top, R6	120	1/4-28	5 μ g	80 g	110	
797R	100 mV/g	$\pm 5\%$	1.0 - 15k	26	side, R6	120	1/4-28	5 μ g	50 g	135	

Wilcoxon model	Sensitivity	Sensitivity tolerance, ±	Frequency response, ±3 dB	Resonance	Exit type / connector	Max temp	Mounting thread	psd noise @ 100 Hz	Acceleration range	Weight grams	Haz. area option
			Hz	kHz		°C		/√Hz	peak		
Seismic											
731A	10 V/g	±10%	0.05 - 450	0.75	top, R6	65	3/8-16	0.004 µg	0.5 g	760	
731A/P31	10-1,000 V/g	±10%	0.05 - 450	0.75	BNC	65	3/8-16	0.004 µg	0.5 g	760/600	
735T	10 V/g	±10%	0.01 - 350	0.7	top, M12	65	M6x1	0.0035 µg	0.5 g	380	
731-207	10 V/g	±10%	0.2 - 1.3k	2.4	top, R1	80	10-32	0.03 µg	0.5 g	60	
799M	1 V/g	±5%	0.2 - 2.5k	18	top, R6	80	1/4-28	1 µg	5 g	205	
Dual output (vibration + temperature)											
786T	100 mV/g	±5%	0.5 - 12k	30	top, R6G	120	1/4-28	5 µg	80 g	90	Y
787T	100 mV/g	±5%	0.5 - 12k	22	side, R6G	120	1/4-28	5 µg	80 g	145	
793T-3	100 mV/g	±5%	0.5 - 15k	24	top, R6G	120	1/4-28	5 µg	80 g	115	
797T-1	100 mV/g	±5%	1.0 - 12k	26	side, R6G	120	1/4-28	5 µg	80 g	135	
797LT	500 mV/g	±5%	0.2 - 3.7k	18	side, R6G	120	1/4-28	0.2 µg	10 g	160	
Piezovelocity transducers											
793V	100 mV/ips	±10%	2.5 - 7k	15	top, R6	120	1/4-28	1.0 µin/sec	50 in/sec	145	Y
793V-5	500 mV/ips	±10%	5.0 - 7k	15	top, R6	120	1/4-28	0.4 µin/sec	10 in/sec	145	
793V100-5	100 mV/ips	±5%	2.5 - 7k	15	top, R6	120	1/4-28	1.0 µin/sec	50 in/sec	145	
793VR	100 mV/ips	±10%	2.0 - 7k	15	top, R6	120	1/4-28	1.0 µin/sec	50 in/sec	133	
797V	100 mV/ips	±10%	1.6 - 7k	18	side, R6	120	1/4-28	0.8 µin/sec	50 in/sec	148	Y
893V	100 mV/ips	±5%	4.5 - 5k	15	top, R6	120	1/4-28	1.5 µin/sec	50 in/sec	145	
Triaxial											
993B series (-5, -6, -7)	25, 50, or 100 mV/g	±10%	Z: 2 - 10k X, Y: 2 - 7k	>35	top, integral cable	120	10-32	3.2, 2.0, or 1.4 µg	160, 80 or 40 g	134	Y
993B-7-M12	100 mV/g	±10%	Z: 2 - 10k X, Y: 2 - 7k	>35	top, M12	120	10-32	2 µg	60 g	124	Y
Traditional											
793	100 mV/g	±5%	0.5 - 15k	25	top, R6	120	1/4-28	5 µg	80 g	112	Y
797	100 mV/g	±5%	1.0 - 12k	26	side, R6	120	1/4-28	5 µg	80 g	138	Y
793-6	100 mV/g	±10%	1.0 - 12k	25	top, R6	150	1/4-28	10 µg	50 g	135	
797-6	100 mV/g	±10%	1.0 - 11k	18.5	side, R6	150	1/4-28	10 µg	50 g	145	
Underwater accelerometers											
746	100 mV/g	±5%	1.0 - 15k	30	top, integral cable	80	10-32	0.8 µg	80 g	45	

4-20 mA output vibration sensors											
Wilcoxon model	Measurement	Loop output options	Full scale, 20 mA	Tolerance	Frequency response, ±3 dB (Hz)	Exit type / connector	Max temp (°C)	Mounting thread	Weight (grams)	Haz. area option	
PC420A	Acceleration	RMS, peak, true peak	5, 10, 20, 50 g	±5%	1.0 - 2k	top, R6	105°C	1/4-28	162	Y	
PC420V	Velocity	RMS, peak	0.5, 1.0, 2.0, 3.0, 5.0 ips	±5%	1.0 - 2k	top, R6	105°C	1/4-28	162	Y	
PC420DPP-40	Displacement	peak-to-peak	40 mils	±5%	10 - 1k	top, R6	85°C	1/4-28	162		
PC420A-EX	Acceleration	RMS, peak, true peak	5, 10, 20, 50 g	±5%	4.0 - 2k	flying leads	85°C	3/8-24	380	Y	
PC420V-EX	Velocity	RMS, peak	0.5, 1.0, 2.0, 3.0, 5.0 ips	±5%	4.0 - 2k	flying leads	85°C	3/8-24	380	Y	
PCC421A	Acceleration	RMS, peak	5, 10, 20, 50 g	±5%	4.0 - 2k	side, R6	105°C	1/4-28	140		
PCC421V	Velocity	RMS, peak	0.5, 1.0, 2.0, 3.0, 5.0 ips	±5%	4.0 - 2k	side, R6	105°C	1/4-28	140		
PCH420V	Velocity	RMS, peak, true peak	0.5 - 5.0 ips	±5%	3.0 - 1.95k	top, M12	105°C	1/4-28	115	Y	

SERVICE & SUPPORT

As an industry leader in vibration measurement technology, Wilcoxon offers decades of expertise. You can rely on our knowledgeable team for efficient and friendly service and support. We aim to be helpful to our customers every step of the way. Our services include:

- » Technical support and field application support
- » Calibration
- » Responsive customer service
- » Product modification
- » Repairs
- » Custom-designed products



MANUFACTURING & OPERATIONS

Wilcoxon is at the forefront of growth and technological development. To support our customers while maintaining the high degree of quality and reliability that Wilcoxon is known for, in October 2018 we moved to a new, larger facility in Frederick, Maryland.



Our new building capacity is a significant driver for implementing technical advantages, including a variety of modern manufacturing, assembly, and test equipment ranging from precision machinery to produce our high quality vibration sensors to custom-built machinery designed to enhance production capabilities. We are leveraging our expanded space to build products across our entire line and support the needs of our customers.

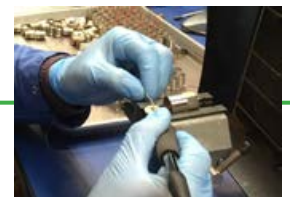

RESOURCES

When you need useful information on vibration monitoring, Wilcoxon is a trusted source for answers. Whether you're new to the field or have years of experience, be sure to take advantage of our online resource library for practical insight and guidance. Our online resources are accessible 24/7 at wilcoxon.com/resources, and available for download.

From best practices and how-to guides, to specific insight on sensor selection, mounting considerations and much more, Wilcoxon's free online resources include:

- » Application notes
- » Case studies
- » FAQ and blog
- » Technical notes
- » White papers
- » Operating guides
- » User manuals
- » Product information including data sheets and specifications

Whatever your industry or application, we have the solutions you need for vibration monitoring. Our online resources are conveniently available 24/7. Go to wilcoxon.com and buy.wilcoxon.com to get started.

Authorised distributor

Order Placement:

For customer service, call 1300-735-292
To fax an order, use 1800-067-639
To email an order, ordersau@thermofisher.com

Contact Us:

For customer service, call 1300-735-292
For service and calibration, call 1300-736-767
To order online: thermofisher.com.au

ThermoFisher
SCIENTIFIC

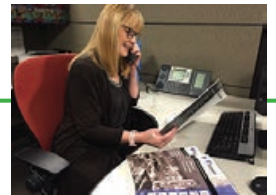

Industries served

Aerospace
Automotive
Cement
Chemical processing
Condition monitoring
Defense
Food and beverage
Machine tool
Marine
Metals processing
Mining
Nuclear
Oil and gas
Pharmaceutical
Power generation
Pulp and paper
Rail
Seismic
Water and wastewater
Wind power