

Portavo

The first portables with Memosens technology for measuring pH, ORP, conductivity, and oxygen.





The future is now.

Introducing Portavo from Knick, the first mobile analyzers for pH, ORP, conductivity, and oxygen with digital Memosens technology.



Functionality

Analog and optical oxygen sensors can also be used in addition to digital Memosens sensors. The transreflective color display can be read easily, even in direct sunlight.

Flexible Extension Options

- Custom pH calibration with new Cal SOP calibration procedure
- Security package with access control for improved security during operation
- Multi-channel function for simultaneous operation of 2 sensors

Communication

The data logger can record up to 10,000 values. Data logger entries can be shown on the display using an extensive recorder function. The standard micro USB port enables

- connection to a PC
- software updates
- charging of the Li-ion rechargeable battery

Design

Ergonomically optimized for on-site and laboratory use. The sturdy and chemical-resistant housing provides a number of smart features: The integrated yet removable quiver protects the sensor. The multi-functional hook together with the reversible protective cover ensures freedom of movement by allowing the devices to be hung up or positioned upright.

Ex Versions

The world's only portable Memosens analyzer for use in hazardous locations. Ideal for applications in the process industry in Zone 0/1 and Cl1, Div 1.



Portavo

Benefits at a Glance:

- Portable multiparameter analyzer for Memosens sensors
- Also suitable for analog sensors
- Multiparameter versions for pH, ORP, conductivity, and oxygen
- Multi-channel operation with any 2 sensors
- Multi-functional housing for process and laboratory
- Integrated protective cover, also acts as benchtop stand
- Integrated hook for positioning upright or hanging up
- Integrated sensor quiver, protects the sensor from drying out
- Indestructible 1 m drop height onto concrete
- Mineral glass screen can still be read perfectly after many years

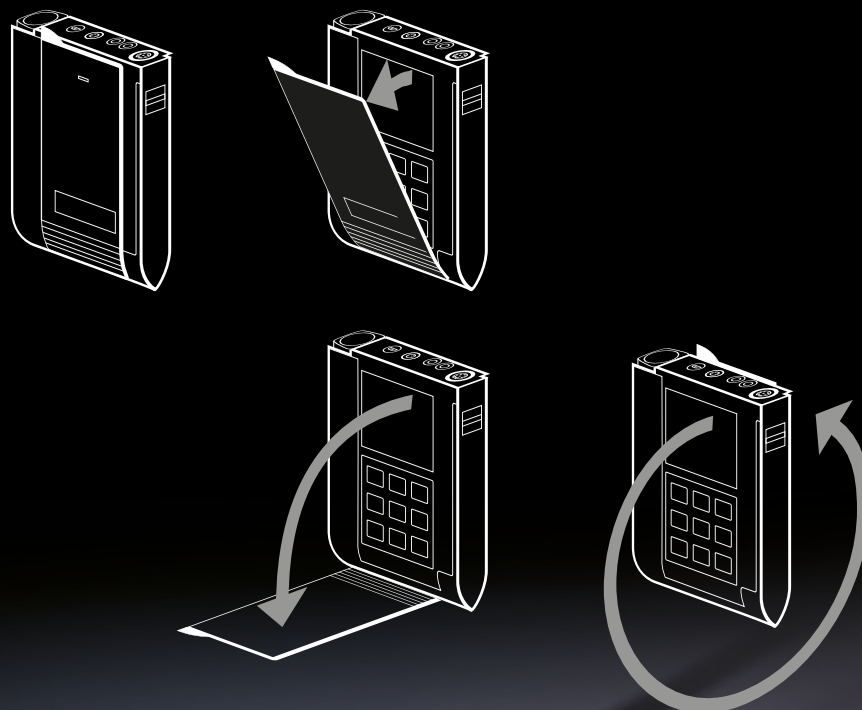

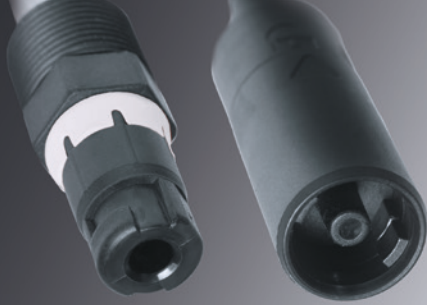

Reliability has a name.



Memosens. The contactless plug-in system transfers both energy and data between sensors and Portavo.

Contactless System

Only Memosens is unaffected by dirt or moisture. Even if the system is put together under water.

Smart Diagnostics

Smart integrated diagnostic functions guarantee optimum process management.

Availability is increased by monitoring the sensor operating time, sensor wear, remaining lifetime, maximum temperature, adaptive calibration timer, and calibration and adjustment data.



Benefits at a Glance:

- Plug & Measure
Sensor replacement in seconds with pre-calibrated sensors
- Just one cable for all sensors
- Simple and safe connection with bayonet coupling
- Contactless, digital data transfer
- All key data available in the sensor
- Reliable measurements, even in the toughest conditions
- Multiparameter operation



Portavo

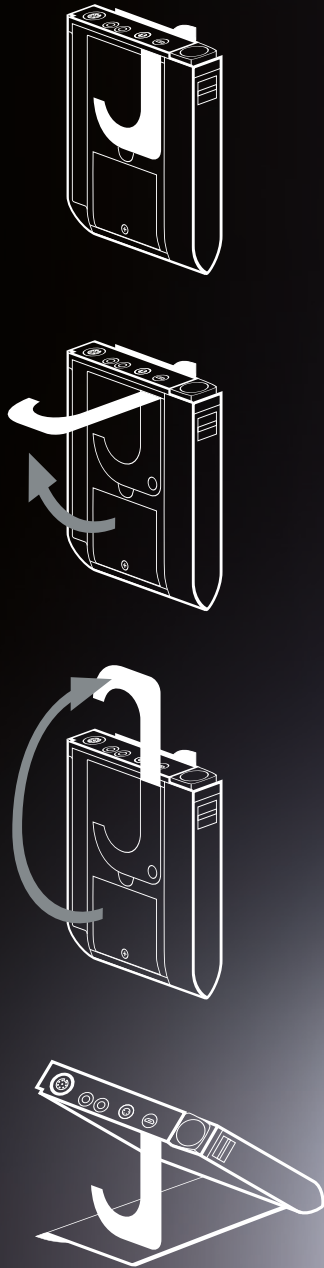

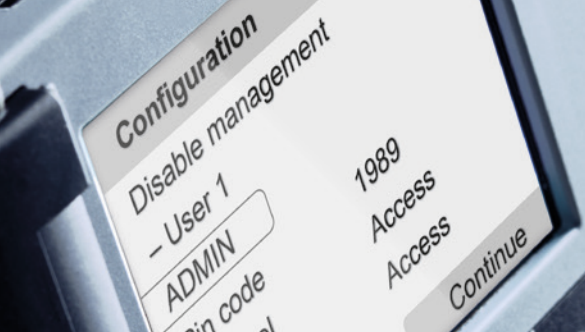

Portable Multiparameter Analyzer



Portavo 908 Multi. Portable Memosens-based measuring device for the analysis of liquids with direct printer control.

Many features distinguish the Portavo 908 Multi for use in the pharmaceutical and biotech field. These include

- new pH calibration procedure with a set process flow
- multi-level user management with access control
- direct assignment of Memosens sensors to device, for increased safety during operation

Multi-Channel Function for Simultaneous Operation of 2 Sensors

If equipped with the multi-channel option, Portavo 908 Multi can be used for simultaneous measurements using 2 flexibly combined sensors. The multi-channel function is added to the functionality of the data logger.

Great Flexibility Thanks to Multiparameter Technology

Portavo 908 Multi enables versatile and flexible use. As soon as the sensor is connected, the Portavo 908 Multi automatically adjusts to the selected

parameter. All relevant sensor data can be seen at a glance.

GLP Compliant

The USB port allows the Portavo to be connected to a local printer. The sensor calibration record can be printed directly. It contains

- Date and time stamp
- Device Information
- Sensor Information
- Calibration data

Complete documentation of calibration and test data guarantees that SOP guidelines are met.

Portavo 908 Multi fulfills the GLP documentation requirement and thus improves quality management according to ISO 9001.

An Inspection Certificate 3.1 according to EN 10204 rounds out the package.

Calibration Record Date	26.11.2015	11:41
Device Information	Knick	
Manufacturer	0003792	
Serial No.	908 Multi	
Type	1.5.0.Build 10904	
SW Version		
Sensor Information	Memosens	
Sensor Type	pH	
Manufacturer	Knick	
Order No.	SE 555X/1-NMSN	
Serial No.	2180694	
Software Ver.	1.0.6	
Hardware Ver.	1.5.2	
TAG	ABC 13.11.12_wo	
Temp. Offset	0.0 K	
Operating Time	50 h	
Wear	0 %	
SIP	0	
Calibration data		
Calibration Date	14.06.15	14:48
Zero Point	pH 7.201	11.8 mV
Slope	99.154 %	58.7 mV
Buffer 1	pH 4.005	
Buffer 2	pH 6.996	

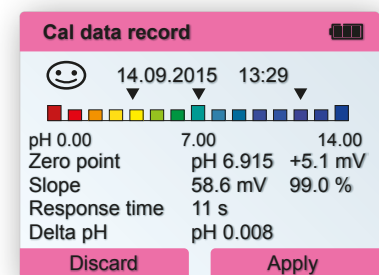
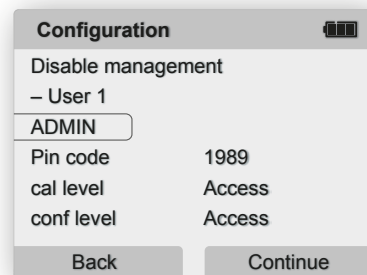

Portavo 908 Multi



Custom pH Calibration

The new Cal SOP calibration procedure allows pH sensors to be checked with up to 3 calibration points. A buffer is used as the verification buffer. The buffer set for each calibration point can be separately selected, thus also allowing their order to be determined.

Temperature Calibration

Temperature probe adjustment in the Memosens sensor (offset correction)

Security Package Included

The Portavo 908 Multi's professional user management regulates access to the device and the sensor.

- Increased security for configuration, calibration, and measurement data
- No unauthorized interventions during the operating cycle
- Up to 4 user profiles can be set
- Different access rights can be established

Greater Reliability During Operation

Memosens sensors can be assigned directly to the Portavo 908 Multi using the data stored in the sensor, such as

- Sensor type
- TAG
- Group

Unambiguous assignment of the sensor to the device reduces the potential for errors.



The Flagship.



Portavo 907 Multi. The flagship in the Portavo product line with multiparameter functionality and a high-resolution color display.

Portable multiparameter analyzer for all Memosens parameters. Also for conventional analog sensors. The powerful Li-ion rechargeable battery can be charged via USB in the device. The clear sensor diagram provides an at-a-glance view of the sensor condition.

Comprehensive Data Logger

The following logger types can be selected:

- Manual logging
- Time-controlled logging at set intervals
- Signal-controlled logging of process variables and temperatures
- Combined time- and signal-controlled logging
- Threshold-controlled logging with pre-trigger

The data logger for up to 10,000 entries records measuring point, annotation, sensor ID, sensor serial number (Memosens), primary value, temperature, time stamp, and device status.

User-Friendly Software

Portavo 907 proves that high functionality and ease of use do not exclude one another. It guides you step by step through the calibration procedure. Technical terms are clearly explained in the context help.

Multi-Channel Function for Simultaneous Operation of 2 Sensors

If equipped with the multi-channel option, Portavo 907 can be used for simultaneous measurements using 2 flexibly combined sensors. The multi-channel function is added to the functionality of the data logger.

Custom pH Calibration

The new Cal SOP calibration procedure allows pH sensors to be checked with up to 3 calibration points. A buffer is used as the verification buffer. The buffer set for each calibration point can be separately selected, thus also allowing their order to be determined.

Commercial or user-specific buffer solutions can be used. A maximum permissible deviation (Delta pH) is entered for the verification buffer.

Security Package, Including User Management

The Portavo 907 Multi's professional user management regulates access to the device and the sensor.

- Increased security for configuration, calibration, and measurement data
- No unauthorized interventions during the operating cycle
- Up to 4 user profiles can be set
- Different access rights can be established

Depending on the user's experience, the role profile can optionally be defined for configuration of the

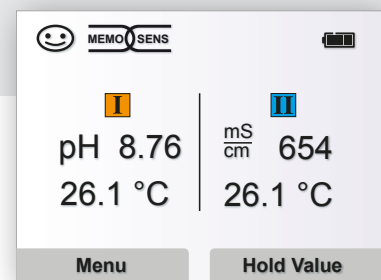

device and sensor or for sensor calibration. This clearly minimizes the risk of inadvertently changing settings.

Temperature Calibration

Temperature probe adjustment in the Memosens sensor (offset correction)

Portavo 907 Multi



Digital



pH



Cond



Condl



Oxy

Analog



pH



Cond



Greater Reliability During Operation

Memosens sensors can be assigned directly to the Portavo 907 Multi using the data stored in the sensor, such as

- Sensor Type
- TAG
- Group

Unambiguous assignment of the sensor to the device reduces the potential for errors. This ensures that only the right sensors are used for the selected measuring point.

Portavo 907 Multi pH

Multiparameter portable device for

the following Memosens sensors.

pH, ORP, conductivity, oxygen
In addition: analog pH sensors with DIN connector

Portavo 907 Multi Cond

Multiparameter portable device for the following Memosens sensors.
pH, ORP, conductivity, oxygen
In addition: SE 202 and SE 204 analog conductivity sensors

Portavo 907 Multi Oxy

Multiparameter portable device for the following Memosens sensors.
pH, ORP, conductivity, oxygen
In addition: digital SE 340 optical oxygen sensor

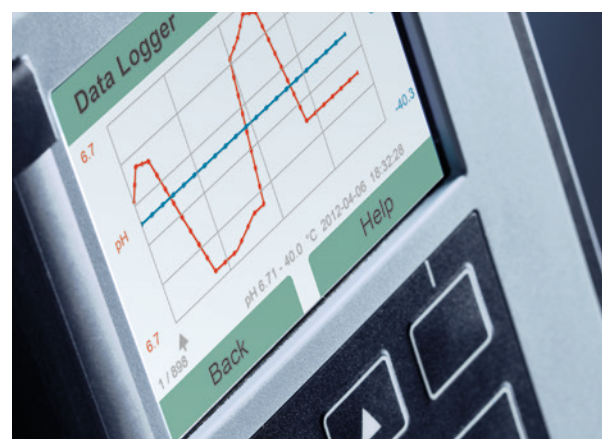



Unique.



Portavo 904 X. The world's only portable multi-parameter analyzer for liquid analysis in hazardous locations up to Zone 0/1.

Ideal for applications in the process industry.



Portavo 904 X Multi

Multiparameter analyzer for pH, ORP, oxygen, and conductivity with Memosens sensors.

Portavo 904 X pH

Portable analyzer for pH measurement using Memosens sensors and DIN pH sensors.

Portavo 904 X Cond

Portable analyzer for measurement using Memosens sensors and analog conductivity sensors.

For the first time, Portavo makes it possible to check process measuring points directly on site. It is suitable for all Memosens pH, ORP, conductivity and amperometric oxygen sensors and, if required, also for analog pH or conductivity sensors.

The MemoLog function allows the user to save calibration data from various Memosens measuring points directly in the device. They can then be easily transferred to a PC via the USB port. The Paraly SW 112 software enables easy management of all recorded data.

Custom pH Calibration

The Cal SOP calibration procedure allows pH sensors to be checked with up to 3 calibration points. A buffer is used as the verification buffer.

The buffer set for each calibration point can be separately selected, thus also allowing their order to be determined.

Custom buffer solutions can be used, or choose from a list of commercially available buffer sets, e.g., CaliMat, NIST, and DIN. A maximum permissible deviation (Delta pH) is entered for the verification buffer.

Security Package Including User Management

The Portavo 904's professional user management regulates access to the device and the sensor.

- Increased security for configuration, calibration, and measurement data
- No unauthorized interventions during the operating cycle
- Up to 4 user profiles can be set
- Different access rights can be established

Depending on the user's experience, the role profile can optionally be defined for configuration of the device and sensor or for sensor calibration. This clearly minimizes the risk of inadvertently changing settings.

Temperature Calibration

Temperature probe adjustment in the Memosens sensor (offset correction)

Greater Reliability During Operation

Memosens sensors can be assigned directly to the Portavo 904 using the data stored in the sensor, such as

- Sensor type
- TAG
- Group

Unambiguous assignment of the sensor to the device reduces the potential for errors. This ensures that only the right sensors are used for the selected measuring point.

Portavo 904 (X)

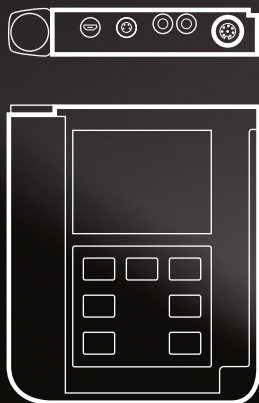

Portavo 904.
 Portable device with
 high-contrast segment
 display.

Up to 5,000 values can be recorded using the integrated data logger. Using the USB port and Paraly SW112 software, the logger data can be easily transferred to a PC for evaluation.

Portavo 904 pH

Portable analyzer for pH measurement using Memosens sensors and DIN pH sensors.

Portavo 904 Cond

Portable analyzer for measurement using Memosens sensors and analog conductivity sensors.

Portavo 904 Oxy

Portable analyzer for measuring dissolved oxygen using amperometric Memosens oxygen sensors.



The Basis

Portavo 902. The basic version for measuring pH, ORP, or conductivity.



Smart

Ergonomically optimized for on-site and laboratory use.

The integrated yet removable quiver protects the sensor. The multi-functional hook together with the reversible protective cover ensures freedom of movement by allowing the devices to be hung up or positioned upright.

Robust

The robust and chemically resistant housing with IP66/67 is also suitable for outdoor use. The high-contrast LC display with scratch-proof mineral glass screen can still be read perfectly after many years.

Temperature Calibration

Temperature probe adjustment in the Memosens sensor (offset correction)

Facts and Features

- A sensor quiver protects the sensor from drying out or being damaged in daily use.
- The sturdy housing with IP66/67 protection is also suitable for outdoor use.
- Memosens and analog sensors can be used with the same device
- Mineral glass screen can still be read perfectly after many years
- Temperature calibration. Temperature probe adjustment in the Memosens sensor (offset correction)



Portavo 902



Portavo 902 pH

Portable pH meter for digital Memosens sensors or analog DIN pH sensors.

Portavo 902 Cond

Portable conductivity meter for connection to Memosens or analog sensors.



The Portavo Product Line.



Device

Sensors

Connections/software

Calibration

Data storage

Ex approval

Cal SOP
calibration method
Temperature calibration

Overview



	902	904	904 X	907	908
High-resolution, daylight-readable TFT color display				•	•
High-contrast static segment display	•	•	•		
Open, easy-to-clean quiver	•	•	•	•	•
Carrying strap	•	•	•	•	•
Real-time clock	•	•	•	•	•
Li-ion rechargeable battery, replaceable and chargeable via USB		•		•	•
MemoLog logger for Memosens calibration and sensor data		•	•	•	•
Multilingual				•	•
Multiparameter for pH, ORP, conductivity, oxygen			•	•	•
Multi-channel function: Simultaneous measurement with any 2 sensors				•	•
SE 340 optical oxygen sensor				•	•
Analog pH sensors with DIN connector	•	•	•	•	
Analog conductivity sensors	•	•	•	•	
Memosens sensors	•	•	•	•	•
USB port for connecting a printer					•
Paraly SW 112 software for communication with PC		•	•	•	•
Calibration with automatic buffer recognition (Calimatic)	•	•	•	•	•
Calibration by data entry	•	•	•	•	•
Manual calibration by free specification of buffer values	•	•	•	•	•
Calibration timer, can be switched off	•	•	•	•	•
Data logger for automatic recording of measured values		•	•	•	•
Measured value logger (number of values)		5,000	5,000	10,000	10,000
Ex Zone 0/1			•		
User management, sensor verification, temperature probe adjustment in the Memosens sensor (offset correction) SW-P001		•	•	•	•
Temperature probe adjustment in the Memosens sensor (offset correction) SW-P002	•	•	•	•	•

Everything else you want to know about interference-free
pH, ORP, conductivity, and oxygen measurement ...

Knick >



Interface Technology

Indicators

Process Analytics

Portables

Laboratory Meters

Sensors

Fittings

... is available from the Knick Memosens Academy.
With clear practical examples and suggested solutions.
Now. Free. Online.

www.memosens-academy.com



Authorised distributor

In Australia:

For customer service, call 1300-735-292
To email an order, ordersau@thermofisher.com
To order online: thermofisher.com

In New Zealand:

For customer service, call 0800-933-966
To email an order, ordersnz@thermofisher.com
To order online: thermofisher.com

ThermoFisher
SCIENTIFIC