



KONICA MINOLTA

LIGHT METERS

ILLUMINANCE METER

LUMINANCE METER

CHROMA METER

36



T-10A / T-10MA/ T-10WsA/T-10WLA

CL-200A

CL-500A

CL-70F

LS-150/160

CS-150/160

CS-200

Illuminance Meter T-10A series

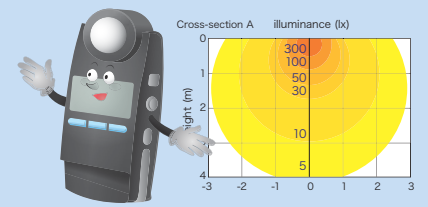

Compatible with new, next-generation light sources including PWM-controlled sources. For simple but accurate illuminance measurements. Makes creating illuminance measurement systems such as multi-point measurement systems easy!

<Standard receptor>

T-10A



Receptor diffuser window: Ø 25 mm

<Mini receptor >

T-10MA/T-10W_sA/T-10W_LA



Receptor diffuser window: Ø 14 mm

T-10A

Conforms to JIS AA Class and DIN class B

Can be used for general measurements of illuminance.

T-10MA (Cord length: 1 m)

Conforms to JIS AA Class and DIN class B

Enables illuminance measurements of small areas.

Can be used for illuminance measurements in narrow spaces where the standard receptor won't fit. It can also be easily installed on various kinds of equipment or jigs for measuring light levels such as illumination.

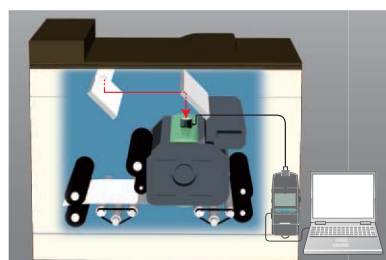

T-10W_sA (Cord length: 5 m)

T-10W_LA (Cord length: 10 m)

Conforms to JIS requirements for special illuminance meters

Waterproof

Custom order

The mini receptor and cord are both waterproof, so they can be used for measurements in water. They can be used for illuminance control for fishery-related applications (such as fish farming, etc.) or for measuring outdoor illuminance on rainy days.

Main Features

Reliable, worry-free illuminance meters that conform to JIS AA Class and DIN Class B

Illuminance Meters T-10A and T-10MA conform to Class AA of JIS C 1609-1: 2006 "Illuminance meters Part 1: General measuring instruments" and DIN 5032 Part 7 Class-B "Photometry; classification of illuminance meters and luminance meters" requirements to provide high-accuracy, high-reliability, worry-free measurements.

Illuminance meters conforming to these standards are required for measurements of general illumination light sources, white LED lamps for illumination, etc. in a variety of industrial fields.

Removable receptor

The receptor and main body can be detached from each other and then connected using a LAN cable, making it easy to install as part of an inspection system.

Compatible with PWM-controlled lighting. Enables measurements of next-generation light sources.

Conventional illuminance meters often cannot accurately measure PWM-controlled light sources, but the T-10A series of illuminance meters can be used to accurately measure even such light sources.

Easy, inexpensive multi-point measurement (2 to 30 points).

Illuminance distribution of a projector etc. can be easily measured with a single instrument and several receptors.



Multi-point illuminance measuring system

- 5-point example: Architectural lighting, etc.

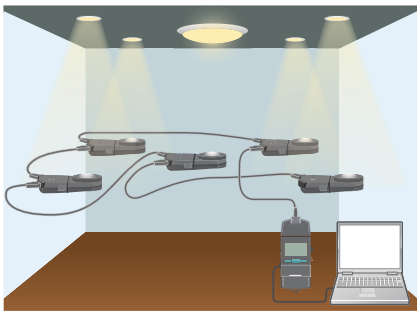

- 9-point example: Projectors, etc.

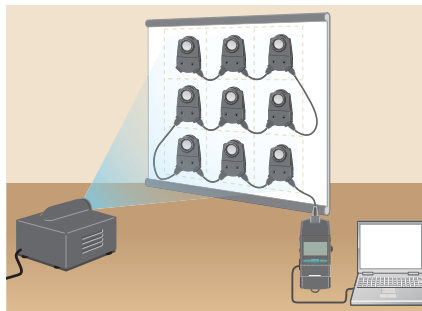

- 25-point example: Street lighting, etc.

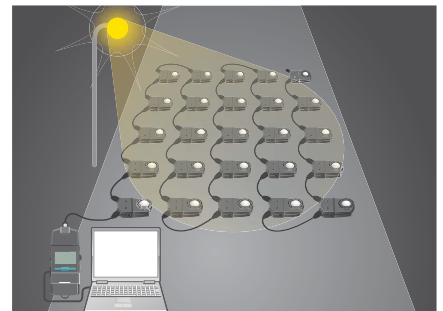

[T-10A 9-point measuring system composition]

Illuminant Meter T-10A	1 unit
T-10A Receptor Head	8 units
Adapter units for Main Body T-A20	1 unit
Adapter units for Receptor Head T-A21	9 units
AC Adapter	1 unit
Data Management Software T-S10w	1 set

Main applications

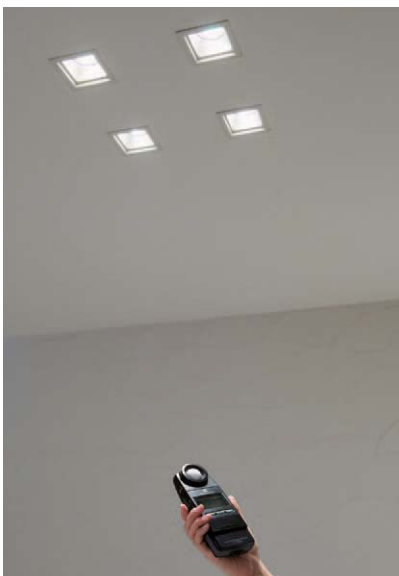

- Government testing organizations
- Research/inspection at illumination equipment makers
- Maintenance at factories, offices, hospitals, etc.

- Illuminance control of security lighting, street lighting, etc.
- As sensor for equipment measuring light-distribution characteristics, etc.

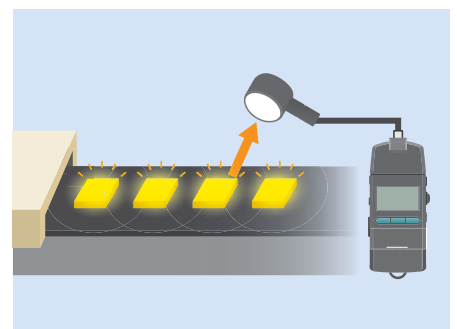

Convenient, easy-to-use Excel® add-in software

Reads measurement data from T-10A series Illuminance Meters directly into Excel®. Further processing of data can then be performed easily using the various functions of Excel®.

Main specifications of Data Management Software T-S10w

Type	Add-in for Excel® (Excel® is required to use this add-in.)
Operating environment	One of the following environments with Excel®: Windows® 7 Professional 32-bit + Excel® 2007 32-bit or Excel® 2010 32-bit Windows® 7 Professional 64-bit + Excel® 2007 32-bit or Excel® 2010 32-bit Windows® 8.1 Pro 32-bit + Excel® 2010 32-bit or Excel® 2013 32-bit Windows® 8.1 Pro 64-bit + Excel® 2010 32-bit or Excel® 2013 32-bit Windows® 10 Pro 32-bit + Excel® 2013 32-bit or Excel® 2016 32-bit Windows® 10 Pro 64-bit + Excel® 2013 32-bit or Excel® 2016 32-bit *OS languages® English, Japanese, Simplified Chinese, Traditional Chinese *For details on system requirements for above versions of Windows® and/or Excel®, refer to their respective specifications. *Not compatible with 64-bit versions of Excel®.
Compatible instruments	T-10A, T-10MA, T-10WsA, T-10WLA, T-10, T-10M, T-10Ws, T-10WL.

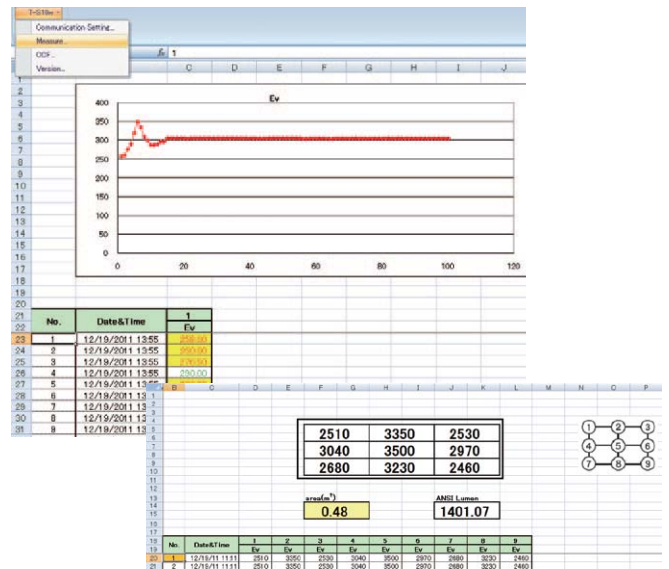

Relative Spectral Responsivity

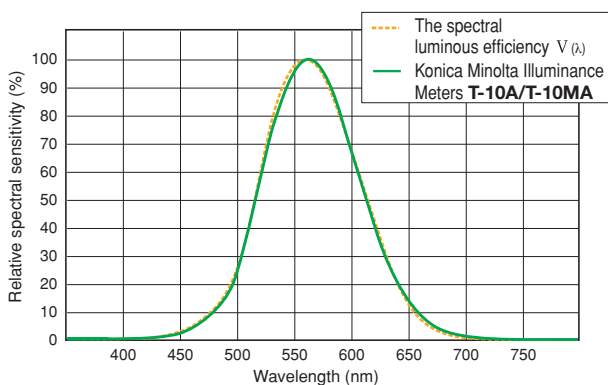

Ideally, the relative spectral responsivity of the illuminance meter should match $V(\lambda)$ of the human eye for photopic vision. As shown in the graph above, the relative spectral responsivity of Konica Minolta Illuminance Meters T-10A/10MA is within 6% ($f1'$) of the CIE spectral luminous efficiency $V(\lambda)$.

CIE ; Commission Internationale de l'Éclairage

$f1'$ (CIE symbol) ; The degree to which the relative spectral responsivity matches $V(\lambda)$ is characterized by means of the error $f1'$.

Cosine Correction Characteristics

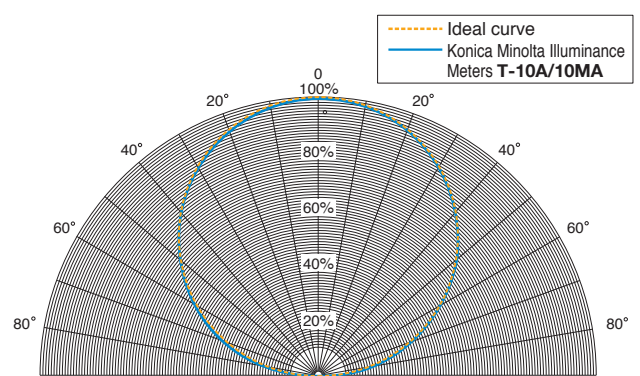

Since the brightness at the measurement plane is proportional to the cosine of the angle at which the light is incident, the response of the receptor must also be proportional to the cosine of the incidence angle.

For Konica Minolta Illuminance Meters T-10A/10MA, the cosine response $f2$ is within 3%.

The graph above shows the cosine correction characteristics of Konica Minolta Illuminance Meters T-10A/10MA.

About PWM-controlled lighting

PWM is the abbreviation of Pulse Width Modulation, and refers to the method of controlling signal intensity by controlling the ratio between the ON period and OFF period of a pulse signal.

A pulse signal is a signal which repeatedly alternates between ON and OFF, and the percentage of ON period during a single cycle is referred to as the "duty cycle".

PWM-controlled lighting is a method for controlling the brightness of a lamp by controlling the duty cycle (lit time) of light from a pulse-emission source. As the lit time becomes longer, the light becomes brighter, and conversely, as the lit time becomes shorter the light becomes darker.

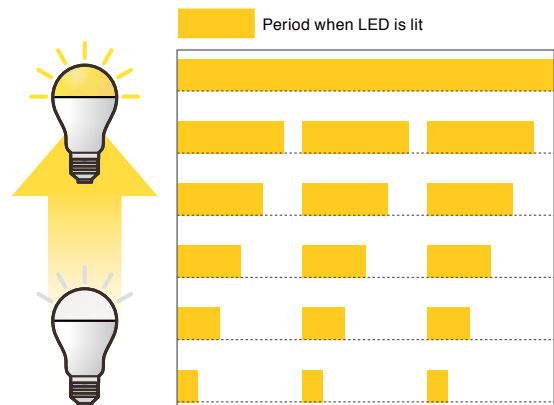

System Diagram

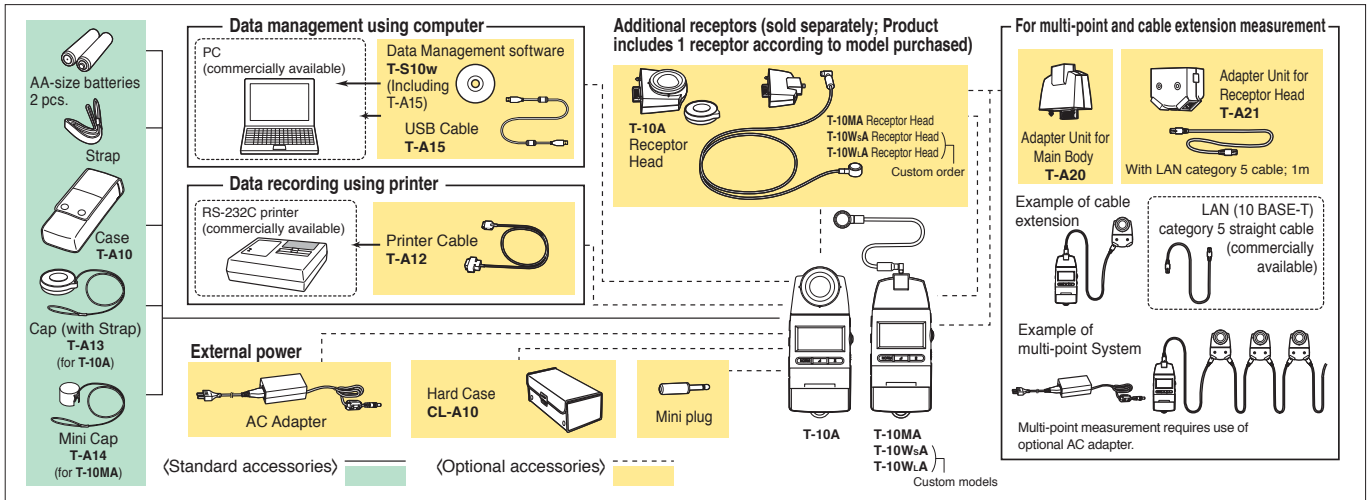

Main Specifications of T-10A

Model	Illuminance Meter T-10A (Standard receptor head)	Illuminance Meter T-10MA (Mini receptor head)	Illuminance Meter T-10WsA (Waterproof mini receptor head)	Illuminance Meter T-10WLA (Waterproof mini receptor head)
Type	Multi-function digital illuminance meter with detachable receptor head (Multi-point measurements of 2 to 30 points is possible)			
Illuminance meter class	Conforms to requirements for Class AA of JIS C 1609-1: 2006 "Illuminance meters Part 1: General measuring instruments" Conforms to DIN 5032 Part 7 Class B		Conforms to requirements for special illuminance meters of JIS C 1609-1: 2006 *1	
Receptor	Silicon photocell			
Relative spectral responsivity	Within 6% (f ₁) of the CIE spectral luminous efficiency V (λ)			
Cosine correction characteristics (f ₂)	Within 3%		Within 10%	
Measuring range	Auto range (5 manual ranges at the time of analog output)			
Measuring function	Illuminance (lx), illuminance difference (lx), illuminance ratio (%), integrated illuminance (lx-h), integration time (h), average illuminance (lx).			
Measuring range	Illuminance	0.01 to 299,900 lx; 0.001 to 29,990 fcd		1.00 to 299,900 lx; 0.1 to 29,990 fcd *2
	Integrated illuminance	0.01 to 999,900 x 10 ³ lx-h 0.001 to 99,990 x 10 ³ fcd-h / 0.001 to 9999 h		
User calibration function	CCF (Color Correction Factor) setting function: Measurement value x 0.500 to 2.000			
Linearity	±2% ±1 digit of displayed value			
Temperature/humidity drift	Within ±3%			
Measurement speed	2 times/sec. (continuous measurement with 1 receptor head)			
Computer interface	USB			
Printer output	RS-232C			
Analog output	1 mV/digit, 3 V at maximum reading; Output impedance: 10 KΩ; 90% response time: 28 ms			
Display	3 or 4 Significant-digit LCD with backlight illumination (Automatic illumination)			
Power	2 AA-size batteries / AC adapter AC-A308 (optional; for 1 to 10 receptors) or AC adapter AC-A311 (optional; for 1 to 30 receptors)			
Battery performance	72 hours or longer (when alkaline batteries are used) in continuous measurement			
Operation temperature/humidity range	-10 to 40°C, relative humidity 85% or less (at 35°C) with no condensation		5 to 40°C, relative humidity of 85% or less (at 35°C) with no condensation	
Storage temperature/humidity range	-20 to 55°C, relative humidity 85% or less (at 35°C) with no condensation		0 to 55°C, relative humidity of 85% or less (at 35°C) with no condensation	
Size (W x H x D)	69 x 174 x 35 mm	Main body: 69 x 161.5 x 30 mm Receptor: Ø16.5 x 13.8 mm		
Cord length	-	1 m	5 m	10 m
Weight (without battery)	200 g (7.0 oz.)	205 g	260 g (Receptor head only: 120 g)	340 g (Receptor head only: 200 g)

*1 Conforms to requirements for Class AA of JIS C 1609-1: 2006 for all items except cosine response (f₂).

*2 Although measurements below 1.00 lx are possible, they may not be stable due to the effects of electrical noise.

<Notes regarding mini receptors and waterproof mini receptors>

*Do not touch the cable during measurements. Doing so may result in unstable measurement values.

*Secure the cable during measurements. Failure to do so may result in unstable measurement values.

Dimensions (Units: mm)

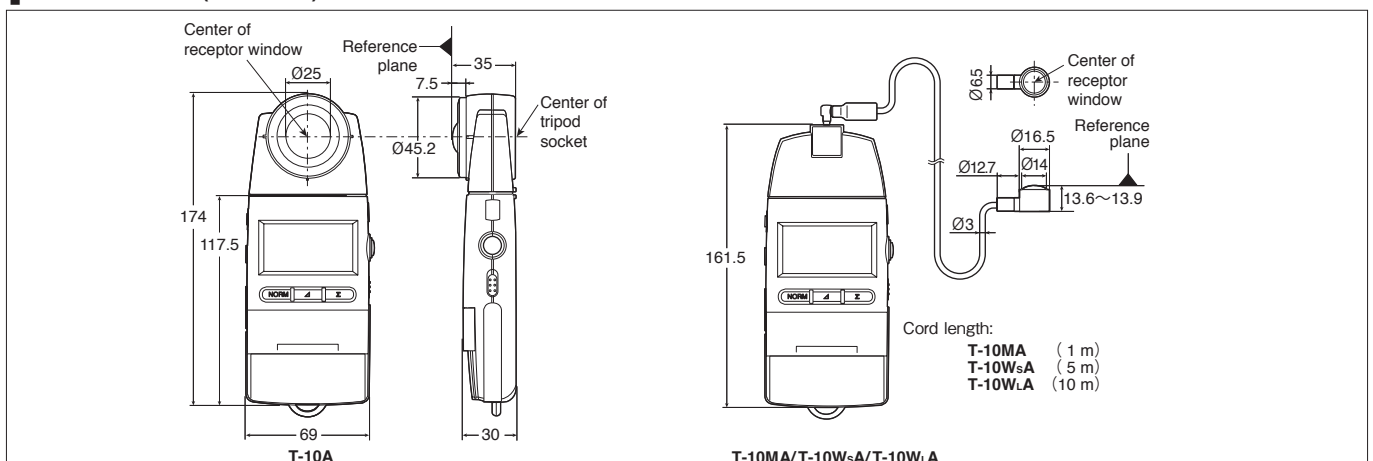

Chroma Meter CL-200A

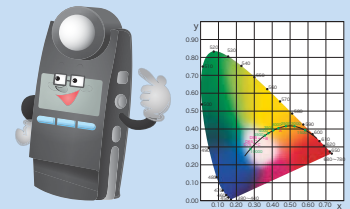

De facto industry standard for measuring color temperature!
Can also measure illuminance (JIS AA class)

Main Features

Compact and easy to carry

The CL-200A's compact body fits in your palm. Battery-powered so it can be taken along and used anywhere.



Excel® add-in software included

Data Management Software CL-S10w
(Standard accessory)

Easy, convenient Excel® add-in

Measurement data from the CL-200A can be transferred directly into Excel®. The transferred data can then be managed freely within Excel®.

Data transfer using main body buttons

When using the CL-200A with Data Management Software CL-S10w (included), measurements can be taken and data transferred to Excel® using the main body buttons as well as computer keys.

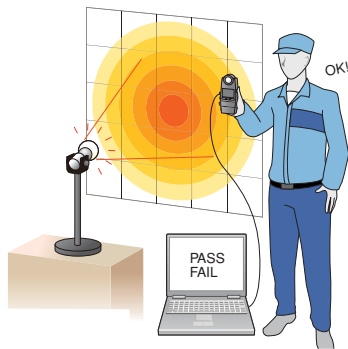

Includes LED ranking function

Color variations, the top topic in the LED industry, can be quantified and a ranking function is also provided.

JIS correlated color temperature

Correlated color temperature is determined using the equations defined by JIS (Japanese Industrial Standards).

Multi-point measurement and user calibration also possible

Multi-point measurement management using up to 30 receptor heads is possible.

User calibration function enables compensation of measurement values to match a desired standard. Calibration can be performed by two methods: Single-point calibration or RGB calibration.

Detachable receptor head

The receptor head can be detached and then connected to the main body using a normal LAN cable*, making it easy to install the sensor in an inspection system.

* Optional Adapter Units required for receptor head and main body

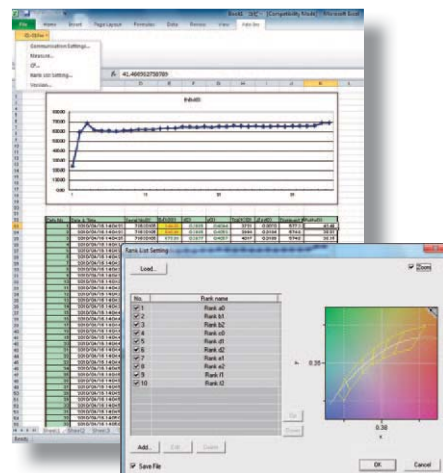
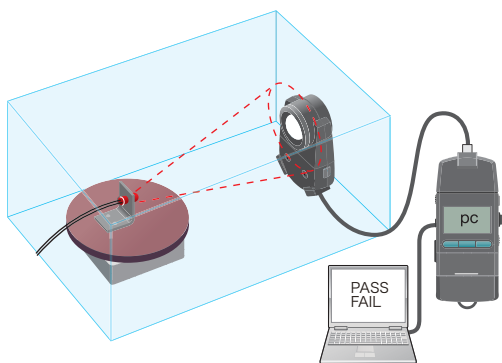

Measures color temperature and Chromaticity!



Measures dominant wavelength!



Even measures excitation purity!



Application examples

For lighting production and adjustment

When using various types of light sources in a room or open space, it is sometimes necessary to check the color of the lighting. By using the CL-200A, it is possible to adjust the lighting color so that the food in a restaurant looks delicious.



For evaluating light source characteristics

Evaluation of the light distribution of LED illumination modules or the illuminance distribution of lighting fixtures can be evaluated.

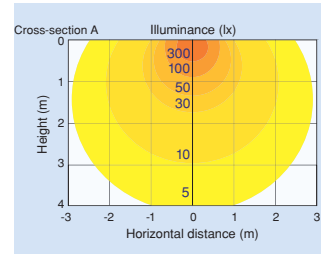

For color-viewing cabinet maintenance

A color-viewing cabinet like that shown at left is used in industries such as the printing industry to visually evaluate finished work under controlled conditions. This color-viewing cabinet provides illumination at a specific illuminance and color temperature by using fluorescent lamps, halogen lamps, etc. The CL-200A can be used for the daily maintenance and control of these lamps as well as to indicate when replacement is needed.



For projector light-source research and color inspection

The CL-200A can be used to measure the white balance and uniformity of microprojectors, etc. with internal LED light sources. The ability to connect multiple receptors using LAN cables enables measurement of not only a single point in the center, but up to a maximum of 30 points over the entire projected area.



For LED billboard development and maintenance

The CL-200A enables quality control of the LED modules for digital signage to be performed easily. If modules with different color tones are used together, the billboard will look mottled, but by measuring the chromaticity and color temperature of modules using the CL-200A and selecting modules based on measured values, billboard uniformity can be achieved.



Multi-point illuminance measuring system

● 5-point example: Architectural lighting, etc.

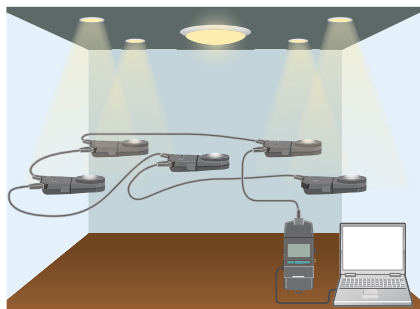

● 9-point example: Projectors, etc.

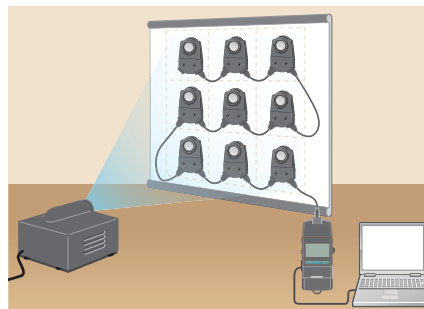

● 25-point example: Street lighting, etc.

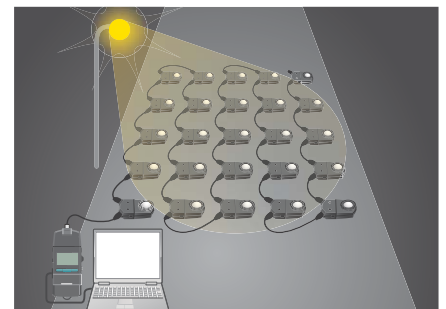

[CL-200A 9 point measuring system composition]

Chroma Meter CL-200A	1 unit
CL-200A Receptor Head	8 units
Adapter Unit for Main Body T-A20	1 unit
Adapter Unit for Receptor Head T-A21	9 units
AC Adapter	1 unit
Data Management Software CL-S10w	1 set

CL-200A

The CL-200A has sensors that closely match the CIE*-defined color-matching functions which are intended to correspond to the response of the human eye to enable precise color measurement. The measurement results can be displayed in various color notations such as "Correlated color temperature and Δuv " according to the application.

*CIE: International Commission on illumination

Photographic color meter

In order to take more beautiful pictures, it is sometimes necessary to attach filters in front of the camera lens to compensate for the color of the light illuminating the subject. A photographic color meter is a meter used to select the appropriate filters, with the sensitivity of its sensors adjusted to match that of the film or digital camera sensor. In addition, because it uses photographic color temperature, which is calculated based mostly on the blue/red balance of the illumination, large errors may occur if it is used to measure light sources with non-continuous spectrums.

[Actual measurement data for daylight-color LED bulb]

	Measured color temperature	Color-temperature difference from standard-instrument measured value
Our company's standard instrument	5,045	0
CL-200A	5,011	-34
Photographic color meter	5,600	555

Color temperature and correlated color temperature

Color temperature

When an ideal blackbody* is heated, it begins to emit light, and as the temperature increases the color of the emitted light changes from red to yellow to white. Since the color of the emitted light is determined by the temperature of the blackbody, the color of the light emitted by the blackbody can be expressed as the absolute temperature of the blackbody (in Kelvin). This color notation scale is called "color temperature". For example, a 7000 K color would be the color of the light emitted by a blackbody heated to 7000 K. Figure 1 shows the color of light emitted by a blackbody at various temperatures plotted on an xy chromaticity diagram. This curve is called the "blackbody locus"; "color temperature" expresses a color on this blackbody locus.

Correlated color temperature

Since the color of white light emitted by illumination equipment and displays is generally close to the blackbody locus, the color of such light sources is normally expressed using "color temperature".

However, the color of such light sources is not directly on the blackbody locus. Because of this, a way to enable similar color expression for colors within a larger region close to the blackbody locus was devised. This is called "correlated color temperature", and the larger region is shown by the isotherms on the xy chromaticity diagram in Figure 2.

To accurately express the correlated color temperature of a light-source color, it is necessary to state not only the correlated color temperature but the difference from the blackbody locus, normally in terms of Δuv .

*Blackbody

An ideal radiator. A body which completely absorbs all incident electromagnetic radiation. Although a perfect blackbody does not actually exist, coal is a familiar object that acts similarly.

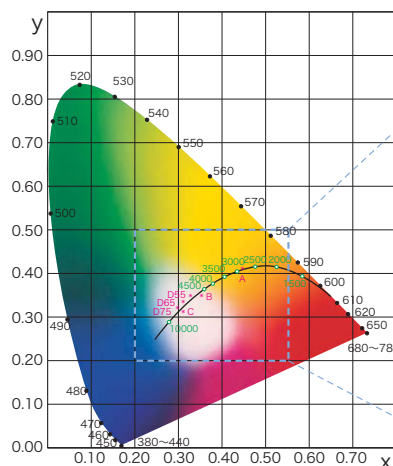

Figure 1: Blackbody locus on xy chromaticity diagram

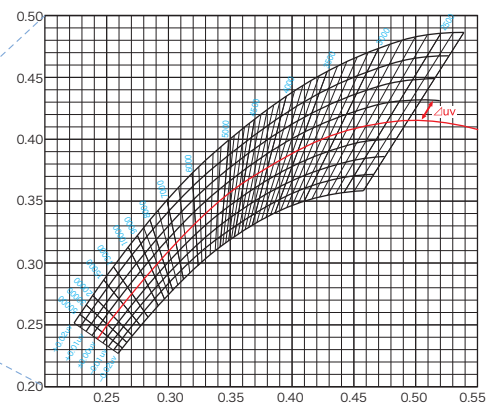
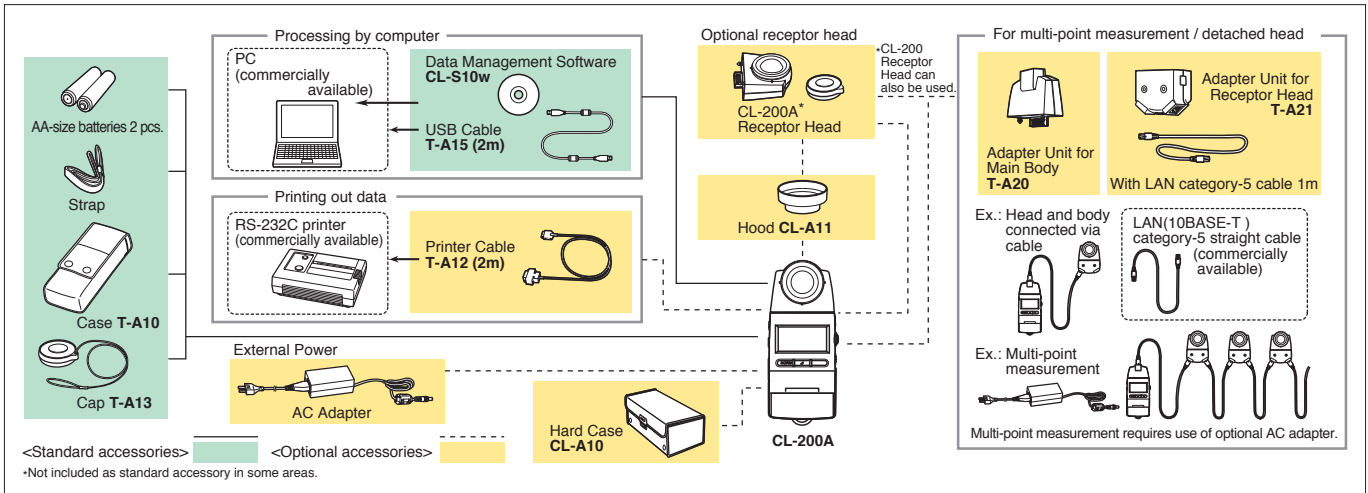

Figure 2: Closeup of blackbody locus on xy chromaticity diagram showing correlated color temperature region

System Diagram



Main Specifications of Chroma Meter CL-200A

Model	Chroma Meter CL-200A
Illuminance meter class	Conforms to requirements for Class AA of JIS C 1609-1: 2006 "Illuminance meters Part 1: General measuring instruments"
Relative spectral responsivity	Closely matches CIE Standard Observer curves $\bar{x}(\lambda)$, $\bar{y}(\lambda)$, and $\bar{z}(\lambda)$ Within 6% (f_1) of the CIE spectral luminous efficiency $V(\lambda)$
Cosine correction characteristics (f_2)	E_V : Within 3%
Receptor	Silicon photocell
Measuring function	Tristimulus values: XYZ Chromaticity: E_Vxy ; $E_Vu'v'$; E_V , Dominant wavelength, Excitation purity Correlated color temperature: $E_VT_{cp}\Delta uv$; T_{cp} (JIS method; available only with CL-S10w) Color difference: $\Delta(XYZ)$, $\Delta(E_Vxy)$, $\Delta(E_Vu'v')$, $\Delta E_V\Delta u'v'$ (Target: 1)
Other function	User calibration function, Data hold function, Multi-point measurement (2 to 30 points)
Measuring range	0.1 to 99,990 lx, 0.01 to 9,999 fcd (Chromaticity: 5 lx, 0.5 fcd or above) in four automatically selected ranges (lx or fcd is switchable)
Accuracy*	E_V (Linearity): $\pm 2\% \pm 1$ digit of displayed value xy : ± 0.002
Repeatability*	E_V : $0.5\% + 1$ digit (2 σ), xy : ± 0.0005
Temperature drift	E_V : $\pm 3\% \pm 1$ digit of displayed value, xy : ± 0.003
Humidity drift	E_V : $\pm 3\% \pm 1$ digit of displayed value, xy : ± 0.003
Measurement speed	2 times/sec. (continuous measurement with 1 receptor head)
Computer interface	USB
Printer output	RS-232C
Display	4-significant-digit LCD with back-light illumination
Operation temperature/humidity range	-10 to 40°C, relative humidity 85% or less (at 35°C) with no condensation
Storage temperature/humidity range	-20 to 55°C, relative humidity 85% or less (at 35°C) with no condensation
Power	2 AA-size batteries / AC adapter AC-308 (optional; for 1 to 10 receptors) or AC adapter AC-311 (optional; for 1 to 30 receptors)
Battery performance	72 hours or longer (When alkaline batteries are used) in continuous measurement
Size (W x H x D)	69 x 174 x 35 mm (2-6/16x6-14/16x1-7/13in.)
Weight	215 g (7.6 oz.) not including batteries

* 800 lx, Standard Illuminant A measured

Dimensions (Units: mm)

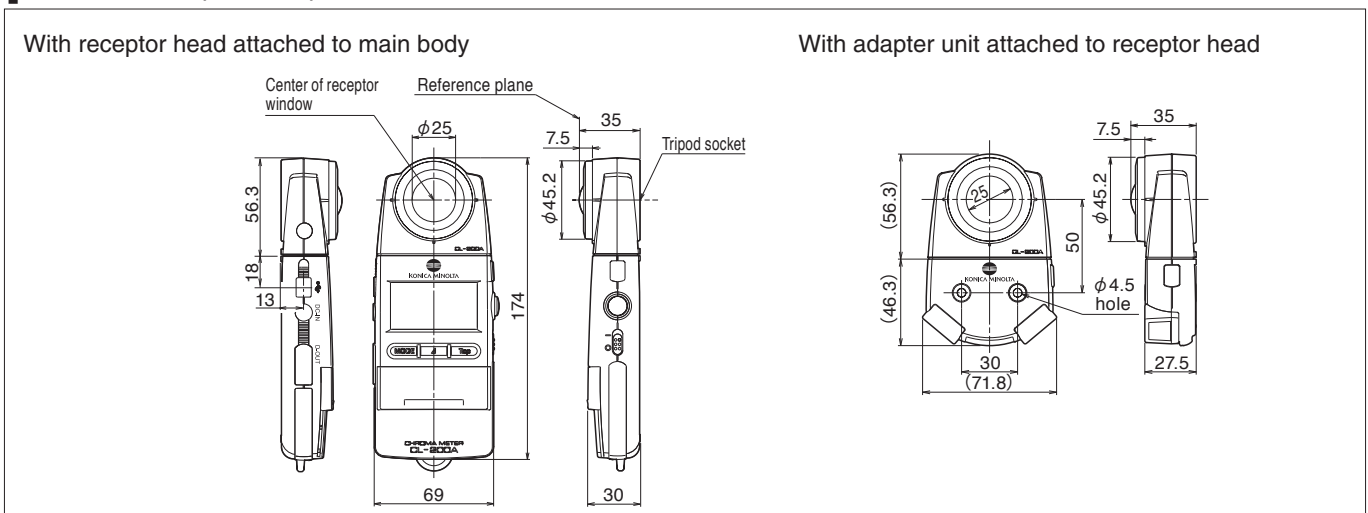

Main Specifications of Data Management Software CL-S10w

Type	Add-in for Excel® * Excel is required to use this add-in.
Operating environment	One of the following environments: Windows® 7 Professional 32-bit or 64-bit + Excel® 2007 32-bit or Excel® 2010 32-bit Windows® 8.1 Pro 32-bit + Excel® 2010 32-bit or Excel® 2013 32-bit Windows® 8.1 Pro 64-bit + Excel® 2010 32-bit, Excel® 2013 32-bit, or Excel® 2013 64-bit Windows® 10 Pro 32-bit + Excel® 2013 32-bit or Excel® 2016 32-bit Windows® 10 Pro 64-bit + Excel® 2013 32-bit or 64-bit, or Excel® 2016 32-bit or 64-bit • OS languages: English, Japanese, Simplified Chinese, Traditional Chinese • For details on system requirements for above versions of Windows® and/or Excel®, refer to their respective specifications.
Compatible instruments	CL-200A, CL-200*, CL-500A * Some functions not usable with CL-200.

Illuminance Spectrophotometer CL-500A

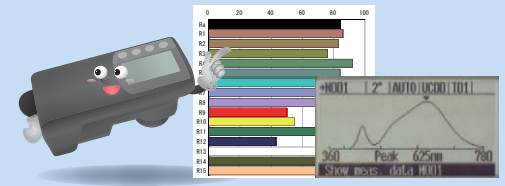

For evaluation of high-class next-generation lamps such as LED illumination and EL illumination

Now scotopic illuminance can also be measured.

Main Features

Handheld illuminance spectrophotometer conforms to both DIN and JIS standards.

The CL-500A conforms to DIN 5032 Part 7 Class B and JIS C 1609-1:2006 General Class AA, making it the first compact, lightweight, handheld illuminance spectrophotometer to conform to both DIN and JIS standards.

All-in-one type. No PC needed.

The CL-500A can be used by itself for measuring CRI or color temperature of lamps. In addition, the spectral irradiance waveform and peak wavelength can also be checked.

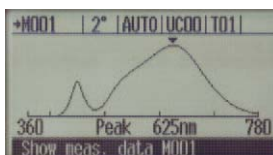

Measurement of spectral irradiance (w/m²) at each wavelength.

The spectral irradiance can be measured at 1-nm pitch from 360 to 780 nm, so the CL-500A can be used not only for measuring the color of light but also for measuring photosynthetic photon flux density (PPFD).

Measures and displays both the general color-rendering index Ra as well as the special color-rendering indexes R1 to R15.

The special color-rendering indexes R1 to R15 can be displayed, so the color-rendering index for a specific color such as for R9 (red) or R15 (skin color) can be easily measured and displayed.

Scotopic illuminance can also be measured.

Most conventional illuminance meters can only measure photopic illuminance, but the CL-500A can also measure *scotopic (dark-adapted) illuminance both with the instrument alone and when used with the included software. Plus, the S/P ratio of scotopic illuminance and photopic illuminance can also be displayed.

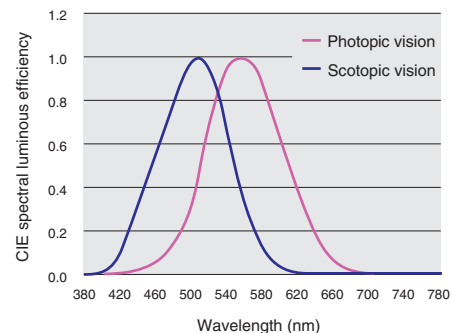

* Scotopic vision vs. photopic vision

The sensitivity of the human eye under low-light conditions is different than that under bright conditions. The vision of the human eye under low-light conditions is termed "scotopic vision", with a sensitivity peak wavelength which is shifted toward the shorter wavelengths compared to vision under bright conditions, which is termed "photopic vision". The respective spectral luminous efficiency curves for each type of vision are shown at right.

Convenient measurement functions

- 1) Continuous measurement mode :
For monitoring changes in illuminance levels or spectral power distribution.
- 2) Display of the average of multiple measurements :
Useful for evaluation of projectors, etc.
- 3) Delayed-measurement function :
The CL-500A can be set to wait for a specific time after the measuring button is pressed before starting measurements, so you can get out of the way before the measurement is taken to make sure that light reflected from you or your clothes do not affect measurements.
- 4) Display of data at specific wavelength :
Allows monitoring of spectral irradiance at a specific wavelength.

Convenient, easy-to-use Excel® add-in software

Reads measurement data from the CL-500A directly into Excel®. Further processing of data can then be performed easily using the various functions of Excel®.

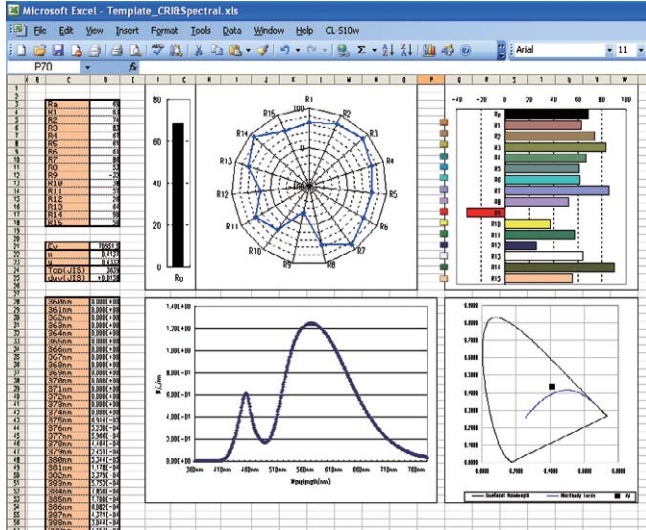

Informative color-rendering index display

Color-rendering indexes are shown visually for easy understanding. The shifts between a test light source and a standard light source can be seen at a glance, with bar graphs showing the general color-rendering index Ra (the average of special color-rendering indexes R1 to R8) and the special color-rendering indexes for a total of 15 colors (R1 to R15).

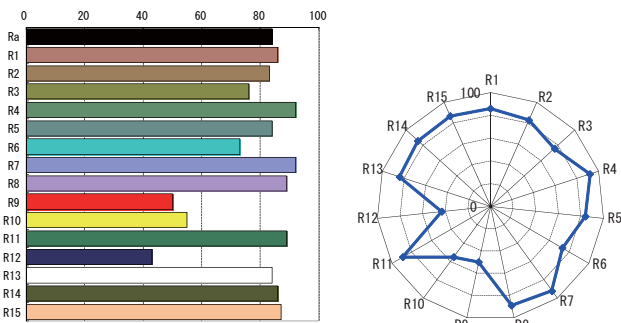

MacAdam SDCM level display

CL-S10w includes a template for expressing the chromaticity variation of illumination light sources such as LEDs or organic EL sources in terms of the MacAdam SDCM (Standard Deviation of Color Matching) step. This allows display of color differences that closely match visual judgement.

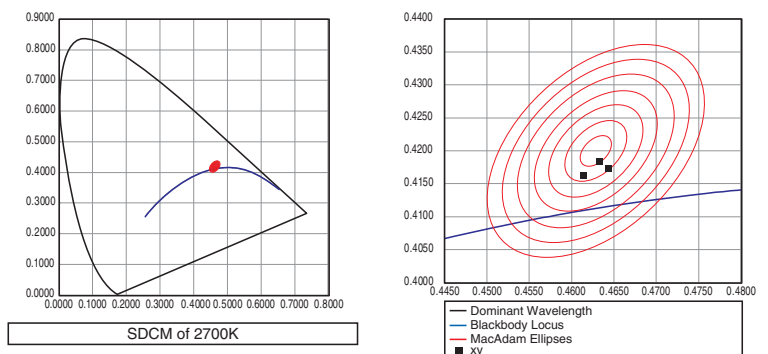

Spectral irradiance waveform display

Since peak wavelengths can be seen easily, classification and grading of light sources can be performed easily at high accuracy. In addition, numerical data at 1 nm can also be viewed in list form.

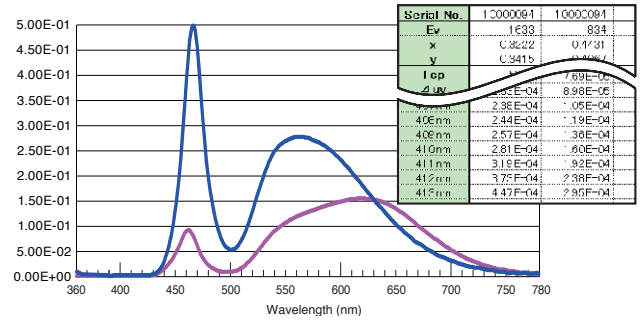

Multi-point measurement possible using multiple CL-500A units

Data Management Software CL-S10w can be used to control up to 10 CL-500A units for multi-point measurements. Using the SDK, this can be further expanded. Please contact our sales person for further information.

Equipped with LED binning function

In addition to quantifying the color variations which are a major problem in the LED industry, the software is also equipped with function to enable easy binning.

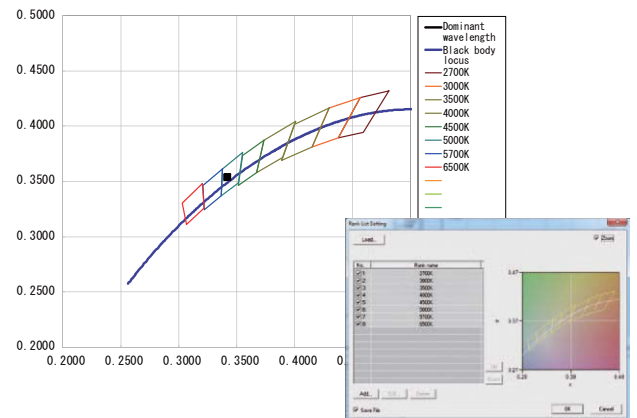

What is color-rendering property?

Colors are generally compared by arranging objects side-by-side and looking at them under natural light (sunlight).

When comparing how lamps such as fluorescent lamps, LEDs (light emitting diodes), etc. make objects look against how natural light makes them look, how closely the appearances match is called the “color-rendering property” of the lamp. A lamp that produces a hue similar to that of natural light is said to have a good (high) color-rendering property. The color-rendering index is an objective quantification of the color-rendering properties of a light source. The color-rendering index expresses the comparison between the light source being tested and a standard illuminant*. The maximum value is 100, with the value decreasing as the color-rendering difference increases, indicating how far the appearance under the test light source is from the natural color under sunlight.

* Standard illuminant with the same color temperature as the light source being tested. (Light along the blackbody locus corresponds to sunlight.)

Standard illuminant
(CIE daylight)



Light source being tested



Color-rendering indexes include the general color-rendering index (Ra) and special color-rendering indexes (R1 to R15)

Test - color samples

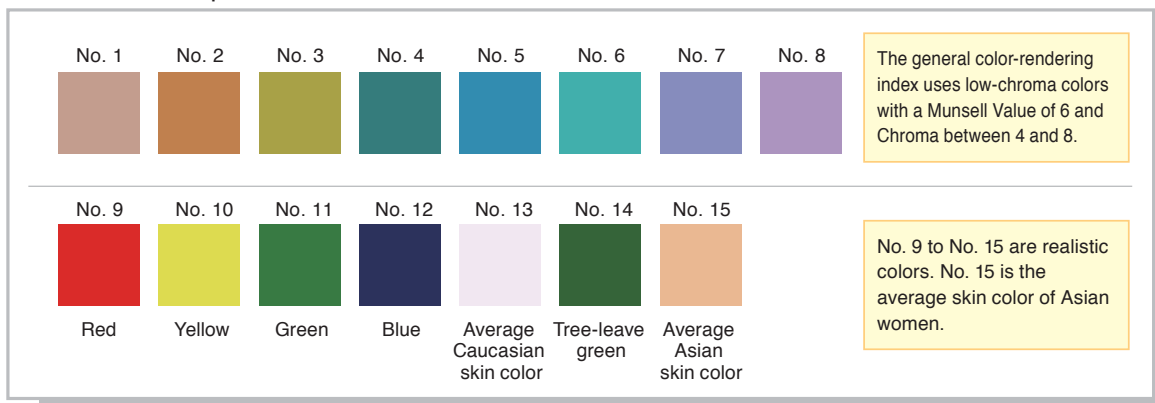

General color-rendering index (Ra)	The average of the color-rendering indexes for test colors No. 1 to 8.
Special color-rendering indexes (Ri)	The individual color-rendering index for test colors No. 1 to 15 (The index for each individual color is evaluated.)

To learn more about the theory and practice of light and color measurement, please visit

<http://www.konicaminolta.com/instruments/knowledge/index.html>

Konica Minolta Measurement Fundamentals



Main applications

- Measurement and evaluation of the illuminance, color temperature, and color-rendering index of indoor illumination sources such as LEDs, organic EL sources, fluorescent lamps, etc.
- Measurement and evaluation of the illuminance, color temperature, and color-rendering index of special illumination sources used for TV broadcasting stations, studios, stages, events, etc.
- Measurement of ambient lighting including sunlight.
- Measurement of the illumination and color temperature of various types of projectors.
- Measurement of the photosynthetic photon flux density (PPFD) of light sources used for agriculture.
- Standard instrument for illuminance meters or illuminance colorimeters.



System Diagram

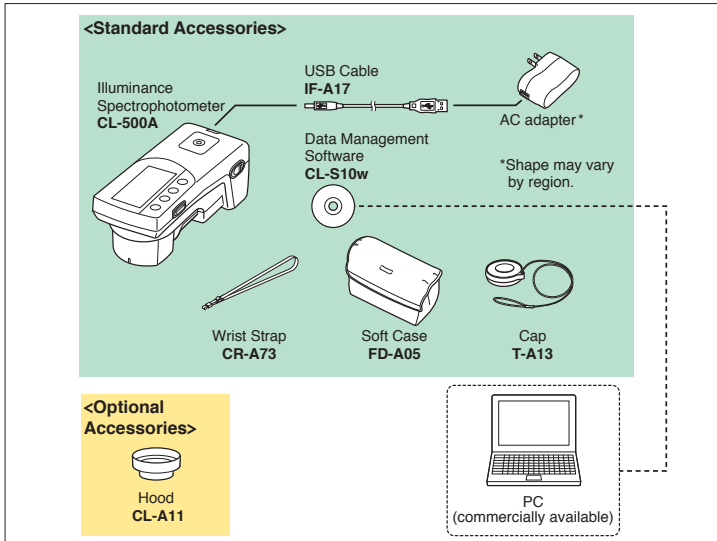

Dimensions (Units: mm)

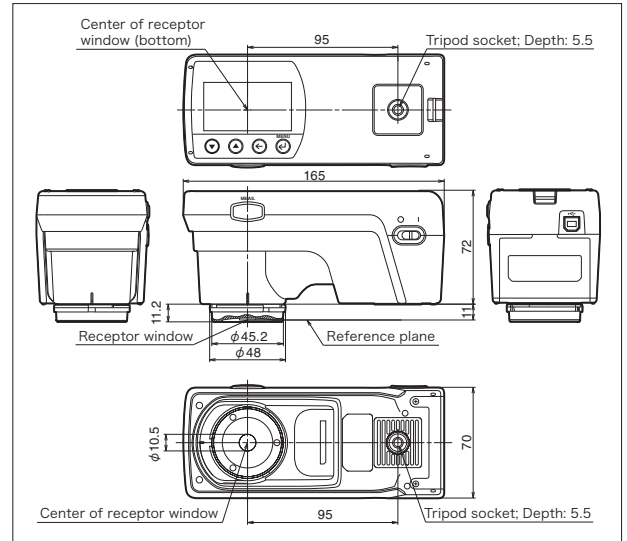

Main Specifications of CL-500A

Model	Illuminance Spectrophotometer CL-500A
Illuminance meter class	Conforms to requirements for Class AA of JIS C 1609-1: 2006 *Illuminance meters Part 1: General measuring instruments** Conforms to DIN 5032 Part 7 Class B
Wavelength range	360 to 780 nm
Output wavelength pitch	1 nm
Spectral bandwidth	Approx. 10 nm (half bandwidth)
Wavelength precision	± 0.3 nm (Median wavelengths of 435.8 nm, 546.1 nm, and 585.3 nm** as specified in JIS Z 8724)***)
Measuring range	0.1 to 100,000 lx (chromaticity display requires 5 lx or more)
Accuracy*4,5 (Standard Illuminant A)	E_v (Illuminance) : $\pm 2\% \pm 1$ digit of displayed value xy: ± 0.0015 (10 to 100,000 lx) xy: ± 0.002 (5 to 10 lx)
Repeatability (2σ)*4 (Standard Illuminant A)	E_v : 0.5%+1 digit xy: 0.0005 (500 to 100,000 lx) xy: 0.001 (100 to 500 lx) xy: 0.002 (30 to 100 lx) xy: 0.004 (5 to 30 lx)
Visible-region relative spectral responsivity characteristics (f_v)	Within 1.5% of spectral luminous efficiency $V(\lambda)$
Cosine correction characteristics (f_c)	E_v : Within 3%
Temperature drift (f_T)	E_v : $\pm 3\%$ of displayed value; xy: ± 0.003
Humidity drift (f_H)	E_v : $\pm 3\%$ of displayed value; xy: ± 0.003
Measurement time	Super Fast mode: Approx. 0.2 sec. (when connected to computer); Fast mode: Approx. 0.5 sec.; Slow mode: Approx. 2.5 sec.; Automatic exposure time setting (high accuracy) mode: Approx. 0.5 to 27 sec.
Display mode	XYZ; $X_{10}Y_{10}Z_{10}$; E_v, xy ; $E_v, u'v'$; E_v ; Dominant wavelength, Excitation purity; Correlated color temperature, Δu ; General color-rendering index (Ra); Special color-rendering indexes (R_i ($i=1-15$)); Spectral graph; Peak wavelength; Δ (XYZ); Δ ($X_{10}Y_{10}Z_{10}$); Δ (E_v, xy); Δ ($E_v, u'v'$); Rank display; Scotopic illuminance; S/P ratio; Spectral irradiance
Other functions	Data memory: 100 data; User calibration function (when connected to computer); Continuous measurement (when connected to computer); Auto power off function
Display languages	English, Japanese, Chinese (Simplified)
Interface	USB 2.0
Power	Rechargeable internal lithium-ion battery (Operating time per charge: Approx. 6 hours when new); AC adapter; USB power bus
Operation temperature/humidity range	-10 to 40°C, relative humidity of 85% or less (at 35°C) with no condensation
Storage temperature/humidity range	-10 to 45°C, relative humidity of 85% or less (at 35°C) with no condensation
Size (W x H x D)	70 x 165 x 83 mm
Weight	350 g

*1 For Section 7.6.3 Response Time, when measurement speed mode is set to FAST mode.

*2 For 585.3 nm, evaluation performed using substitute wavelength of 587.5 nm.

*3 Based on Konica Minolta test standards (change in temperature of 2°C or less after zero calibration.)

*4 Automatic exposure time setting (high accuracy) mode

*5 Linear for E_v (Illuminance)

Main Specifications of Data Management Software CL-S10w

Type	Add-in for Excel® (Excel® is required to use this add-in.)
Operating environment	One of the following environments: Windows® 7 Professional 32-bit or 64-bit + Excel® 2007 32-bit or Excel® 2010 32-bit Windows® 8.1 Pro 32-bit + Excel® 2010 32-bit or Excel® 2013 32-bit Windows® 8.1 Pro 64-bit + Excel® 2010 32-bit, Excel® 2013 32-bit, or Excel® 2013 64-bit Windows® 10 Pro 32-bit + Excel® 2013 32-bit or Excel® 2016 32-bit Windows® 10 Pro 64-bit + Excel® 2013 32-bit or 64-bit, or Excel® 2016 32-bit or 64-bit • OS languages: English, Japanese, Simplified Chinese, Traditional Chinese • For details on system requirements for above versions of Windows® and/or Excel®, refer to their respective specifications.
Compatible instruments	CL-500A, CL-200A, CL-200* * Some functions not usable with CL-200.
Display items	Spectral irradiance ($W/m^2/nm$); Illuminance; general color-rendering index Ra; correlated color temperature; etc.

CRI Illuminance Meter CL-70F

Conforms to JIS A Class and DIN Class C

Easy to use !

Can take spectral measurements of flash light

Good tool for lighting planners



The CL-70F CRI Illuminance Meter is an entry-level solution for the measurement and evaluation of the illuminance, color temperature, and color rendering index (CRI) of various illumination sources such as LEDs and fluorescent lamps.

Main Features

Rotating receptor head



Easy-to-read display

*Display mode examples

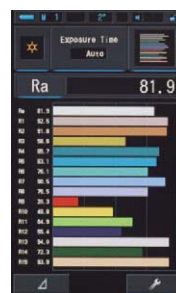

Color rendering index

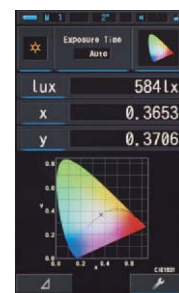

CIE1931
(CIE1964)

Dark calibration performed without needing cap

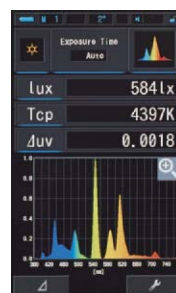

Spectrum



Text

Main applications

Measurement/evaluation of illuminance, color-temperature, and color-rendering index of:

- Special illumination sources used for restaurants, museums, studios, and stages, etc.
- Indoor illumination sources such as LEDs, fluorescent lamps, etc.



System Diagram

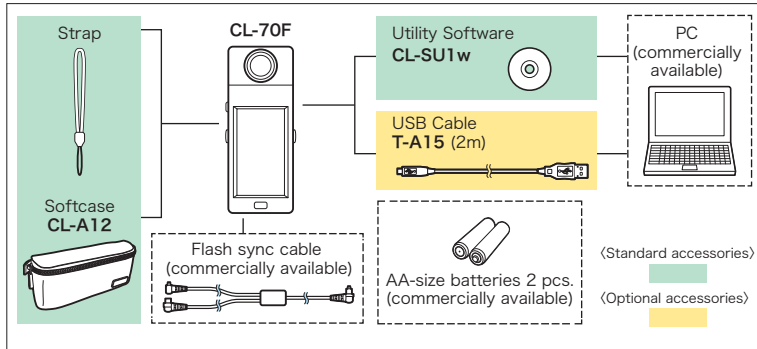

Dimensions (Units: mm)

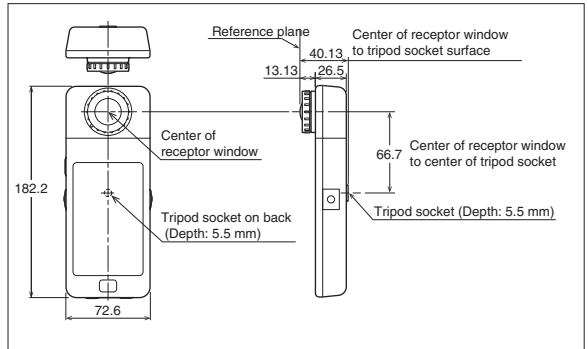

Main Specifications of CL-70F

Model	CRI Illuminance Meter CL-70F
Illuminance meter class	Conforms to requirements for Class A of JIS C1609-1 : 2006 "Illuminance meters Part1:General measuring instruments; Conforms to DIN 5032 Part 7 Class C
Sensor	CMOS linear image sensor
Spectral wavelength range	380 nm to 780 nm
Output wavelength pitch	1 nm
Measuring range	Constant light: 1 to 200,000 lx; 1,563 to 100,000 K (Chromaticity display requires 5 lx or more) Flash light: 20 to 20,500 lx·s; 2,500 to 100,000 K
Accuracy (Standard Illuminant A) (*1, 2)	E_v : $\pm 5\% \pm 1$ digit of displayed value xy : ± 0.003 (at 800 lx)
Repeatability (Standard Illuminant A) (*1)	E_v : 30 to 200,000 lx: $1\% + 1$ digit; 1 to 30 lx: $5\% + 1$ digit (*3) xy : 500 to 200,000 lx: 0.001 (*4) xy : 100 to 500 lx: 0.002 (*4) xy : 30 to 100 lx: 0.004 (*4) xy : 5 to 30 lx: 0.008 (*4)
Visible-region relative spectral response characteristics (f1')	Within 9%
Cosine correction characteristics (f2)	Within 6%
Temperature drift (f _t)	E_v : $\pm 5\%$ xy : ± 0.006
Humidity drift (f _h)	E_v : $\pm 3\%$ xy : ± 0.006
Power	2 AA-size batteries (Alkaline batteries or manganese dry cells); USB bus power
Response time	Constant light (Maximum): 15 sec Constant light (Minimum): 0.5 sec Flash light: 1 to 1/500 sec (in 1-step intervals) (*5)
Color indication modes	Correlated color temperature T_{cp} , Difference from blackbody Δuv , XYZ, xy , $u'v'$, Dominant wavelength λ_d , Excitation purity P_e , Spectral irradiance, E_v , CRI (Ra, Ri), Peak wavelength λ_p , exposure value
Other functions	Data memory: 999 data; Preset function; Auto power off function
Display languages	English, Japanese, Chinese (Simplified)
Interface	USB 2.0 Mini B
Operation temperature/humidity range	-10 to 40°C, relative humidity of 85% or less (at 35°C) with no condensation
Storage temperature/humidity range	-10 to 45°C, relative humidity of 85% or less (at 35°C) with no condensation
Size	73 (W) × 183 (H) × 27 (D) mm (Not including projecting buttons) D (max): 40 mm
Weight (without battery)	230 g

(*1) Measurement mode: Constant light (range L), Exposure time AUTO

(*2) Linear for E_v

(*3) 10 times measurement (2σ) / Ave

(*4) 10 times measurement (2σ)

(*5) Shutter speed

Utility Software (Standard accessory)

Software	OS	
Windows	Windows® 7 SP1, Windows® 8, Windows® 8.1	Compatible with 32-bit and 64-bit versions of Excel®

• Windows® and Excel® are trademarks of Microsoft Corporation in the USA and other countries.

Luminance Meter LS-150/LS-160

New models with higher accuracy and comfort of use!

Conforms to DIN 5032-7 Class B

(LS-150)



Luminance Meter LS-150

Luminance Meter LS-150 measures color and luminance with 1° measuring angle across a 0.001 to 999,900 cd/m² range.

Luminance Meter LS-160

Luminance Meter LS-160 measures color and luminance with 1/3° measuring angle across a 0.01 to 9,999,000 cd/m² range.

Main Features

High accuracy

The LS-150 and LS-160 are highly accurate luminance meters that use a newly designed sensor with a spectral response that more closely matches the V(λ) spectral luminous efficiency function of the human eye to provide measurement results that correlate well with visual evaluation.

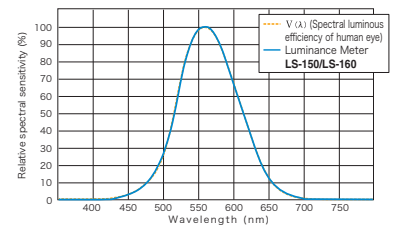
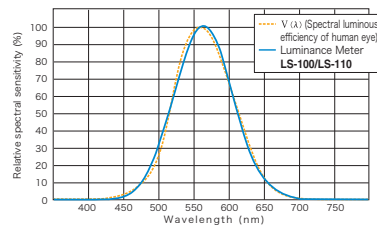

Incredibly easy to use

- Automatic mode automatically sets the measurement time according to the brightness of the target.
- Bright viewfinder makes it easy to target desired areas of measurement subjects.

- Backlit display is easy to read even in dark places, and is automatically switched off during measurements.

- Easy-to-hold grip. Smooth focusing during measurement.



Numerous optional accessories

Close-up lenses

Lineup of 4 lenses (Nos. 153, 135, 122, and 110) enable measurements of tiny areas.



Measuring distance and measuring area (Units:mm)

(Measuring angle)	Minimum measuring area		Maximum measuring area		Minimum measuring distance	Maximum measuring distance
	1/3°	1°	1/3°	1°		
None	4.5	14.4	∞	∞	1,012	∞
No.153	2.5	8	5.9	18.8	627	1,219
No.135	1.6	5.2	2.7	8.6	455	625
No.122	1.0	3.2	1.3	4.3	331	378
No.110	0.4	1.3	0.5	1.5	213	215

*Measuring distance is the distance from the measuring distance reference plane.

C-mount CCD camera adapter enables the viewfinder to be monitored from a distance.

This adapter allows an industrial C-mount CCD camera to be attached to the viewfinder so that measurements including the view through the viewfinder can be monitored from a distance or recorded.

* CCD camera not included.



Illuminance adapter enables illuminance to also be measured.



Measurable illuminance range:

LS-150: Corresponds to 0.015 - 999,900 lx

LS-160: Corresponds to 0.15 - 9,999,000 lx

* This illuminance measuring method does not conform to DIN or JIS standards.

Easy-to-understand utility software

The included software allows the meters to be controlled from a PC. Repeated interval measurements can be conducted for a specified number of times at specified intervals, measurement data can be displayed on graphs or lists, and data can be sent to spreadsheet applications.

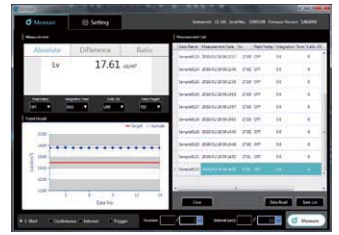

Supported OS :

Windows® 7 Professional 32bit, 64bit

Windows® 8.1 Pro 32bit, 64bit

Windows® 10 Pro 32bit, 64bit

Main applications



Main Specifications

Model	LS-150	LS-160
Measuring angle	1°	1 / 3°
Optical system	SLR viewing system, f = 85 mm F2.8	
Angle of view	9° (with diopter adjustment)	
Relative spectral responsivity	Closely matches spectral luminous efficiency (V (λ))	
Applicable standard	DIN 5032-7 Class B compliant	(N/A)
Minimum measuring area (diameter)	14.4 mm (1.3 mm when close-up lens is used)	4.5 mm (0.4 mm when close-up lens is used)
Minimum measuring distance (From the measuring distance reference plane)	1,012 mm (213 mm when close-up lens is used)	
Measurement mode	Instantaneous value, maximum/minimum value, luminance difference (Δ)/luminance ratio (%)	
Measurement time	AUTO: 0.7 to 4.3 seconds Manual: 0.7 to 7.1 seconds	
Luminance unit	cd/m ² or fL	
Luminance range	0.001 to 999,900 cd/m ²	0.01 to 9,999,000 cd/m ²
Accuracy*1	±2% ± 2 digits (1 cd/m ² or less) ±2% ± 1 digit (1 cd/m ² or more)	±2% ± 2 digits (10 cd/m ² or less) ±2% ± 1 digit (10 cd/m ² or more)
Repeatability*1	0.2% + 1 digit	
Calibration standard	Konica Minolta standard/user-specified standard switchable	
User calibration channels	10 channels	
Data memory	1,000 data	
External display (Number of significant digits)	4 digits (Max.)	
Internal display (Number of significant digits)	4 digits (Max.)	
Interface	USB2.0	
Power	AA-size batteries (x2), USB bus power, or optional AC adapter	
Current consumption	When viewfinder display is lit: 70 mA average	
Operation temperature/humidity range	0 to 40°C, relative humidity of 85% or less (at 35°C)	
Storage temperature/humidity range	0 to 45°C, relative humidity of 85% or less (at 35°C)	
Size	71×214×154 mm	
Weight	850 g (without batteries)	
Standard accessories	Lens Cap, Eyepiece ND Filter Eyepiece Cap, AA-size batteries (x2) Hard Case CS-A12, Wrist Strap CS-A13 USB Cable T-A15, Data Management Software CS-S20	
Optional accessories	Close-Up Lens No. 153/135/122/110 CCD Camera Adapter CS-A14 Illuminance Adapter CS-A15 AC Adapter AC-A305J/L/M	

*1 Standard Illuminant A; Standard measurement distance; Measurement time setting: Auto

System Diagram

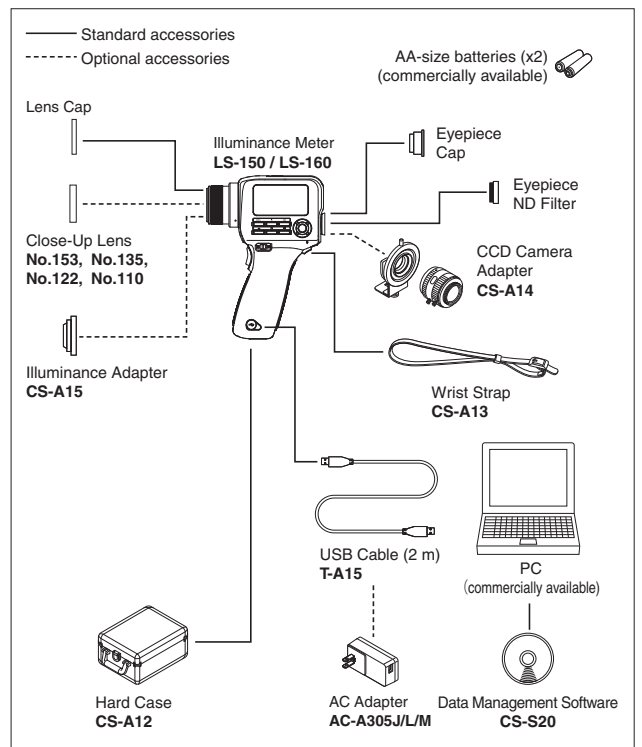

Dimensions (Units:mm)

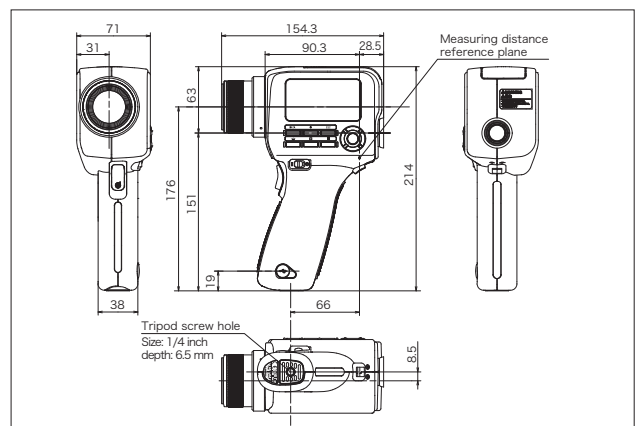

Chroma Meter CS-150/CS-160

New models with higher accuracy and comfort of use!



Chroma Meter CS-150

Chroma Meter CS-150 measures color and luminance with 1° measuring angle across a 0.01 to 999,900 cd/m² range.

Chroma Meter CS-160

Chroma Meter CS-160 measures color and luminance with 1/3° measuring angle across a 0.1 to 9,999,000 cd/m² range.

Main Features

High accuracy

The CS-150 and CS-160 are highly accurate tristimulus colorimeters equipped with newly designed sensors with spectral responses that more closely match the CIE 1931 color-matching functions representing the sensitivity of the human eye to provide measurement results that better correlate with visual evaluation.

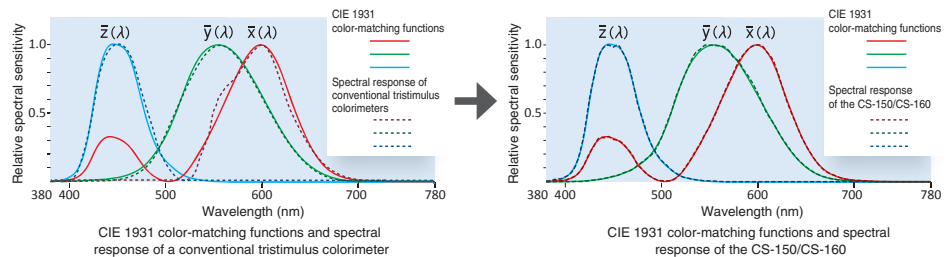

* The $\bar{x}(\lambda)$ CIE 1931 color-matching function has two peaks, a small one in the short-wavelength region (often labeled $\bar{x}1(\lambda)$) and a larger one in the long-wavelength region (often labeled $\bar{x}2(\lambda)$). In conventional tristimulus colorimeters, the $\bar{x}(\lambda)$ sensor has a spectral response only for the long-wavelength region $\bar{x}2(\lambda)$, and the data for the short-wavelength region $\bar{x}1(\lambda)$ is calculated from the $\bar{z}(\lambda)$ sensor. But the CS-150 and CS-160 have spectral responses that more closely follows the CIE 1931 color-matching functions, and directly measures using the $\bar{x}(\lambda)$ response in both the short-wavelength region $\bar{x}1(\lambda)$ and long-wavelength region $\bar{x}2(\lambda)$, so the resulting instrument spectral response more closely matches the CIE 1931 color-matching functions for the human eye.

Incredibly easy to use

- Automatic mode automatically sets the measurement time according to the brightness of the target.
- Bright viewfinder makes it easy to target desired areas of measurement subjects.
- Backlit display is easy to read even in dark places, and is automatically switched off during measurements.
- Easy-to-hold grip. Smooth focusing during measurement.

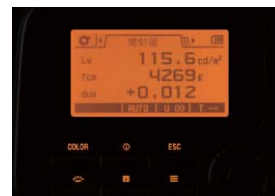
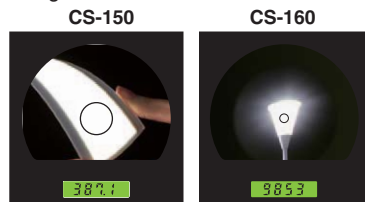

Numerous optional accessories

Close-up lenses

Lineup of 4 lenses (Nos. 153, 135, 122, and 110) enable measurements of tiny areas.



Measuring distance and measuring area (Units:mm)

(Measuring angle)	Minimum measuring area		Maximum measuring area		Minimum measuring distance	Maximum measuring distance
	1/3°	1°	1/3°	1°		
None	4.5	14.4	∞	∞	1,012	∞
No.153	2.5	8	5.9	18.8	627	1,219
No.135	1.6	5.2	2.7	8.6	455	625
No.122	1.0	3.2	1.3	4.3	331	378
No.110	0.4	1.3	0.5	1.5	213	215

*Measuring distance is the distance from the measuring distance reference plane.

C-mount CCD camera adapter enables the viewfinder to be monitored from a distance.

This adapter allows an industrial C-mount CCD camera to be attached to the viewfinder so that measurements including the view through the viewfinder can be monitored from a distance or recorded.

* CCD camera not included.



Illuminance adapter enables illuminance to also be measured.



Measurable illuminance range:

CS-150: Corresponds to 0.15 - 999,900 lx

CS-160: Corresponds to 1.5 - 9,999,000 lx

* This illuminance measuring method does not conform to DIN or JIS standards.

Easy-to-understand utility software

The included software allows the meters to be controlled from a PC. Repeated interval measurements can be conducted for a specified number of times at specified intervals, measurement data can be displayed on graphs or lists, and data can be sent to spreadsheet applications.

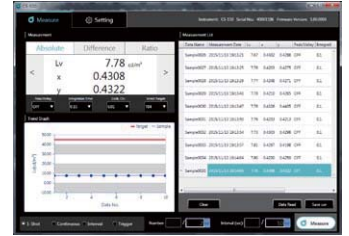

Supported OS :

Windows® 7 Professional 32bit, 64bit

Windows® 8.1 Pro 32bit, 64bit

Windows® 10 Pro 32bit, 64bit

Main applications



Main Specifications

Model	CS-150	CS-160
Measuring angle	1°	1/3°
Optical system	SLR viewing system, f = 85 mm F2.8	
Angle of view	9° (with diopter adjustment)	
Relative spectral responsivity	Closely matches CIE 1931 color matching function ($\bar{x}(\lambda)$, $\bar{y}(\lambda)$, $\bar{z}(\lambda)$)	
Minimum measuring area (diameter)	14.4 mm (1.3 mm when close-up lens is used)	4.5 mm (0.4 mm when close-up lens is used)
Minimum measuring distance (From the measuring distance reference plane)	1,012 mm (213 mm when close-up lens is used)	
Color notations	(Absolute value) L_v , x , y (Y , x , y), L_v , u' , v' , L_v , T_{cp} , duv , XYZ, L_v , $\lambda\lambda_d$, P_e	
Measurement mode	(Luminance) Instantaneous value, maximum/minimum value, luminance difference (Δ)/luminance ratio (%) (Chromaticity) Instantaneous value, chromaticity difference (Δ)	
Measurement time	Auto: 0.7 to 4.3 seconds Manual: 0.7 to 7.1 seconds	
Luminance unit	cd/m ² or fL	
Luminance range	0.01 to 999,900 cd/m ²	0.1 to 9,999,000 cd/m ²
Accuracy*1	(Luminance) $\pm 2\% \pm 1$ digit (Chromaticity) ± 0.004 (50 cd/m ² or more)	(Luminance) $\pm 2\% \pm 1$ digit (Chromaticity) ± 0.004 (50 cd/m ² or more)
Repeatability*1	(Luminance) 0.2% + 1 digit (Chromaticity) 0.001 (100 cd/m ² or more) (Chromaticity) 0.002 (50 cd/m ² or more)	(Luminance) 0.2% + 1 digit (Chromaticity) 0.001 (100 cd/m ² or more) (Chromaticity) 0.002 (50 cd/m ² or more)
Calibration standard	Konica Minolta standard/user-specified standard switchable	
User calibration channels	10 channels	
Data memory	1,000 data	
External display (Number of significant digits)	(Luminance) 4 digits (Max.) (Chromaticity) 4 digits	
Internal display (Number of significant digits)	(Luminance) 4 digits (Max.)	
Interface	USB2.0	
Power	AA-size batteries (x2), USB bus power, or optional AC adapter	
Current consumption	When viewfinder display is lit: 70 mA average	
Operation temperature/humidity range	0 to 40°C, relative humidity of 85% or less (at 35°C)	
Storage temperature/humidity range	0 to 45°C, relative humidity of 85% or less (at 35°C)	
Size	71×214×154 mm	
Weight	850 g (without batteries)	
Standard accessories	Lens Cap, Eyepiece ND Filter Eyepiece Cap AA-size batteries (x2) Hard Case CS-A12 Wrist Strap CS-A13 USB Cable T-A15 Data Management Software CS-S20	
Optional accessories	Close-Up Lens No. 153/135/122/110 CCD Camera Adapter CS-A14 Illuminance Adapter CS-A15 White Calibration Plate (for 45-0) CS-A20 AC Adapter AC-A305J/L/M	

*1 Standard Illuminant A; Standard measurement distance; Measurement time setting: Auto

System Diagram

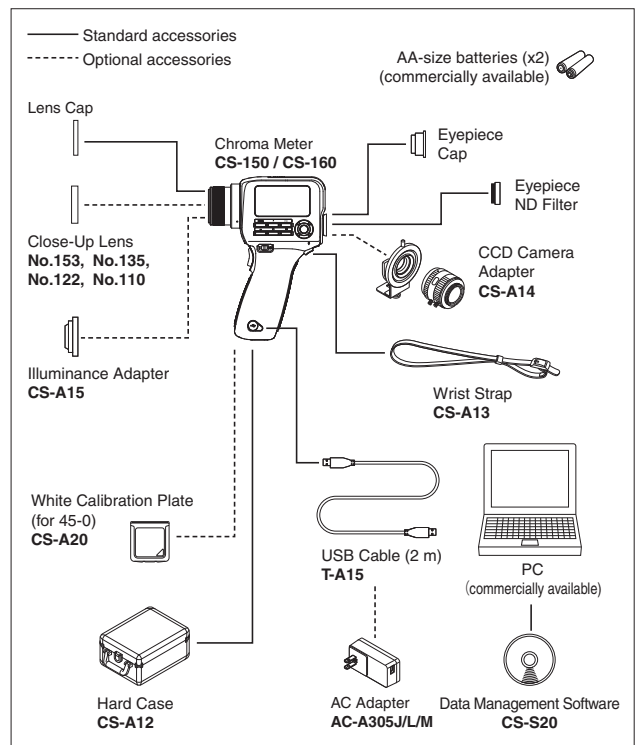

Dimensions (Units:mm)

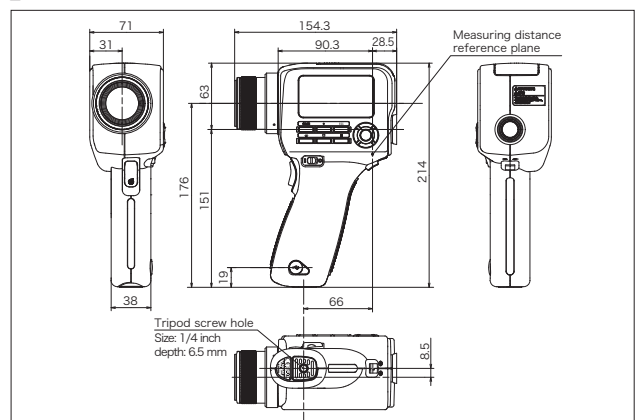

Chroma Meter CS-200

Accurate measurement Comparable to Spectroradiometers



Main Features

Perfect match of the spectral response to the CIE color-matching functions

Konica Minolta's newly-developed spectral fitting method provides tristimulus values (XYZ = red, green, blue) with significantly higher accuracy than that of conventional tristimulus colorimeters. This is achieved by using the output from 40 sensors to calculate the spectral response corresponding to human eye sensitivity (CIE 1931 color-matching functions). The CS-200 uses 40 sensors for sensitivity covering the entire visible region and multiplies each sensor output by appropriate coefficients. This adjusts the spectral response of the instrument to close to the CIE 1931 color-matching functions. In addition to the 2° Standard Observer, the 10° Standard Observer (for object-color measurements) can also be selected, which is impossible with conventional tristimulus colorimeters.

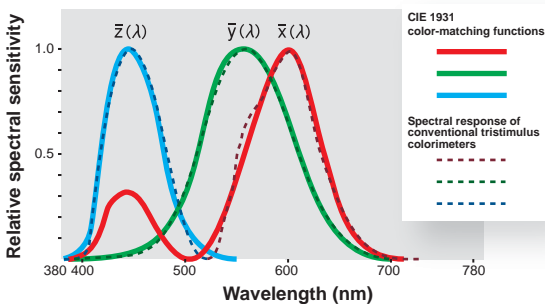

CIE 1931 color-matching functions and spectral response of a conventional tristimulus colorimeter

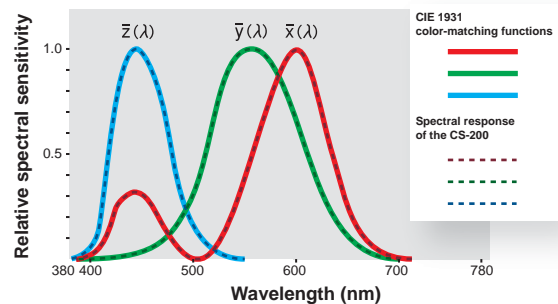

CIE 1931 color-matching functions and spectral response of the CS-200

Compact and lightweight. Battery power is also possible.

The compact, lightweight and stylish body allows hand-held operation. The CS-200 can be operated with either four AA batteries (battery indicator function provided) or a special AC adapter.

Selectable measuring angle

While checking the actual subject, you can select the measuring angle easily according to the application (1°, 0.2° and 0.1°). The aperture mirror eliminates misalignment between the finder target and the actual measuring spot, ensuring accurate aiming.

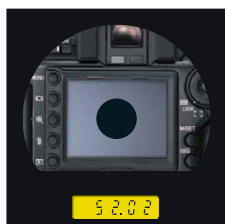

1° aperture
For measurement of general-size areas such as medium and large displays

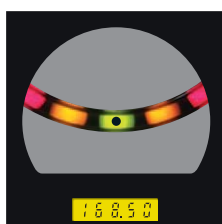

0.2° aperture
For measurement of small areas such as product LEDs

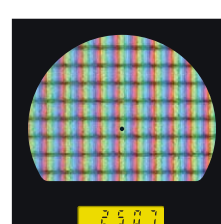

0.1° aperture
For measurement of very small areas or of a distant light source

Measuring distance and measuring area

(Unit: mm)

(Measuring angle)	Minimum measuring area			Maximum measuring area			Minimum measuring distance			Maximum measuring distance			Measuring area at 500 mm			Measuring area at 1000 mm		
	1°	0.2°	0.1°	1°	0.2°	0.1°	1°	0.2°	0.1°	1°	0.2°	0.1°	1°	0.2°	0.1°	1°	0.2°	0.1°
Without a Close-Up Lens	ø 4.7	ø 1.0	ø 0.5	∞	∞	∞	296			∞			ø 8.5	ø 1.7	ø 0.9	ø 17.7	ø 3.6	ø 1.8
Close-up lens No. 122	ø 2.2	ø 0.5	ø 0.3	ø 4.6	ø 1.0	ø 0.5	128			240			—	—	—	—	—	—
Close-up lens No. 107	ø 0.8	ø 0.2	ø 0.1	ø 1.1	ø 0.3	ø 0.2	43			52			—	—	—	—	—	—

* Measuring distance is the distance from the front edge of the metal lens barrel or close-up lens ring.

Data Management Software CS-S10w Standard (Standard accessory)

CS-S10w Standard Edition allows users to control the CS-200 with a PC to display the list of measured data or to transfer the data to spreadsheet software.

<Functions common to Standard and Professional Editions>

- Color space** : L_Vxy , $L_Vu'v'$, $L_VT\Delta uv$, XYZ, dominant wavelength
- Mode selection** : Normal mode
Object color mode
- Instrument control** : Average measurement
Interval measurement
User calibration

- Data management** : Reading and saving files
Data management with folders
- Data evaluation** : Observer/Illuminant settings
Statistics display for each folder
Box tolerance setting

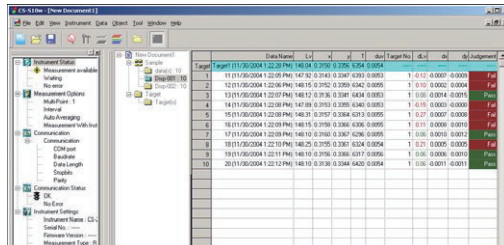

**List display
(Standard Edition)**

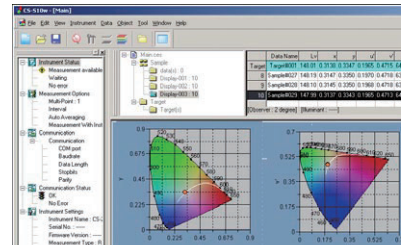

**xy and UV chromaticity diagrams
(Professional Edition)**

Specifications

Model	Chroma Meter CS-200		
Measurement range	0.01 - 200,000cd/m ²	(Measuring angle 1°)	
	0.01 - 5,000,000cd/m ²	(Measuring angle 0.2°)	
	0.01 - 20,000,000cd/m ²	(Measuring angle 0.1°)	
Accuracy (Measuring angle 1°) ^{*1} (Standard Illuminant A; Temperature: 23°C±2°C, Relative humidity: 65% max.)	150 cd/m ²	$L_V \pm 2\%$	$xy \pm 0.002$
	0.01-0.5 cd/m ²	$L_V \pm 0.02$ cd/m ²	---
	0.5-1 cd/m ²	$L_V \pm 0.02$ cd/m ²	$xy \pm 0.007$
	1-10 cd/m ²	$L_V \pm 2\%$	$xy \pm 0.004$
	10-200,000 cd/m ²	$L_V \pm 2\%$	$xy \pm 0.003$
Repeatability (Measuring angle 1°) ^{*2} (Standard Illuminant A)	0.01-1 cd/m ²	L_V 0.01 cd/m ²	---
	1-2 cd/m ²	L_V 0.5 %	xy 0.002
	2-4 cd/m ²	L_V 0.5 %	xy 0.001
	4-8 cd/m ²	L_V 0.5 %	xy 0.0005
	8-200,000 cd/m ²	L_V 0.1 %	xy 0.0004
Measurement time	AUTO	(Automatically set between approx. 1s and 60s)	
	LTD.AUTO	(Automatically set to approx. 1s or 3s)	
	Super-FAST	(approx. 0.5 sec/meas.) FAST (approx. 1 sec/meas.)	
Measurement method	Spectral method, Grating + linear photo diode array		
Measuring angle	1°, 0.2°, 0.1° (selectable)		
Minimum measuring area	0.5 mm		
Minimum measuring distance	0.1 mm (close up lens)		
Observer	2° or 10° Standard Observer		
Color space	L_Vxy , $L_Vu'v'$, $L_VT\Delta uv$, XYZ, dominant wavelength		
Measurement synchronization setting range	Vertical synchronization frequency : 40.00 to 200.00 Hz		
Interface	USB 1.1		
Power	AC Adapter or 4 AA-Size Batteries		
Battery performance	Approx. 3 hours (continuous measurement / Fast mode / AA-size alkaline cells)		
Size (W x H x D)	95 x 127 x 334 mm		
Weight	1.8 kg (without battery)		
Operation temperature/humidity range	0°C to 40°C, relative humidity 85% or less (at 35°C) with no condensation		
Storage temperature/humidity range	0°C to 45°C, relative humidity 85% or less (at 35°C) with no condensation		

*1 23°C ± 2°C $L_V = 0.01-10$ cd/m², SLOW, average of 30 measurements
 $L_V = 10$ cd/m² and higher, SLOW, average of 10 measurements

*2 At 0.2° measuring angle, the amount of received light is approx. 1/25 of that for 1°. Therefore, the repeatability becomes the same as that for 1° with 25 times lower luminance.
At 0.1° measuring angle, the amount of received light is approx. 1/100 of that for 1°. Therefore, the repeatability becomes the same as that for 1° with 100 times lower luminance.

System Diagram

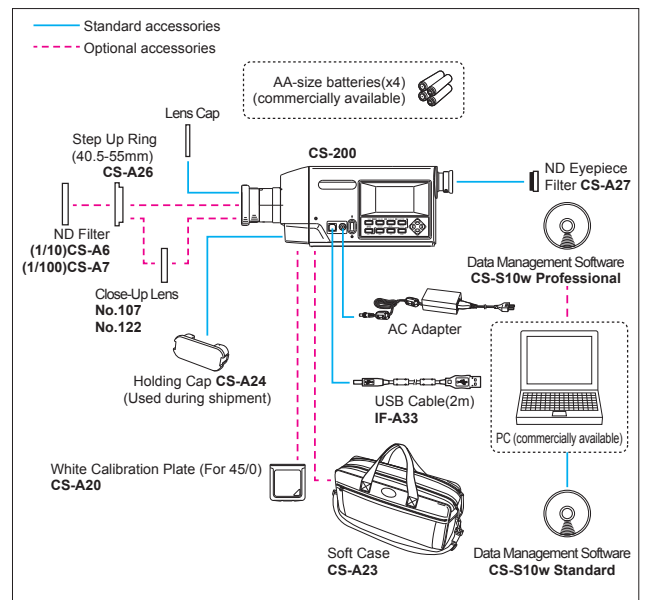

Dimensions (Units: mm)

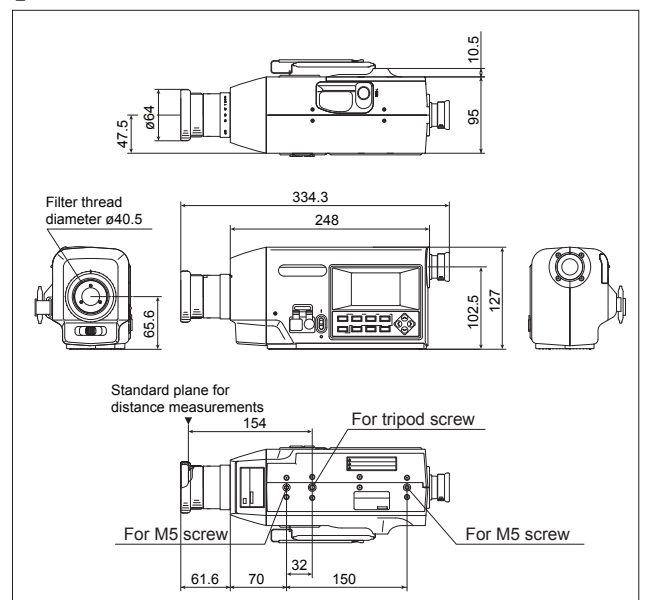

MEMO



KONICA MINOLTA

SAFETY PRECAUTIONS

For correct use and for your safety, be sure to read the instruction manual before using the instrument.



- Always connect the instrument to the specified power supply voltage. Improper connection may cause a fire or electric shock.
- Be sure to use the specified batteries. Using improper batteries may cause a fire or electric shock.

- KONICA MINOLTA, the Konica Minolta logo and symbol mark, and "Giving Shape to Ideas" are registered trademarks or trademarks of KONICA MINOLTA, INC.
- Windows® and Excel® are trademarks of Microsoft Corporation in the USA and other countries.
- Pentium® is a trademarks of Intel Corporation in the USA and other countries.
- The specifications and appearance shown herein are subject to change without notice.
- Some lighting control methods may make accurate measurements difficult. For details, please contact your nearest Konica Minolta sales office or dealer.



Certificate No : LRQ 0960094/A
Registration Date : March 3, 1995



Certificate No : JQA-E-80027
Registration Date : March 12, 1997

Your local distributor of Konica Minolta measuring instruments:

ThermoFisher
SCIENTIFIC

Australia: For customer service, call 1300-735-292
Visit us online at: www.thermofisher.com.au
New Zealand: For customer service, call 0800-933-966
Visit us online at: www.thermofisher.co.nz

For contact information in other countries, please refer to the KONICA MINOLTA Worldwide Offices web page: <https://www.konicaminolta.com/instruments/network>