

Reproducibility begins here

Milli-Q® IX 7003/05/10/15 Pure Water Systems

Reliably & reproducibly feed
your Type 2 pure water needs

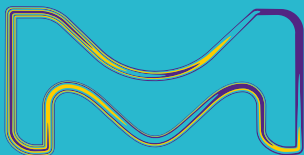

The life science business of Merck
operates as MilliporeSigma in the
U.S. and Canada.

Milli-Q®
Lab Water Solutions

Advance Your Purpose with the Milli-Q® IX pure water system.

Support for regulated environments*
where **compliance, accuracy & efficiency** are paramount



Needs of quality control & diagnostic labs	Milli-Q® IX pure water system
Adhere to industry requirements	<ul style="list-style-type: none"> Pure water quality meets Pharmacopeia and ISO® requirements
Reliable and repeatable results, avoiding false positives and false negatives	<ul style="list-style-type: none"> Constant, reliable pure water quality Continuous quality monitoring
High lab productivity & efficient use of resources	<ul style="list-style-type: none"> Easy to use and maintain
Secure data records & full traceability for audits	<ul style="list-style-type: none"> Automatic e-record archiving Simplified data management

* E.g. Food & beverage, environmental and industrial testing labs; clinical labs; pharma industry, etc.

Support for research & innovation environments*
to **discover and develop** the next big thing—faster



Needs of R&D labs	Milli-Q® IX pure water system
Remain focused on driving innovation	<ul style="list-style-type: none"> Easy to use and maintain Pure water always at hand with flexible dispensing
Secured data that's rapid to access	<ul style="list-style-type: none"> Automatic e-record archiving Integrated, simplified data management
Manage multiple users with varying needs	<ul style="list-style-type: none"> Filters and polishers adapt water quality to various requirements Robust for many users
Efficient use of budget & space	<ul style="list-style-type: none"> Cost-sharing features for shared use Compact with space-saving installation options

* E.g. Academia, research institutes, pharmaceutical research, biotech, etc.

Design that supports your sustainability initiatives.

Mercury-free UV technology | No hazardous waste
Reduced water & energy consumption

Feed Your Needs

From general laboratory use to your critical applications, the Milli-Q® IX system delivers constant pure water quality to meet your requirements.

Critical applications

- Microbiology culture media preparation
- Staining solutions for histology and cytology
- Immunohistochemistry (IHC)
- Gel electrophoresis, western blotting
- Immunoassays (ELISA, RIA)
- Dissolution testing
- Biological Oxygen Demand (BOD)/ Chemical Oxygen Demand (COD)
- UV/Vis Spectroscopy
- Titration

General laboratory applications

- Sample preparation (dilution, extraction, etc.)
- Buffer and reagent preparation
- Glassware rinsing

Equipment & instruments

- Autoclaves
- Dishwashers
- Weathering and stability test chambers
- Clinical analyzers and slide stainers
- Hydrogen generators
- Ultrapure water systems (e.g. Milli-Q® IQ 7000 system)



Because We Comply to Protect

Water Quality

With respect to daily, freshly produced water, the Milli-Q® IX system is intended to dispense pure water that meets or exceeds water quality specifications described by the organizations below:

Organization	Water quality/grade
European Pharmacopoeia	Purified water
U.S. Pharmacopeia	Purified Water
Japanese Pharmacopoeia	Purified Water
Chinese Pharmacopoeia	Purified Water
ASTM® D1193	Type 2 water - Reagent water
ISO® 3696	Grade 2 water
Chinese National Standard	GB 6682 Grade 2 water

The **Compliance Report** on Milli-Q® IX system conformity to industry norms is available upon request.

Keep Your Standards High

Because reliable results begin with consistent pure water quality.

With water as the basis of most reagents in the lab, its consistent purity is critical for achieving accurate and reliable results. For full confidence that water is not influencing your analyses, the Milli-Q® IX pure water system provides a reliable source of high-quality Type 2 pure water.

Innovation Inside

- Mercury-free $\text{ech}_2\text{o}^\circledR$ UV LED lamps*
- A redesigned and more intelligent pure water storage solution
- High-efficiency IPAK Gard® pre-treatment cartridge
- Seamlessly integrated tank vent filter

Intelligently protects against contamination

Because we know that bacterial contamination can wreak havoc on a lab's productivity, the Milli-Q® IX system takes the security of your pure water quality to the next level of care. See page 7 to learn how our uniquely designed **intelligent pure water storage solution** protects your water's purity better than ever before.

Improved sustainability through technology & design

We are committed to reducing the environmental impact of our products and supporting your efforts to identify more sustainable solutions. Jump to page 9 to discover innovative purification technologies and design features aimed to **minimize the environmental impact** of this system.

Carefree maintenance

We've made the Milli-Q® IX system easy to use and carefree to maintain so that your valuable resources can focus on what truly matters.

- **Automated self-upkeep features** (including RO flushing and rinsing, EDI rinsing, recirculation loop, and tank UV sanitization) make the IX system easy to maintain
- **Automated alerts** notify when consumables need replacing to avoid risk of impacting major components
- **Onscreen wizards** guide you to perform simple maintenance and troubleshooting procedures in-house
- **Twist & Lock** cartridge replacements can be confidently performed by anyone in the lab in a few minutes
- **Coordinated, once-a-year** consumable replacements minimize hassle



* Patent application pending

Simplify Everyone's Day

So easy & intuitive to use, it will boost your lab's daily efficiency.

Work more efficiently

Our advanced and ergonomic E-POD® point of dispense gives rapid and convenient access to pressurized pure water throughout your lab.

- **Twist, tap, or use no hands at all.** Twist the dispense wheel or tap the touchscreen to adjust flow rate or set the volume. Or, try the foot pedal option for hands-free filling.
- **Assure quality as you dispense.** Key quality parameters are in view and continuously monitored on the POD's touchscreen display.
- **Keep working** as Volumetric Dispense mode fills glassware to your set volume (1 ml increments from 20 mL to 99 L). Simply push the button, the screen or the foot pedal to repeat.
- **Set up convenient water stations** throughout your lab by connecting two E-POD® dispensers up to 5 m apart.



Effortless navigation, control and data management

The Milli-Q® IX system's touchscreen interface and data management capabilities will move your lab notebook and user manual to the digital age.

- **Interact with ease.** The smartphone-like touchscreen allows intuitive use, even with gloves on!
- **Goodbye user manual.** Onscreen, graphic instructions and maintenance wizards guide consumable changes and help manage alerts and alarms. But don't worry, a paper manual can still be downloaded from the system and printed.
- **Personalize views.** Program the interface that suits your lab's specific needs.
- **Digitalize your paper trail.** All water and system data are stored in system memory, avoiding manual entries in a logbook and increasing data quality, reliability and traceability.
- **Rapidly access data.** View data on screen, export it via the Ethernet connection or USB port on the dispenser, or email it to yourself using a report's QR code. All dispense attributes can be quickly retrieved to prepare an audit or for QC purposes.
- **Customize reports.** Create individual Dispense reports, determine average water quality over a time range, or even allocate costs for shared resources between labs and teams.



Purify for Purpose

Be confident that water quality is not influencing your experiments.

Complementary purification technologies remove contaminants to deliver consistently high-quality pure water directly from tap water.

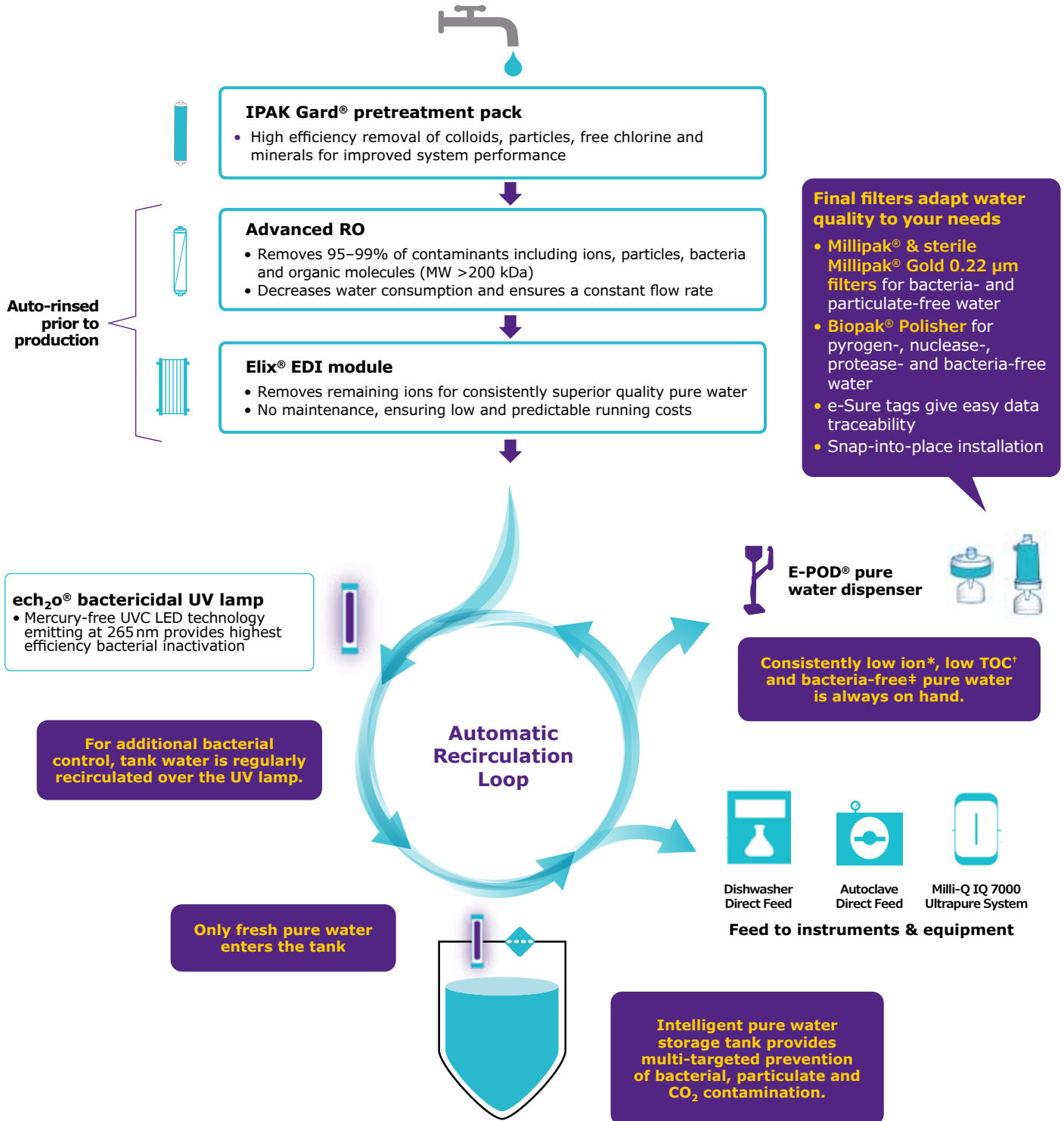

* Resistivity >5 MΩ·cm @ 25°C, typically 10-15 MΩ·cm; † TOC ≤30 ppb; ‡ Bacteria <0.01 cfu/mL with Millipak® or Millipak® Gold filters or Biopak® polisher when installed and used in a laminar flow hood; ASM, automatic sanitization module; EDI, electrodeionization; Hg, mercury; RO, reverse osmosis; TOC, total oxidizable carbon

Because Protection is Paramount

Discover our best-ever protection of stored pure water.

Introducing an intelligent storage solution, uniquely designed to safeguard water purity better than ever before.



25 L



50 L



100 L

Three tank sizes are available to ensure your lab's needs can be met today and tomorrow.

- **Prior to water production**, automatic rinsing of the RO membrane and the Elix® EDI module ensures that only the highest quality pure water enters the tank
- **Within the tank**, pure water quality is preserved by **3 built-in features**:
 - **Vent filter**, redesigned for seamless integration, provides improved protection against airborne contaminants
 - **Automatic Sanitization Module (ASM)** with an integrated mercury-free ech₂o® UVC LED lamp emitting at 265 nm, regularly irradiates stored water and tank walls, preventing bacterial growth and biofilm formation
 - **Overflow sensor** replaces the hydraulic overflow connection to a drain, eliminating this source of retro-contamination
- **Automatic recirculation of stored water** through a bactericidal UV lamp preserves water quality in the tank and ensures that high-quality Type 2 water is always on hand and ready to use

Innovative for Your Advantage

Advanced reverse osmosis (RO) reduces water consumption and associated costs

- Removes 95–99% of ions, and 99% of all dissolved large organics, microorganisms and particles
- RO recovery loop optimizes water recovery vs. standard RO systems and reduces water consumption
- Produces a constant product flow rate, regardless of feed water temperature or conductivity, enabling the system to adapt to your feed water
- Only high-quality water enters the Elix® EDI module

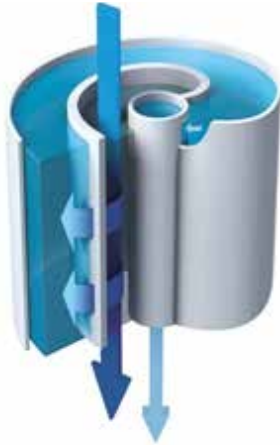

Flow-through view of an Advanced RO membrane, which is inserted into a cartridge. Tangential flow limits the risk of fouling.

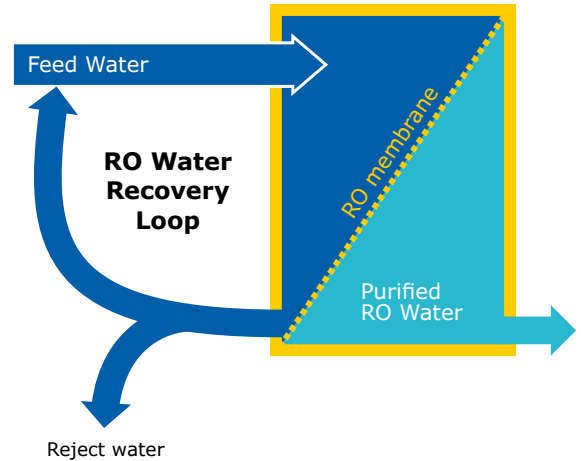

Elix® electrodeionization (EDI) module produces constant-quality pure water with no maintenance and at low and predictable running costs

- Our Elix® EDI module removes remaining ions to produce constant-quality pure water, regardless of feed water quality (conductivity, CO₂ levels) or RO cartridge performance
- Module continuously self-regenerates its ion-exchange resins via a small electrical field
- Eliminates the need for:
 - Hazardous chemical regeneration procedures
 - Replacement of costly resins
 - Changing DI cartridges
 - Adding softeners
- Reduces maintenance time and ensures low and predictable running costs

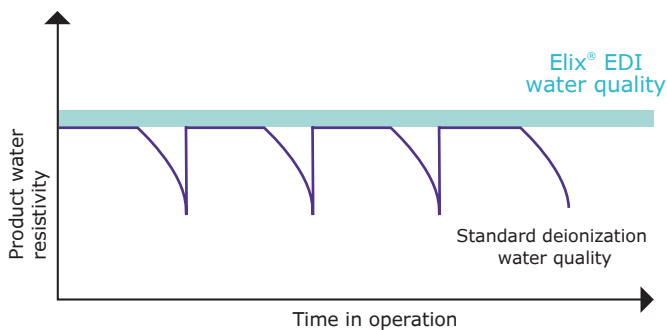

The graph shows the superiority of Elix® EDI technology over systems using ion-exchange resin packs. Resistivity drops dramatically when packs are exhausted.

*When CO₂ dissolved in feed water is less than 30 ppm.

Elix® module

Our unique technology is based on anion- and cation-permeable membranes, high-quality ion-exchange resin and activated carbon beads, placed in an electric field. Water produced by the Elix® module enters the tank with resistivity greater than 5 MΩ·cm at 25°C (typically up to 15 MΩ·cm at 25°C).^{*} Ion exchange resins are constantly regenerated by the electric field, without any chemicals needed.

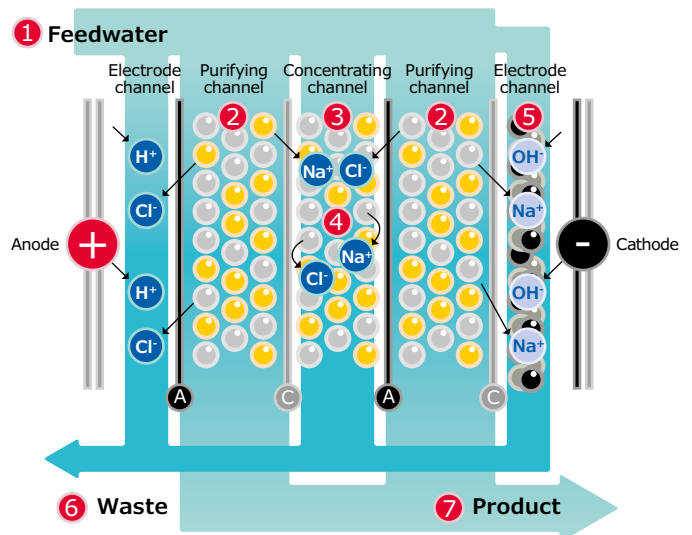

- Ⓐ Anion-permeable membrane
- Ⓒ Cation-permeable membrane
- Elix® technology purification steps

Supports Your Sustainability Initiatives

Reduced water & energy consumption

- By recycling reject water, Advanced RO optimizes water recovery, thus reducing water waste and overall water consumption
- Unique *Lab Close* mode minimizes water and energy consumption when your lab is closed for long weekends and holidays. The system automatically switches back to normal before your return, ensuring you have water ready for use.

Mercury-free UV LED lamps

- Mercury-free ech_2o ® bactericidal lamps thanks to UVC LED technology emitting at 265 nm for highest efficiency bacterial inactivation.
- A more compact lamp size contributes to a smaller system footprint.

No hazardous chemicals

Elix® EDI applies a weak electrical current to regenerate resin. This eliminates the need for chemical regeneration, avoiding chemical waste and associated waste shipment and disposal fees.

(More information on page 8)

Less plastic that is more sustainable

More than 20% of our plastic suppliers are compliant with the **Together for Sustainability** initiative, an initiative that pushes for better sustainability practices in materials and supply chain sourcing. These suppliers provide more than 50% of the plastics in our system.

We have worked hard to reduce the size of the system, tank and consumables so that less plastic is used in manufacturing, packaging and shipping.

- Milli-Q® IX system footprint is 15-30% smaller vs. prior Elix® Advantage system.
- New tanks are more compact with vent filter integrated on top, to give an easier fit in limited space.
- IPAK Gard® purification cartridge is smaller than former pre-treatment cartridges.

Paperless data management

- MyMilli-Q™ cloud-based digital service stores all documentation (e.g., service reports, user manuals) and enables online contract management.
- Relevant certificates and a quick reference guide are supplied in system memory and on a USB key.
- The complete and comprehensive user manual can be downloaded from the POD screen.
- An Ethernet port enables direct downloads to PCs on the same network.



We have also worked to develop technologies that extend the lifetime of system consumables, minimizing waste:

- Advanced RO extends pretreatment cartridge lifetime.
- Consumables have longer lifetimes vs. previous generation (1 year vs. 6 months).



Fit Your Space

Versatile configurations give the best set up for your lab

The Milli-Q® system is designed for easy integration so you can optimize valuable lab space.

Choose to wall mount both the system and tank, store them under the bench (25 and 50 L tanks), or a combination to suit your space requirements. Units can be tucked into a corner, high up on a wall, or installed at a distance in a cabinet. There's no need to install near a sink and the tank does not require a drain.

Only the E-POD® dispensers remain on the bench, up to 5 m from the system. Two dispensers can be supplied by one purification unit, with an allowance of up to 5 m between the PODs. This way, scientists at distant benches—or even another lab—have access to purified water.

Cabling is available in customizable lengths and enclosed in protective sheathing for a neat, uncluttered installation.

A range of convenient installation options

The Milli-Q® IX 7003/05/10/15 system is designed for easy integration almost anywhere in your lab. The optimal configuration will be defined with you to maximize your lab's space and bring water to where it's the most convenient for your usage.

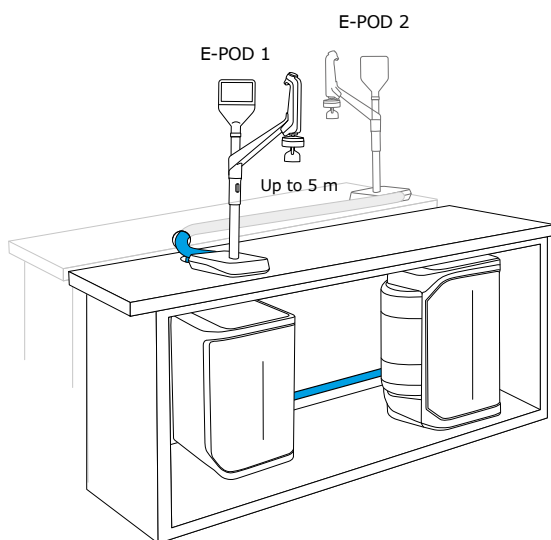

Two dispensers can be connected

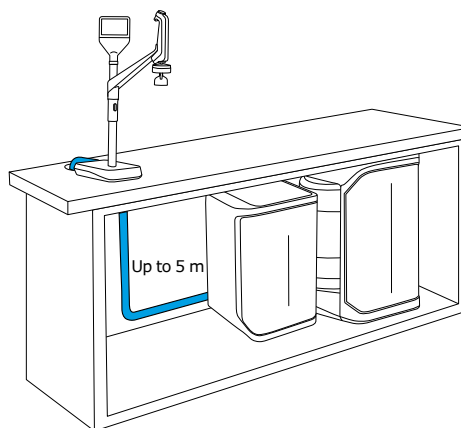

Under-bench installation

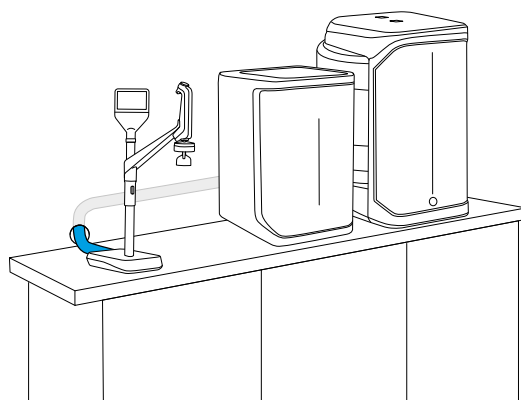

Bench-top installation

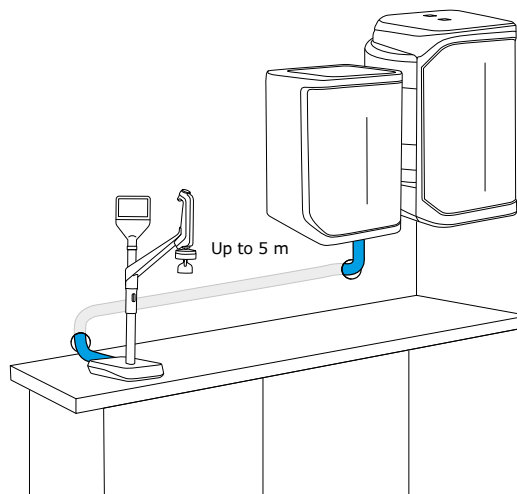

Wall-mounted installation

Adapt to Your Requirements

We offer a range of accessories to support your specific needs and environment.

Choose from the following options:

- **Foot pedal** for hands-free water delivery
- **Sanitary sampling valve** provides safe and reliable water sampling to facilitate microbiological analysis
- **Water sensors** detect water on the floor and automatically close the stand-alone inlet solenoid valve to protect the lab from water damage
- **Washer distribution kit** dispenses pressurized water directly from the tank to dishwasher
- **External solenoid valve** stops feedwater at the source in case a leak is detected to help prevent flooding
- **Installation solutions** to wall-mount the system and/or tank

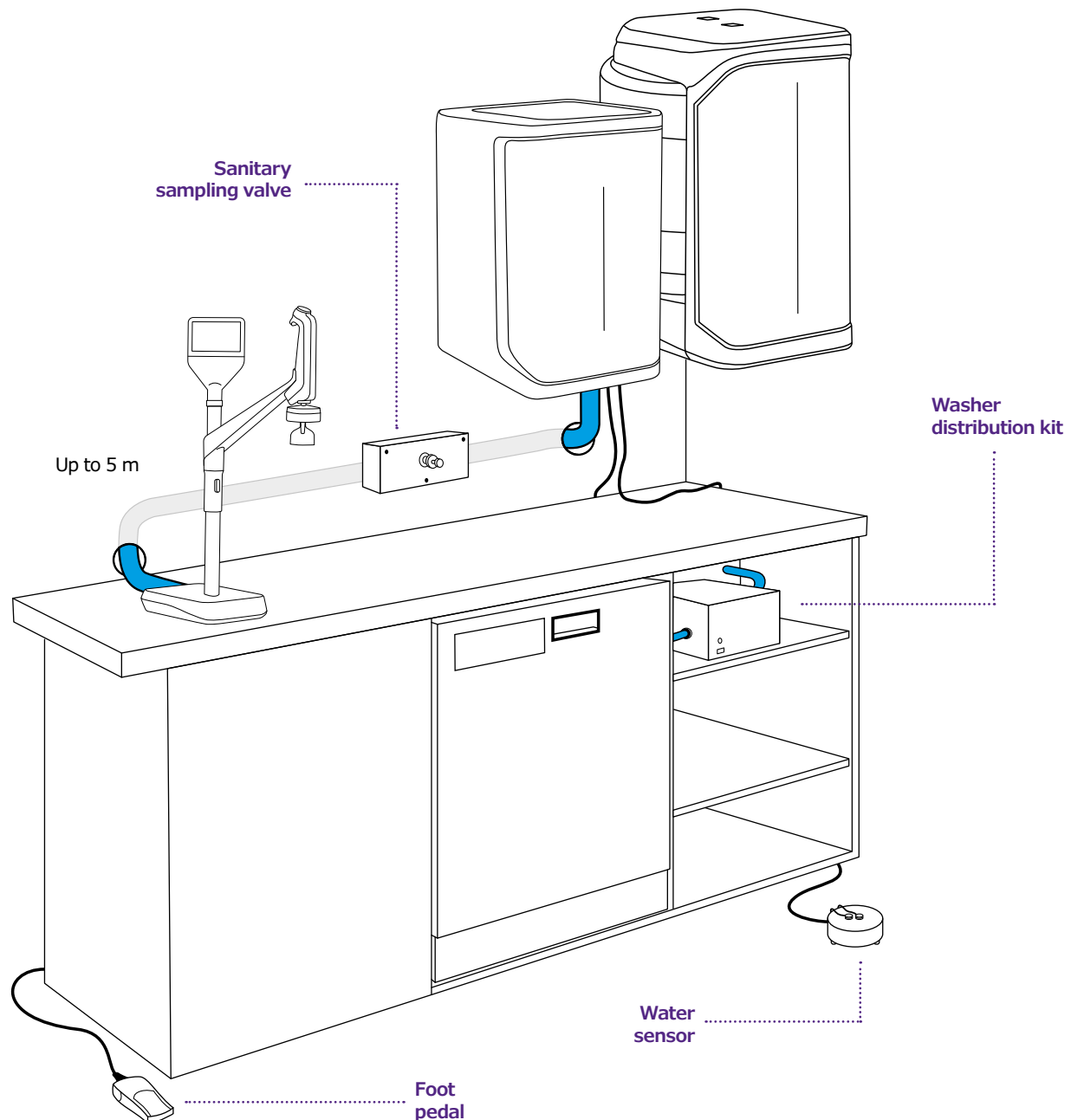

Trust in Best-in-Class Milli-Q® Services

And discover MyMilli-Q™ digital services.

From installation and training to yearly check-ups, qualification procedures, and our time-saving digital solutions, with Milli-Q® Services, you receive best-in-class service and support from the people who designed and built your system.

Quality certified & globally harmonized expertise

- Only Milli-Q®-certified field service engineers install, maintain and repair our water purification systems
- Genuine parts from our ISO 9001-certified manufacturing site
- In compliance with our worldwide auditable Standard Operating Procedures
- Standardized visit reports and traceable records of care

Installation & user training

Our highly trained engineers provide an efficient system installation service, supplying all components required. You will receive user training and advice on how to use your system.

Validation & qualification expertise

For regulated environments, our full Qualification Program supports laboratory validation procedures. Our engineers have a complete set of qualified tools and specific test equipment developed for our systems. They will help you to successfully carry out your Installation Qualification (IQ), Operational Qualification (OQ) and Maintenance procedures (MP), and provide examples of Performance Qualification (PQ) files.

Milli-Q® Service Plans & support options to meet any lab's needs

To ensure your Milli-Q® system continuously operates at optimum efficiency, we provide a range of service plans and options that can be tailored to suit your application, compliance and budgetary requirements. All Milli-Q® Service Plans include an annual preventive maintenance visit from one of our engineers and access to our cloud-based digital service portal, MyMilli-Q™ online solution.

Milli-Q® digital services

Now, you can log into **MyMilli-Q™ online solution** to streamline the care of your Milli-Q® systems:

- Track service history & reports
- Manage consumable deliveries
- Plan maintenance visits
- Renew service contracts

Discover more:
SigmaAldrich.com/Milli-QServices



Technical Appendix

Milli-Q® IX 7003/05/10/15 water purification systems





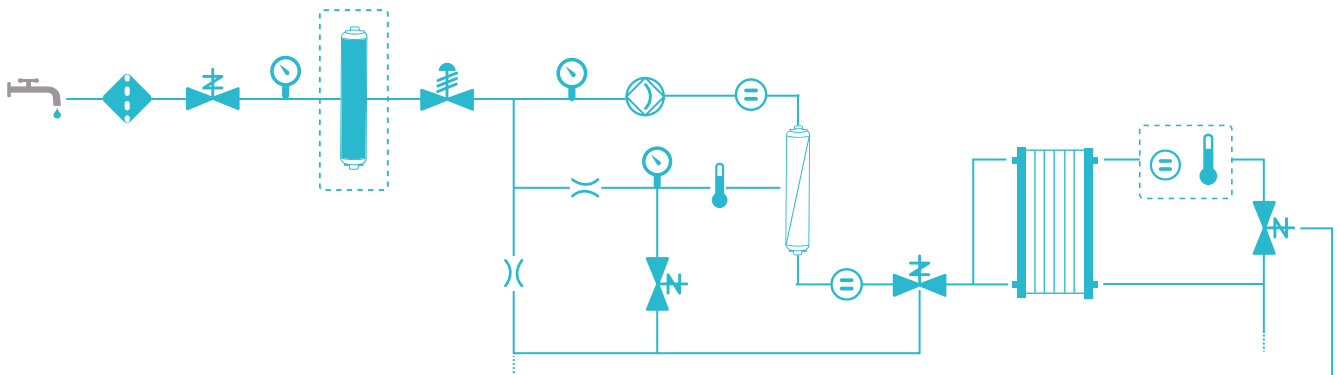



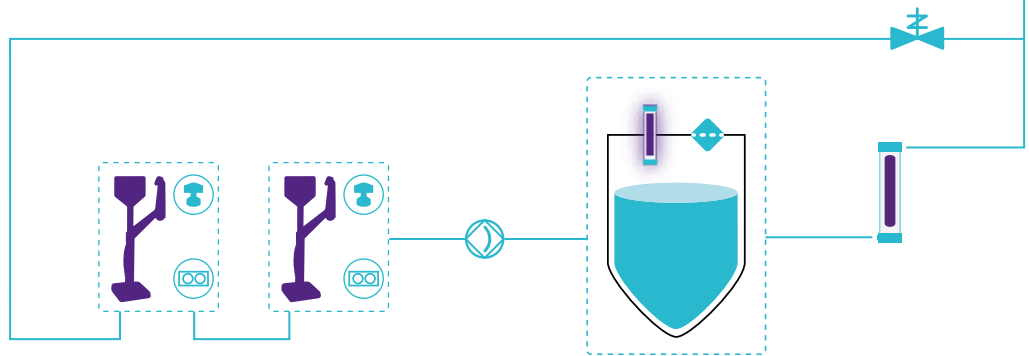









Milli-Q® IX systems use regular tap water as feed to produce pure (Type 2) water. A pure water storage tank feeds the distribution loop to deliver water to independent E-POD® dispensers (maximum two) and other connected laboratory equipment (e.g. dishwasher, ultrapure water system, etc.).

Production flow schematic



Distribution flow schematic



- | | | | |
|--|--|--|--|
|  Tap feed water |  IPAK Gard cartridge |  RO membrane |  Elix EDI module |
|  ech ₂ o UV lamp |  Storage tank (25/50/100 L) |  Vent filter |  ech ₂ o ASM UV lamp |
|  Strainer filter |  E-POD dispenser |  Millipak/Biopak final filter |  Pump |
|  Conductivity cell |  Solenoid valve |  Pressure sensor |  Resistivity cell |
|  Thermistor |  Flow controller | | |

Purification unit and storage tank specifications

Purification unit

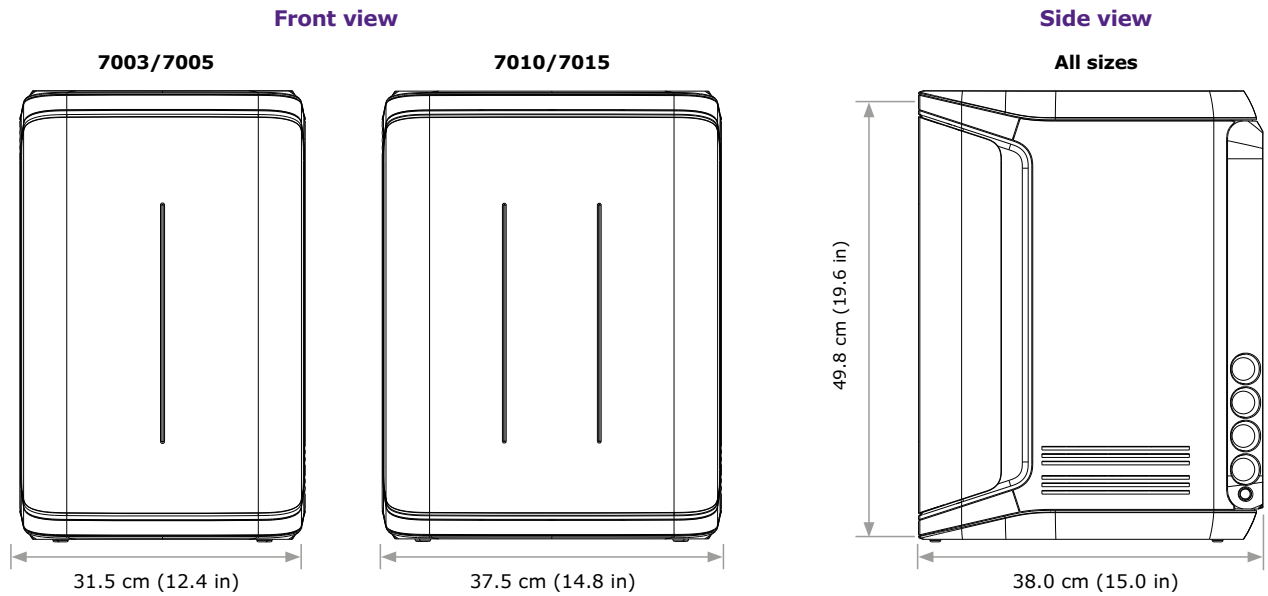

Storage tank

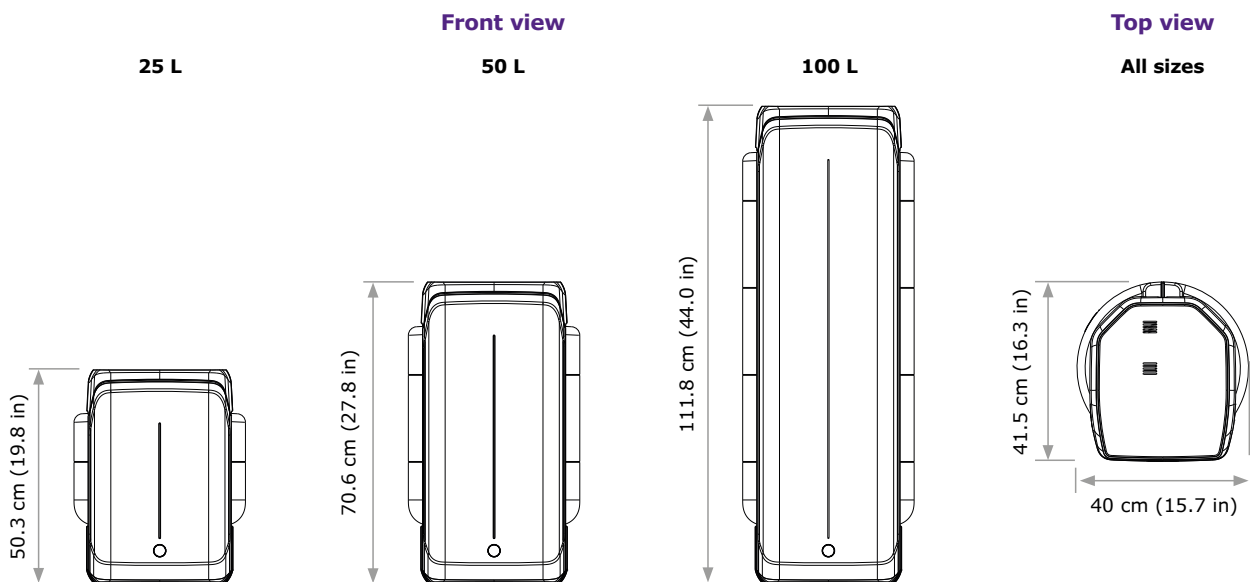

Tubing and port requirements

Item	Description
Feed water connection	½" Gaz
Distance from feed water port	Maximum 5 m (16.4 ft)
Distance from purification unit to E-POD® dispenser	Maximum 5 m (16.4 ft)
Distance from purification unit to tank	Maximum 5 m (16.4 ft)
Power entry	Connection IEC 13
ON/OFF switch	Available on the unit
Water sensor port	Maximum 3.3 VDC
Tank level adapter port	Maximum 5 VDC
Ethernet port	IEEE P802.3

Electrical connections and specifications

Item	Description
Power source voltage	100–240 VAC ± 10%
Power frequency	50–60 Hz ± 2 Hz
Power used	Maximum 350 VA
Power cord length	2.5 m (8.2 ft) plug: IEC13 female
Operational temperature	4–40 °C (39–104 F)
Altitude	Up to 3000 m (9842 ft)
Tank material	High purity polyethylene

Weights

Milli-Q® IX system type		Dry weight	Shipping weight	Operating weight
Purification unit	7003/7005	19.5 kg (43.1 lb)	22.5 kg (49.7 lb)	23.4 kg (51.6 lb)
	7010	22.2 kg (49.0 lb)	25.4 kg (56.1 lb)	27.1 kg (59.8 lb)
	7015	22.5 kg (49.7 lb)	25.7 kg (56.7 lb)	27.4 kg (60.5 lb)
Storage tank	25 L	6.7 kg (14.8 lb)	8.5 kg (18.7 lb)	31.7 kg (69.9 lb)
	50 L	7.6 kg (16.8 lb)	10.6 kg (23.4 lb)	57.6 kg (127.0 lb)
	100 L	10.9 kg (24.0 lb)	12.8 kg (28.2 lb)	110.9 kg (244.5 lb)

E-POD® dispenser specifications

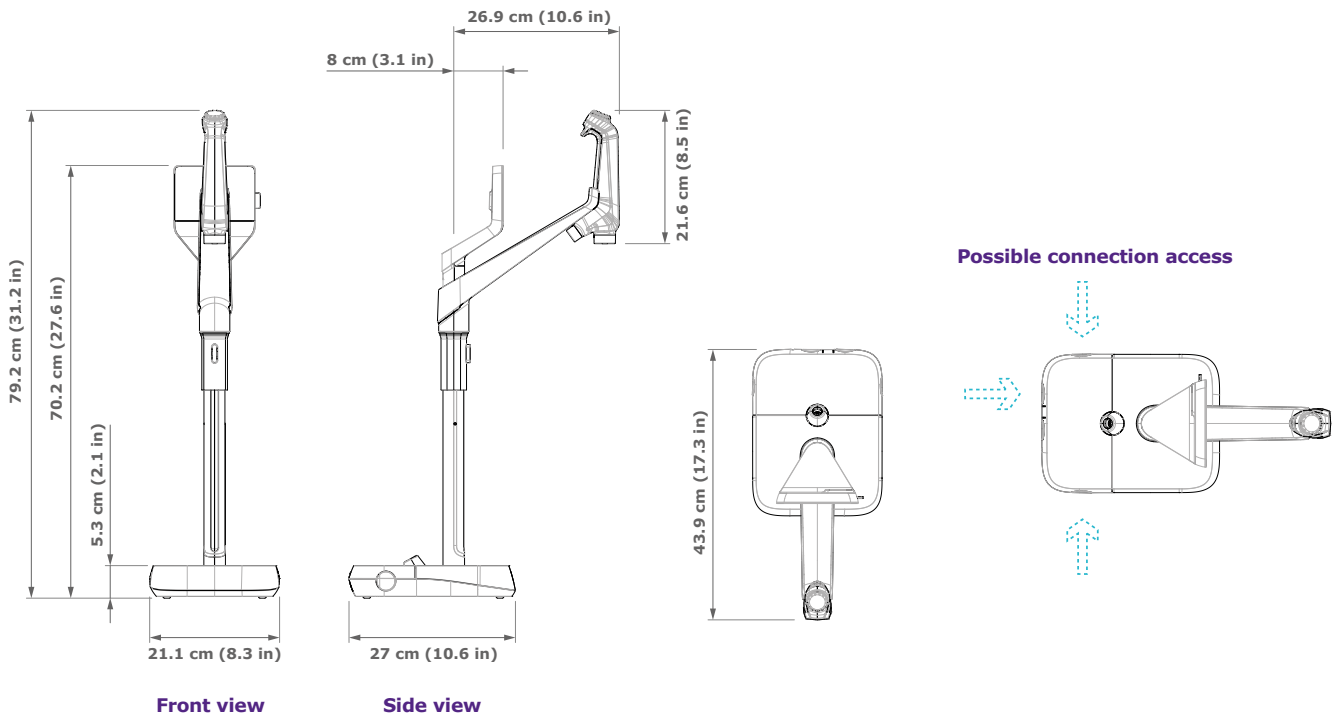

Tube and port requirements

Parameter	Description
Dispenser tubing length	0.92 m (36.22 in)
Distance from purification unit to POD dispenser	Maximum 5 m (16.4 ft)
Distance between two POD dispensers (Maximum 2 dispensers connected in series)	Maximum 5 m (16.4 ft)
POD dispenser data connection with unit	Ethernet
Electrical connection	Powered by purification unit (24–28 VDC)
Foot pedal port	3.3 V

Weights

	Dry weight	Shipping weight	Operating weight
E-POD®	4.7 kg (10.4 lb)	7.2 kg (15.9 lb)	5.5 kg (12.1 lb)

Screen description and functionalities

Parameter	Description
Capacitive touchscreen	Size: 5 in; Resolution: 800 x 480
USB port	USB 2.0 Highspeed standard
Speaker	Impedance: 8 Ω/max output power: 0.5 W
Display in 9 languages	Chinese/English/French/German/Italian/Japanese/Portuguese/Russian/Spanish

Water specifications

Feed water requirements

Feed water	Potable tap water
Pressure	1–6 bar
Temperature	5–35 °C (41–95 F)
Conductivity	<2000 µS/cm at 25 °C
Dissolved CO ₂	<30 ppm
Free chlorine	<3 ppm
Fouling Index	<10
pH	4–10
Total Organic Carbon (TOC)	<2 ppm
Langlier Saturation Index (LSI)	<0.3
Hardness (as CaCO ₃)	<300 ppm
Silica	<30 ppm

Pure, Type 2 water specifications¹

Resistivity at 25 °C ²	>5 MΩ·cm; typically 10–15 MΩ·cm
Conductivity at 25 °C	<0.2 µS/cm; typically 0.1 µS/cm
TOC	≤30 ppb
Production flow rate	3 L/h (Milli-Q® IX 7003) 5 L/h (Milli-Q® IX 7005) 10 L/h (Milli-Q® IX 7010) 15 L/h (Milli-Q® IX 7015)

From an E-POD® dispenser with final filter, the following water quality specifications are achieved:¹

Particulates ³	No particles with size >0.22 µm
Bacteria ⁴	≤10 cfu/L
Pyrogens (endotoxins) ⁵	<0.001 EU/mL
RNases ⁶	<1 pg/mL
DNases ⁶	<5 pg/mL
Proteases ⁶	<0.15 µg/mL
Flow rate	Up to 2 L/min

1. These values are typical and may vary depending on the nature and concentration of contaminants in the feed water.

2. Resistivity can also be displayed non-temperature-compensated as required by USP.

3. With Millipak® or Millipak® Gold filter.

4. With Millipak® or Millipak® Gold filters or Biopak® polisher when installed and used in a laminar flow hood.

5. With Biopak® polisher when installed and used in a laminar flow hood.

6. With Biopak® polisher.

International regulatory requirements

EU declaration of conformity – UL safety marking

The Milli-Q® IX 7003/05/10/15 system has been designed and manufactured in accordance to the international standard and test method defined by the IECCE organization according CB Scheme process. CB Scheme process was applied for electromagnetic compatibility and safety compliance.

The Milli-Q® IX 7003/05/10/15 system is also subject of the UL listing Marking Program and meets the following marking and registration requirements listed below:

- UL registration can be verified on the UL website: www.ul.com
- Access to CB certificate: <http://members.iecee.org/>

We also meet the regulatory requirements of the following organizations:

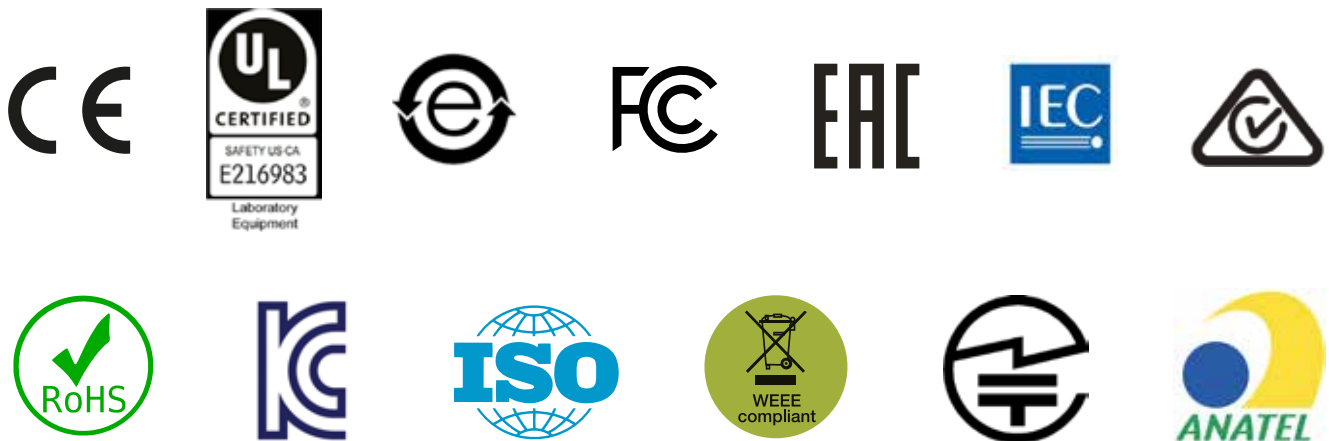

Ordering information

System components	Catalog number
Milli-Q® IX 7003 Water Purification System	ZIX7003T0
Milli-Q® IX 7005 Water Purification System	ZIX7005T0
Milli-Q® IX 7010 Water Purification System	ZIX7010T0
Milli-Q® IX 7015 Water Purification System	ZIX7015T0
E-POD® Remote Dispenser	ZIQEP0D00
Milli-Q® IQ Storage Tanks Frame 25 L	TANKA025
Milli-Q® IQ Storage Tanks Frame 50 L	TANKA050
Milli-Q® IQ Storage Tanks Frame 100 L	TANKA100
Milli-Q® IQ Storage Tank Top Assembly	TANKT0PA1

Purification kits & Application POD-Paks	Catalog number
Milli-Q® IX 7003-5 purification kit (pre-treatment & vent filter)	IX700XPKT1
Milli-Q® IX 7003-5 purification kit H (HW pretreatment & vent filter)	IX700XPKT1H
Milli-Q® IX 7010-15 purification kit (pre-treatment & vent filter)	IX70XXPKT1
Milli-Q® IX 7010-15 purification kit H (HW pretreatment & vent filter)	IX70XXPKT1H
Vent Filter HF (for high-flow applications)*	TANKVH1A1
Millipak® 0.22 µm filter	MPGP002A1
Millipak® Gold 0.22 µm sterile filter	MPGPG02A1
Biopak® polisher	CDUFBI0A1

Accessories	Catalog number
Sanitary valve kit	ZIQ7ESP01
System wall mounting bracket	SYSTFIXA1
E-POD® wall mounting bracket	WMBQP0D01
Tank wall mounting bracket	TANKFIXA1
Foot pedal	ZMQSFTSA1
Water sensor	ZWATSENA1
External solenoid valve for feed water	EXTSV00A1
Connector 2 m system-to-POD	ZFC0NN2SQ
Connector 5 m system-to-POD	ZFC0NN5SQ
Connector 2 m system-to-tank	ZFC0NN2ST
Connector 5 m system-to-tank	ZFC0NN5ST
Connector 2 m POD-to-POD	ZFC0NN2QQ
Connector 5 m POD-to-POD	ZFC0NN5QQ

System care	Catalog number
ROCare A - Acidic care	ZWACID012
ROCare B - Basic care	ZWBASE012
ROProtect C - Chlorine tablets	ZWCL01F50
EfferSan Effervescent Tablets (USA)	5874316024
EfferSan Effervescent Tablets (CAN)	5874316024C

* For flow rate >16.5 LPM.

Milli-Q®

Lab Water Solutions

Authorised distributor

In Australia:

For customer service, call 1300-735-292

To fax an order, use 1800-067-639

To email an order, ordersau@thermofisher.com

In New Zealand:

For customer service, call 0800-933-966

To fax an order, use 0800-329-246

To email an order, ordersnz@thermofisher.com

ThermoFisher
SCIENTIFIC

For more information, please visit our website:

SigmaAldrich.com/Milli-Q-IX

© 2020 Merck KGaA, Darmstadt, Germany and/or its affiliates. All Rights Reserved. Merck, the vibrant M, Milli-Q, MyMilli-Q, E-POD, Elix, ech₂o, IPAK Gard, Millipak and Biopak are trademarks of Merck KGaA, Darmstadt, Germany or its affiliates. All other trademarks are the property of their respective owners. Detailed information on trademarks is available via publicly accessible resources.

Lit. No. MK_BR5592EN