

# Surveyor UV/Vis Plus

## Hardware Manual

60053-97108 Revision C March 2008

© 2007 Thermo Fisher Scientific Inc. All rights reserved.

Surveyor Plus™ and ChromQuest™ are trademarks of Thermo Fisher Scientific Inc. in the United States. Microsoft® and Windows® are registered trademarks of Microsoft Corporation. Delrin®, Teflon®, and Tefzel® are registered trademarks of E.I. du Pont de Nemours & Company. Kel-F® is a registered trademark of 3M Company. All other trademarks are the property of Thermo Fisher Scientific Inc. and its subsidiaries.

Thermo Fisher Scientific Inc. provides this document to its customers with a product purchase to use in the product operation. This document is copyright protected and any reproduction of the whole or any part of this document is strictly prohibited, except with the written authorization of Thermo Fisher Scientific Inc.

The contents of this document are subject to change without notice. All technical information in this document is for reference purposes only. System configurations and specifications in this document supersede all previous information received by the purchaser.

**Thermo Fisher Scientific Inc. makes no representations that this document is complete, accurate or error-free and assumes no responsibility and will not be liable for any errors, omissions, damage or loss that might result from any use of this document, even if the information in the document is followed properly.**

This document is not part of any sales contract between Thermo Fisher Scientific Inc. and a purchaser. This document shall in no way govern or modify any Terms and Conditions of Sale, which Terms and Conditions of Sale shall govern all conflicting information between the two documents.

Release history: Revision A released in October 2005. Revision B released in April 2006. Revision C released in March 2008.

**For Research Use Only. Not regulated for medical or veterinary diagnostic use by U.S. Federal Drug Administration or other competent authorities.**

## WEEE Compliance

This product is required to comply with the European Union's Waste Electrical & Electronic Equipment (WEEE) Directive 2002/96/EC. It is marked with the following symbol:



Thermo Fisher Scientific has contracted with one or more recycling or disposal companies in each European Union (EU) Member State, and these companies should dispose of or recycle this product. See [www.thermo.com/WEEERoHS](http://www.thermo.com/WEEERoHS) for further information on Thermo Fisher Scientific's compliance with these Directives and the recyclers in your country.

## WEEE Konformität

Dieses Produkt muss die EU Waste Electrical & Electronic Equipment (WEEE) Richtlinie 2002/96/EC erfüllen. Das Produkt ist durch folgendes Symbol gekennzeichnet:



Thermo Fisher Scientific hat Vereinbarungen mit Verwertungs-/Entsorgungsfirmen in allen EU-Mitgliedsstaaten getroffen, damit dieses Produkt durch diese Firmen wiederverwertet oder entsorgt werden kann. Mehr Information über die Einhaltung dieser Anweisungen durch Thermo Fisher Scientific, über die Verwerter, und weitere Hinweise, die nützlich sind, um die Produkte zu identifizieren, die unter diese RoHS Anweisung fallen, finden sie unter [www.thermo.com/WEEERoHS](http://www.thermo.com/WEEERoHS).

## Conformité DEEE

Ce produit doit être conforme à la directive européenne (2002/96/EC) des Déchets d'Equipements Electriques et Electroniques (DEEE). Il est marqué par le symbole suivant:



Thermo Fisher Scientific s'est associé avec une ou plusieurs compagnies de recyclage dans chaque état membre de l'union européenne et ce produit devrait être collecté ou recyclé par celles-ci. Davantage d'informations sur la conformité de Thermo Fisher Scientific à ces directives, les recycleurs dans votre pays et les informations sur les produits Thermo Fisher Scientific qui peuvent aider la détection des substances sujettes à la directive RoHS sont disponibles sur [www.thermo.com/WEEERoHS](http://www.thermo.com/WEEERoHS).



## Regulatory Compliance

Thermo Fisher Scientific performs complete testing and evaluation of its products to ensure full compliance with applicable domestic and international regulations. When the system is delivered to you, it meets all pertinent electromagnetic compatibility (EMC) and safety standards as described below.

### EMC Directive 89/336/EEC amended by 92/31/EEC and 93/68/EEC

EMC compliance has been evaluated by Underwriters Laboratories Inc.

EN 55011	1998	EN 61000-4-3	2002
EN 61000-3-2	1995, A1; 1998, A2; 1998, A14; 2000	EN 61000-4-4	1995, A1; 2001, A2; 2001
IEC 61000-3-2	2000	EN 61000-4-5	1995, A1; 2001
EN 61000-3-3	1995	EN 61000-4-6	1996, A1; 2001
IEC 61000-3-3	1994	EN 61000-4-11	1994, A1; 2001
EN 61326-1	1997	ENV 50204	1995
EN 61000-4-2	1995 A1; 1998 A2; 2001	CISPR 11	1999, A1; 1999, A2; 2002
FCC Class A, CFR 47 Part 15 Subpart B; 2003			

### Low Voltage Safety Compliance

This device complies with Low Voltage Directive EN 61010-1:2001.

Changes that you make to your system may void compliance with one or more of these EMC and safety standards. Changes to your system include replacing a part or adding components, options, or peripherals not specifically authorized and qualified by Thermo Fisher Scientific. To ensure continued compliance with EMC and safety standards, replacement parts and additional components, options, and peripherals must be ordered from Thermo Fisher Scientific or one of its authorized representatives.

## FCC Compliance Statement

THIS DEVICE COMPLIES WITH PART 15 OF THE FCC RULES. OPERATION IS SUBJECT TO THE FOLLOWING TWO CONDITIONS: (1) THIS DEVICE MAY NOT CAUSE HARMFUL INTERFERENCE, AND (2) THIS DEVICE MUST ACCEPT ANY INTERFERENCE RECEIVED, INCLUDING INTERFERENCE THAT MAY CAUSE UNDESIRE OPERATION.



**CAUTION** Read and understand the various precautionary notes, signs, and symbols contained inside this manual pertaining to the safe use and operation of this product before using the device.

## Notice on Lifting and Handling of Thermo Scientific Instruments

For your safety, and in compliance with international regulations, the physical handling of this Thermo Fisher Scientific instrument *requires a team effort* to lift and/or move the instrument. This instrument is too heavy and/or bulky for one person alone to handle safely.







## Notice on the Proper Use of Thermo Scientific Instruments

In compliance with international regulations: Use of this instrument in a manner not specified by Thermo Fisher Scientific could impair any protection provided by the instrument.

## Notice on the Susceptibility to Electromagnetic Transmissions

Your instrument is designed to work in a controlled electromagnetic environment. Do not use radio frequency transmitters, such as mobile phones, in close proximity to the instrument.

For manufacturing location, see the label on the instrument.

CAUTION Symbol	CAUTION	VORSICHT	ATTENTION	PRECAUCION	AVVERTENZA
	<b>Electric Shock:</b> This instrument uses high voltages that can cause personal injury. Before servicing, shut down the instrument and disconnect the instrument from line power. Keep the top cover on while operating the instrument. Do not remove protective covers from PCBs.	<b>Elektroschock:</b> In diesem Gerät werden Hochspannungen verwendet, die Verletzungen verursachen können. Vor Wartungsarbeiten muß das Gerät abgeschaltet und vom Netz getrennt werden. Betreiben Sie Wartungsarbeiten nicht mit abgenommenem Deckel. Nehmen Sie die Schutzabdeckung von Leiterplatten nicht ab.	<b>Choc électrique:</b> L'instrument utilise des tensions capables d'infliger des blessures corporelles. L'instrument doit être arrêté et débranché de la source de courant avant tout intervention. Ne pas utiliser l'instrument sans son couvercle. Ne pas enlever les étuis protecteurs des cartes de circuits imprimés.	<b>Descarga eléctrica:</b> Este instrumento utiliza altas tensiones, capaces de producir lesiones personales. Antes de dar servicio de mantenimiento al instrumento, éste deberá apagarse y desconectarse de la línea de alimentación eléctrica. No opere el instrumento sin sus cubiertas exteriores quitadas. No remueva las cubiertas protectoras de las tarjetas de circuito impreso.	<b>Shock da folgorazione.</b> L'apparecchio è alimentato da corrente ad alta tensione che può provocare lesioni fisiche. Prima di effettuare qualsiasi intervento di manutenzione occorre spegnere ed isolare l'apparecchio dalla linea elettrica. Non attivare lo strumento senza lo schermo superiore. Non togliere i coperchi a protezione dalle schede di circuito stampato (PCB).
	<b>Chemical:</b> This instrument might contain hazardous chemicals. Wear gloves when handling toxic, carcinogenic, mutagenic, or corrosive or irritant chemicals. Use approved containers and proper procedures to dispose waste oil.	<b>Chemikalien:</b> Dieses Gerät kann gefährliche Chemikalien enthalten. Tragen Sie Schutzhandschuhe beim Umgang mit toxischen, karzinogenen, mutagenen oder ätzenden/reizenden Chemikalien. Entsorgen Sie verbrauchtes Öl entsprechend den Vorschriften in den vorgeschriebenen Behältern.	<b>Chimique:</b> Des produits chimiques dangereux peuvent se trouver dans l'instrument. Portez des gants pour manipuler tous produits chimiques toxiques, cancérigènes, mutagènes, ou corrosifs/irritants. Utilisez des récipients et des procédures homologuées pour se débarrasser des déchets d'huile.	<b>Química:</b> El instrumento puede contener productos químicos peligrosos. Utilice guantes al manejar productos químicos tóxicos, carcinógenos, mutágenos o corrosivos/irritantes. Utilice recipientes y procedimientos aprobados para deshacerse del aceite usado.	<b>Prodotti chimici.</b> Possibile presenza di sostanze chimiche pericolose nell'apparecchio. Indossare dei guanti per maneggiare prodotti chimici tossici, cancerogeni, mutageni, o corrosivi/irritanti. Utilizzare contenitori aprovo e seguire la procedura indicata per lo smaltimento dei residui di olio.
	<b>Heat:</b> Before servicing the instrument, allow any heated components to cool.	<b>Hitze:</b> Warten Sie erhitzte Komponenten erst nachdem diese sich abgekühlt haben.	<b>Haute Temperature:</b> Permettre aux composants chauffés de refroidir avant tout intervention.	<b>Altas temperaturas:</b> Permita que los componentes se enfríen, ante de efectuar servicio de mantenimiento.	<b>Calore.</b> Attendere che i componenti riscaldati si raffreddino prima di effettuare l'intervento di manutenzione.
	<b>Fire:</b> Use care when operating the system in the presence of flammable gases.	<b>Feuer:</b> Beachten Sie die einschlägigen Vorsichtsmaßnahmen, wenn Sie das System in Gegenwart von entzündbaren Gasen betreiben.	<b>Incendie:</b> Agir avec précaution lors de l'utilisation du système en présence de gaz inflammables.	<b>Fuego:</b> Tenga cuidado al operar el sistema en presencia de gases inflamables.	<b>Incendio.</b> Adottare le dovute precauzioni quando si usa il sistema in presenza di gas infiammabili.
	<b>Eye Hazard:</b> Eye damage could occur from splattered chemicals or flying particles. Wear safety glasses when handling chemicals or servicing the instrument.	<b>Verletzungsgefahr der Augen:</b> Verspritzte Chemikalien oder kleine Partikel können Augenverletzungen verursachen. Tragen Sie beim Umgang mit Chemikalien oder bei der Wartung des Gerätes eine Schutzbrille.	<b>Danger pour les yeux:</b> Des projections chimiques, liquides, ou solides peuvent être dangereuses pour les yeux. Porter des lunettes de protection lors de toute manipulation de produit chimique ou pour toute intervention sur l'instrument.	<b>Peligro par los ojos:</b> Las salicaduras de productos químicos o partículas que saltan bruscamente pueden causar lesiones en los ojos. Utilice anteojos protectores al manipular productos químicos o al darle servicio de mantenimiento al instrumento.	<b>Pericolo per la vista.</b> Gli schizzi di prodotti chimici o delle particelle presenti nell'aria potrebbero causare danni alla vista. Indossare occhiali protettivi quando si maneggiano prodotti chimici o si effettuano interventi di manutenzione sull'apparecchio.
	<b>General Hazard:</b> A hazard is present that is not included in the above categories. Also, this symbol appears on the instrument to refer the user to instructions in this manual.  When the safety of a procedure is questionable, contact your local Technical Support organization for Thermo Fisher Scientific San Jose Products.	<b>Allgemeine Gefahr:</b> Es besteht eine weitere Gefahr, die nicht in den vorstehenden Kategorien beschrieben ist. Dieses Symbol wird im Handbuch außerdem dazu verwendet, um den Benutzer auf Anweisungen hinzuweisen.  Wenn Sie sich über die Sicherheit eines Verfahrens im unklaren sind, setzen Sie sich, bevor Sie fortfahren, mit Ihrer lokalen technischen Unterstützungsorganisation für Thermo Fisher Scientific San Jose Produkte in Verbindung.	<b>Danger général:</b> Indique la présence d'un risque n'appartenant pas aux catégories citées plus haut. Ce symbole figure également sur l'instrument pour renvoyer l'utilisateur aux instructions du présent manuel.  Si la sûreté d'une procédure est incertaine, avant de continuer, contactez le plus proche Service Clientèle pour les produits de Thermo Fisher Scientific San Jose.	<b>Peligro general:</b> Significa que existe un peligro no incluido en las categorías anteriores. Este símbolo también se utiliza en el instrumento para referir al usuario a las instrucciones contenidas en este manual.  Cuando la certidumbre acerca de un procedimiento sea dudosa, antes de proseguir, pongase en contacto con la Oficina de Asistencia Técnica local para los productos de Thermo Fisher Scientific San Jose.	<b>Pericolo generico.</b> Pericolo non compreso tra le precedenti categorie. Questo simbolo è utilizzato inoltre sull'apparecchio per segnalare all'utente di consultare le istruzioni descritte nel presente manuale.  Quando è in dubbio la misura di sicurezza per una procedura, prima di continuare, si prega di mettersi in contatto con il Servizio di Assistenza Tecnica locale per i prodotti di Thermo Fisher Scientific San Jose.

## CAUTION Symbol

## CAUTION

## 危険警告

## 危險警告



**Electric Shock:** This instrument uses high voltages that can cause personal injury. Before servicing, shut down the instrument and disconnect the instrument from line power. Keep the top cover on while operating the instrument. Do not remove protective covers from PCBs.

**電撃:** この計測器は高電圧を使用し、人体に危害を与える可能性があります。保守・修理は、必ず作業を停止し、電源を切ってから実施して下さい。上部カバーを外したままで計測器を使用しないで下さい。プリント配線板の保護カバーは外さないで下さい。

**電撃:** 儀器設備使用會造成人身傷害的高伏電壓。在維修之前，必須先關儀器設備並切除電源。務必要在頂蓋蓋上的情況下操作儀器。請勿拆除PCB保護蓋。



**Chemical:** This instrument might contain hazardous chemicals. Wear gloves when handling toxic, carcinogenic, mutagenic, or corrosive or irritant chemicals. Use approved containers and proper procedures to dispose waste oil.

**化学物質:** 危険な化学物質が計測器中に存在している可能性があります。毒性、発がん性、突然変異性、腐食・刺激性などのある薬品を取り扱う際は、手袋を着用して下さい。廃油の処分には、規定の容器と手順を使用して下さい。

**化学品:** 儀器設備中可能存在有危險性的化學物品。接觸毒性致癌、誘變或腐蝕/刺激性化學品時，請配帶手套。處置廢油時，請使用經過許可的容器和程序。



**Heat:** Before servicing the instrument, allow any heated components to cool.

**熱:** 熱くなった部品は冷えるのを待ってから保守・修理を行って下さい。

**高温:** 請先等高温零件冷卻之後再進行維修。



**Fire:** Use care when operating the system in the presence of flammable gases.

**火災:** 可燃性のガスが存在する場所でシステムを操作する場合は、充分な注意を払って下さい。

**火災:** 在有易燃氣體的場地操作該系統時，請務必小心謹慎。



**Eye Hazard:** Eye damage could occur from splattered chemicals or flying particles. Wear safety glasses when handling chemicals or servicing the instrument.

**眼に対する危険:** 化学物質や微粒子が飛散して眼を傷つける危険性があります。化学物質の取り扱い、あるいは計測器の保守・修理に際しては防護眼鏡を着用して下さい。

**眼睛傷害危険:** 飛濺の化学品或顆粒可能造成眼睛傷害。處理化學品或維儀器設備時請佩戴安全眼鏡。



**General Hazard:** A hazard is present that is not included in the above categories. Also, this symbol appears on the instrument to refer the user to instructions in this manual.

**一般的な危険:** この標識は上記以外のタイプの危険が存在することを示します。また、計測器にこの標識がついている場合は、本マニュアル中の指示を参照して下さい。

**一般性危険:** 説明未包括在上述類別中的其他危險。此外，儀器設備上使用這個標誌，以指示用戶本使用手冊中的說明。

When the safety of a procedure is questionable, contact your local Technical Support organization for Thermo Fisher Scientific San Jose Products.

**安全を確保する手順がよくわからない時は、作業を一時中止し、お近くのサーモエレクトロンサンローゼプロダクトのテクニカルサポートセンターにご連絡ください。**

**如對安全程序有疑問，請在操作之前與當地的菲尼根技術服務中心聯繫。**



# Contents

	<b>Preface</b> .....	<b>xi</b>
	About This Guide .....	xi
	Related Documentation .....	xi
	Safety and Special Notices .....	xi
	Contacting Us .....	xii
<b>Chapter 1</b>	<b>Introduction</b> .....	<b>1</b>
	Functional Description .....	2
	LightPipe Flowcell .....	3
	Specifications .....	5
<b>Chapter 2</b>	<b>Installation</b> .....	<b>7</b>
	Installation Checklist .....	8
	Unpacking and Inspecting Instrument .....	8
	Making Initial Instrument Preparations .....	9
	Checking the Power Setting and Fuses .....	10
	Making Initial Rear Panel Connections .....	11
	Ethernet Connection .....	11
	Analog Output Connections .....	11
	Analog Output Settings .....	13
	Unit ID Settings .....	13
	Remote Communications Connections .....	13
	Connecting and Installing the Flow Cell .....	15
	Powering On the Detector for the First Time .....	16
<b>Chapter 3</b>	<b>Maintenance</b> .....	<b>19</b>
	Recommendations for Routine Maintenance .....	20
	Tools Required .....	20
	Cleaning Detector External Surfaces .....	20
	LightPipe Flow Cell .....	21
	Removing the LightPipe Flow Cell .....	21
	Storing the LightPipe Flow Cell .....	24
	Installing the LightPipe Mounting Assembly .....	24
	Installing the LightPipe Flow Cell .....	25

Standard Analytical Flow Cell . . . . .	27
Removing the Standard Flow Cell Assembly . . . . .	27
Installing the Standard Analytical Flow Cell . . . . .	29
Cleaning Flow Cells . . . . .	30
Cleaning with Organic Solvents . . . . .	30
Cleaning with Nitric Acid . . . . .	31
Replacing the Lamps . . . . .	32
The Deuterium Lamp . . . . .	33
The Tungsten Lamp . . . . .	35
<b>Chapter 4 Troubleshooting . . . . .</b>	<b>39</b>
Detector-Related Problems . . . . .	40
Error Messages . . . . .	44
<b>Chapter 5 Accessories and Replaceable Parts . . . . .</b>	<b>47</b>
Replaceable Parts . . . . .	47
Optional Flow Cells for the UV/Vis Detector . . . . .	48
<b>Appendix A Surveyor Firmware Upgrade Utility . . . . .</b>	<b>49</b>
<b>Index . . . . .</b>	<b>53</b>

# Preface

## About This Guide

This *Surveyor UV/Vis Plus Detector Hardware Manual* provides you with information on how to set up and maintain your Surveyor UV/Vis Plus detector.

## Related Documentation

In addition to this guide, Thermo Fisher Scientific provides the following documents for the Surveyor UV/Vis Plus Detector:

- *Surveyor Plus Preinstallation Requirements Guide*
- *Surveyor Plus Getting Connected Guide*
- *Surveyor Plus Getting Started with ChromQuest*

## Safety and Special Notices

Make sure you follow the precautionary statements presented in this guide. The safety and other special notices appear in boxes.

Safety and special notices include the following:



**CAUTION** Highlights hazards to humans, property, or the environment. Each CAUTION notice is accompanied by an appropriate CAUTION symbol.

**IMPORTANT** Highlights information necessary to prevent damage to software, loss of data, or invalid test results; or might contain information that is critical for optimal performance of the system.

**Note** Highlights information of general interest.

**Tip** Highlights helpful information that can make a task easier.

## Contacting Us

There are several ways to contact Thermo Fisher Scientific for the information you need.

❖ **To contact Technical Support**

Phone	800-685-9535
Fax	561-688-8736
E-mail	<a href="mailto:TechSupport.C+MS@thermofisher.com">TechSupport.C+MS@thermofisher.com</a>
Knowledge base	<a href="http://www.thermokb.com">www.thermokb.com</a>

Find software updates and utilities to download at [www.mssupport.thermo.com](http://www.mssupport.thermo.com).

❖ **To contact Customer Service for ordering information**

Phone	800-532-4752
Fax	561-688-8731
Web site	<a href="http://www.thermo.com/ms">www.thermo.com/ms</a>

❖ **To copy manuals from the Internet**

Go to [mssupport.thermo.com](http://mssupport.thermo.com) and click **Customer Manuals** in the left margin of the window.

❖ **To suggest changes to documentation or to Help**

- Fill out a reader survey online at [www.thermo.com/lcms-techpubs](http://www.thermo.com/lcms-techpubs).
- Send an e-mail message to the Technical Publications Editor at [techpubs-lcms@thermofisher.com](mailto:techpubs-lcms@thermofisher.com).

# Introduction

The Surveyor UV/Vis Plus Detector shown in [Figure 1](#) is a member of the Surveyor Plus™ family of LC instruments.

This chapter provides an introduction to the Surveyor UV/Vis Plus Detector.

## Contents

- [Functional Description](#)
- [LightPipe Flowcell](#)
- [Specifications](#)

**Figure 1.** Surveyor UV/Vis Plus Detector



## Functional Description

The Surveyor UV/Vis Plus Detector is a full-featured, time-programmable, variable-wavelength UV/Vis (ultraviolet / visible) absorbance detector. It operates in either the single or dual wavelength mode in the UV or visible ranges.

The UV/Vis detector is a bench top unit for inclusion into the Surveyor LC System. It is controlled remotely over an Ethernet communications link from a PC using ChromQuest software.

The UV/Vis detector consists of a dual light source, an optical bench (see Figure 2), dual photodiode detectors, and several printed circuit boards (PCBs).

**Figure 2.** The Surveyor UV/Vis Plus Detector optical bench

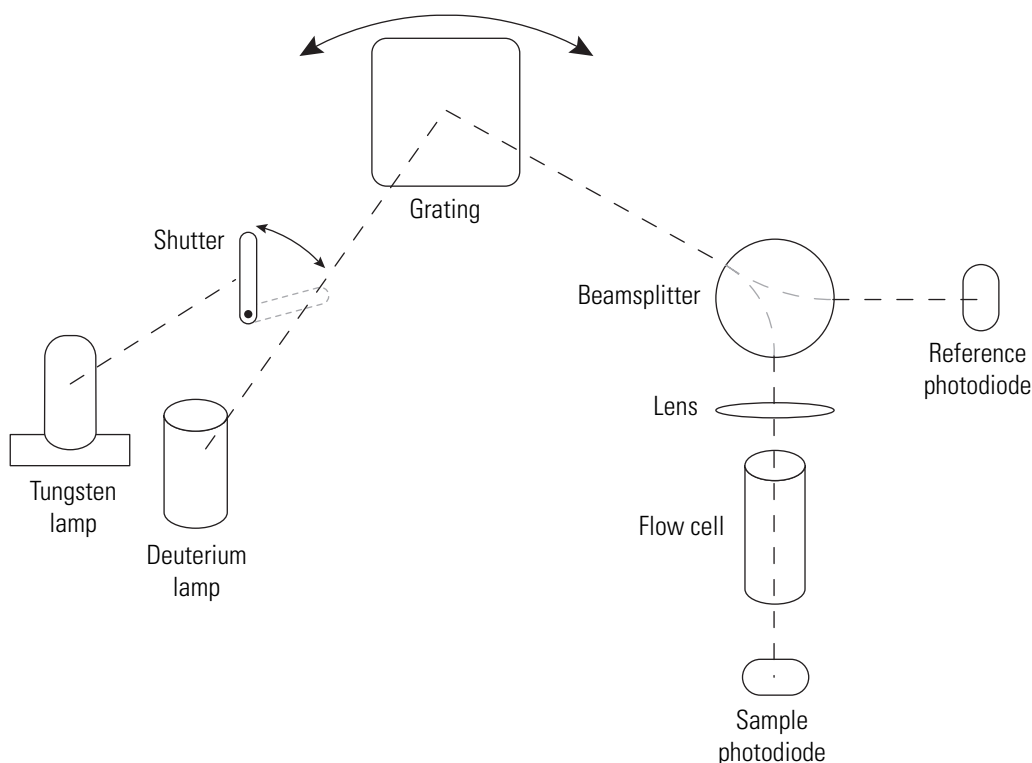

To provide a complete spectrum of ultraviolet and visible light, the detector uses a deuterium lamp for the UV range (190-365 nm) and a tungsten lamp for the visible range (366-800 nm). The lamps are protected by a cover with a special safety interlock to reduce the possibility of human exposure to harmful UV light. A computer-controlled shutter selects which lamp is used for sample analysis. The light from the selected lamp goes to a holographic grating that disperses the light into a spectrum. The grating can be turned to select which portion of the spectrum and which wavelength of light is used. The alignment of the grating is controlled by a stepper motor for precise wavelength control. Absorbance linearity is increased by a system of baffles that reduces stray light in the optical bench.

From the grating, the light travels to a fiber optic beamsplitter, where a portion of the light is redirected to a reference photodiode. The signal from the reference photodiode is used to compensate for changes in lamp intensity and helps to maintain consistent performance as the lamp performance varies. From the beamsplitter, most of the light passes through a lens and then on through the flow cell and onto the sample photodiode. The light falling on the sample photodiode is then processed by the analog PC board and converted into data that can be analyzed by the computer.

The available flow cell options include:

- Standard analytical flow cell with a 10 mm pathlength
- LightPipe flow cell with a 50 mm pathlength

Other flow cells can also be used in the detector. See [Table 3](#).

LEDs on the front of the module keep the user informed of power, communications, run, and lamp status.

## LightPipe Flowcell

The Surveyor UV/Vis Plus Detector can be ordered with a 50 mm LightPipe flowcell.

The internal bore of the LightPipe flowcell is 50 mm long and has a volume of 10  $\mu\text{L}$ . The 5 cm optical pathlength produces a signal five times that of a conventional 1 cm flowcell, while the low internal volume of 10  $\mu\text{L}$  minimizes band broadening. A special low refractive index coating of the internal bore ensures a high optical throughput and minimizes short-term noise.

Mobile phase enters the LightPipe flowcell through a port in the bottom of the flowcell and exits through a port in the top of the flowcell. See [Figure 3](#). Directing the flow from the bottom to the top of the flowcell reduces the development of air bubbles.

**Figure 3.** Schematic of LightPipe flowcell, showing the internal flowpath

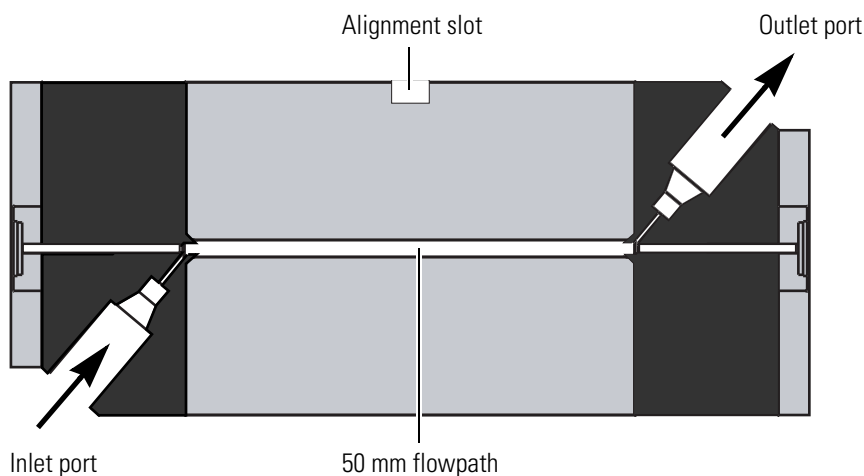

Sensitive optical fibers are exposed at both ends of the flowcell as shown in [Figure 4](#). Thermo Fisher Scientific ships the LightPipe flowcell with end caps to protect these optical fibers. See [Figure 5](#). Leave these protective end caps in place until you install the LightPipe flowcell. Replace the protective end caps for storage if you remove the LightPipe flowcell from the detector.



**CAUTION** Do *not* touch the ends of the LightPipe flowcell. Doing so could damage the sensitive optical fibers. If you must grasp the ends of the LightPipe flowcell, wear clean, talc-free gloves.

**Figure 4.** End of LightPipe flowcell, showing the sensitive optical fiber

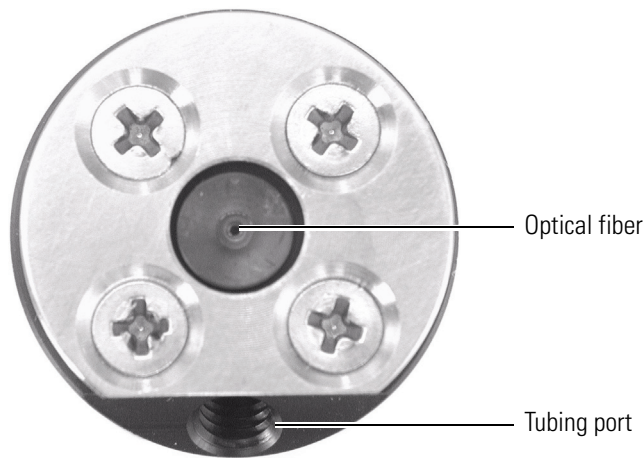

**Figure 5.** LightPipe flowcell with protective end caps

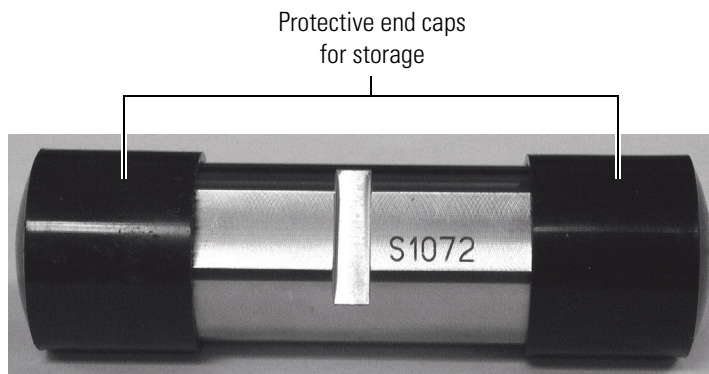



## Specifications

Light Source:	Deuterium and tungsten lamps, re-aligned
Wavelength Range:	190 nm to 800 nm <ul style="list-style-type: none"> <li>• D<sub>2</sub> Lamp: 190 to 365 nm</li> <li>• W Lamp: 366 to 800 nm</li> </ul>
Wavelength Accuracy:	±1 nm at 254 nm and 656 nm
Spectral Bandwidth:	6 nm
Absorbance Range:	0.0005 AUFS to +3.0 AUFS
Short Term Noise* :	<ul style="list-style-type: none"> <li>• 6 µAU/cm at 254 nm, 1 s rise time, single wavelength mode (50 mm LightPipe flow cell)</li> <li>• 20 µAU/cm at 254 nm, 1 s rise time, single wavelength mode (10 mm standard analytical flow cell)</li> </ul>
Drift*:	<ul style="list-style-type: none"> <li>• ≤ 1 mAU/h at 254 nm and 546 nm (50 mm LightPipe flow cell)</li> <li>• ≤ 0.1 mAU/h at 254 nm and 546 nm (10 mm standard analytical flow cell)</li> </ul>
Warm-up:	90 min to meet noise and drift specifications
Linearity:	deviation ≤ 5% up to 2.0 AU at 256 nm
Scan Rate:	4, 5, 6.67, 10, or 20 Hz (user selectable)
Rise Time:	0, 0.1, 0.2, 0.5, 1, 2, 3, 4, or 5 s (user selectable)
Cell Dimensions:	<ul style="list-style-type: none"> <li>• 10 mm, 15 µL standard analytical</li> <li>• 50 mm, 10 µL LightPipe</li> </ul>
Cell Pressure Rating:	1000 psi
Analog Outputs (2):	Unattenuated at 10 mV/AU, 100 mV/AU, or 1.0 V/AU
Remote Controls:	Start, Zero, RJ45 Ethernet interface for ChromQuest
Dimensions:	18 cm (7.1 in.) × 36 cm (14.2 in.) × 47 cm (18.5 in.) ( <i>b × w × d</i> )
Weight:	19.5 kg (43 lbs)
Power Requirements:	100/115 or 230 V ac; 50/60 Hz, 225 VA max.
Fuses:	<ul style="list-style-type: none"> <li>• 2.5 A at 100/115 V ac (slo-blo)</li> <li>• 1.25 A at 230 V ac (slo-blo)</li> </ul>
Operating Temperature:	+10 to +30 °C
Storage Temperature:	- 40 to +70 °C
Operating Humidity:	5% to 95% non-condensing relative humidity
Product Certification:	CE, TUV-C/US, FCC (EMI)

\* According to ASTM E1657-94 "Standard Practice for Testing Variable-Wavelength Photometric Detectors Used in Liquid Chromatography" (for 50 mm flow cell, 5 nm bandwidth, 2 sec rise time, and MeOH at 1 mL/min.).



# Installation

This chapter describes the initial installation of your Surveyor UV/Vis Plus Detector, including connection to other chromatographic instrumentation. The Installation Checklist, on the back of this page, is an abbreviated version of this chapter and can be used as a quick reference of how to conduct a successful installation. Make a copy of the checklist and fill it out when the installation is complete. Include the completed checklist in your maintenance records.

**Note** Perform the installation in the sequence presented on the Installation Checklist and detailed in this chapter.

## Contents

- [Installation Checklist](#)
- [Unpacking and Inspecting Instrument](#)
- [Making Initial Instrument Preparations](#)
- [Checking the Power Setting and Fuses](#)
- [Making Initial Rear Panel Connections](#)
- [Connecting and Installing the Flow Cell](#)
- [Powering On the Detector for the First Time](#)

## Installation Checklist

The following installation checklist is a brief summary of the steps that you need to complete for the proper installation of your Surveyor UV/Vis Plus Detector:

- Unpack and inspect your instrument ([page 8](#)).
- Read the safety notices in the preface of this manual.
- Make the initial instrument preparations ([page 8](#)).
- Check the power settings and fuses ([page 10](#)).
- Make the initial rear panel connections ([page 11](#))
- Connect and install the flow cell ([page 15](#))
- Power on the detector for the first time ([page 16](#))
- Download the Surveyor UV/Vis Plus Detector firmware, if required ([Appendix A, “Surveyor Firmware Upgrade Utility.”](#) )

This Surveyor UV/Vis Plus Detector was installed by:

---

(Name)

(Date)

## Unpacking and Inspecting Instrument

Carefully remove the detector from the shipping container and inspect both the detector and the packaging for any signs of damage. If you find any damage, save the shipping materials and immediately contact the shipping company.

The shipping container should contain the following items:

- Surveyor UV/Vis Plus Detector
- Accessory kit

Detectors ordered with a standard 10 mm flow cell arrive with the flow cell installed in the detector. Detectors ordered with the 50 mm LightPipe are shipped with the LightPipe packaged in the accessory kit.

The accessory kit (P/N 60053-62004) contains the items listed in [Table 1](#). Carefully check to make sure you have received all the items listed on the packing list. If any items are missing, contact your Thermo Fisher Scientific representative immediately.

**Table 1.** Surveyor UV/Vis accessory kit

Item	Quantity	Part Number
Cable, Ext. Run/Auto Zero	1	6040-0102
8-pin cable connector, 3.81 mm pitch, minicombico	2	00004-02511
Cable, RJ45 Ethernet communication, CAT-5, shielded	1	70111-63302
Cable, analog SS DET	2	6040-0103
Nut, 1/16-in., 1/4-28	2	3256-0024
Ferrule, 7/4-28 ETFE	2	3256-0025
Nut and Ferrule set tube	1	3256-0022
LC Test Mix, 1 mL	1	A3469-020
Funnel, Surveyor	1	F3012-010
Tubing, convoluted, detector drain	1	F5034-010
Screwdriver, Hex, ball end, 3/32-in, black	1	00725-00040
Screwdriver, Hex, ball end, 1/8-in, black	1	00725-00042
Screwdriver, Hex, ball end, 9/64-in, black	1	00725-00044
Surveyor UV/Vis Plus Detector Hardware manual	1	60053-97108

## Making Initial Instrument Preparations

Place the detector on a bench top as close as possible to the chromatographic column outlet (minimizing the length of tubing necessary for connection to the flow cell inlet). If you are using other Surveyor modules, place the UV/Vis detector on top of the Surveyor Autosampler Plus. Be sure to place the HPLC system in a draft-free location away from an open window, air conditioner vents, or other circulating air source. A stable room temperature ( $\pm 0.5$  °C) is necessary for applications requiring maximum detection sensitivity. Allow at least 15 cm (6 in.) of clear space between the rear panel of the detector and any wall or obstruction. This provides access to the rear-panel connectors and a free flow of cooling air.

You will need the following tools for installation:

- narrow-tip screwdriver (2 mm wide)
- #2 Phillips screwdriver
- 1/4 in. open end wrench
- 1/8-in. hex wrench (supplied)
- 3/32-in. hex wrench (supplied)
- 9/64-in. hex wrench (supplied)

## Checking the Power Setting and Fuses

The detector is shipped with the voltage and fuses preset for your location. To verify the power setting, look through the cut-out window on the power entry module located at the lower right on the detector rear panel. See [Figure 6](#).

**Figure 6.** Power entry module showing selection of the voltage

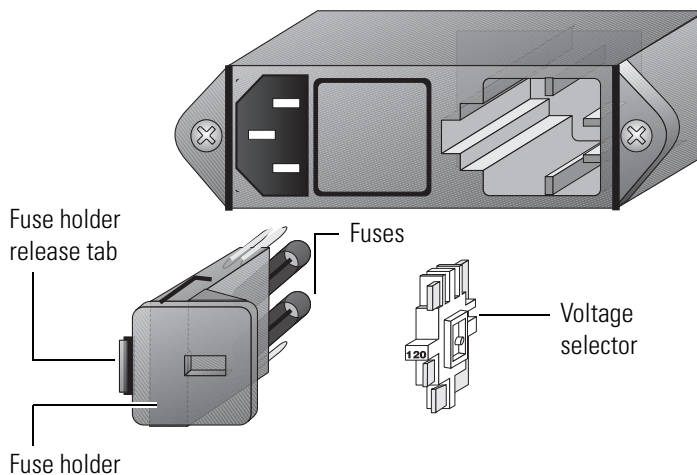

**CAUTION** Do not connect the power cord to your instrument without first verifying that the voltage is properly set for your location! Never connect the detector to, or operate the detector with, an electrical line source with power fluctuations greater than 10% above or below the nominal rated line voltage!

### ❖ To check the fuses and change the voltage setting, if necessary

1. Place the tip of the narrow-blade screwdriver in the small slot to the left of the fuse holder in the power entry module and push to the right. The fuse holder should pop out.
2. Pull the fuse holder out of the power entry module.
3. Verify that the fuse holder contains the appropriate size fuses: T2.5 A for 100/115 V, or T1.25 A for 230 V.
4. If necessary, slide out the voltage selection PC board and re-install it so that the desired voltage label is upright and readable. This voltage must agree with the incoming line voltage.
5. Slide the fuse holder back into the power entry module until it snaps in.

**IMPORTANT** Do not connect the power cord or turn on the detector yet. Wait until you perform the procedure in [‘Powering On the Detector for the First Time’](#) on [page 16](#) to connect the power cord.

## Making Initial Rear Panel Connections

Use the cables provided in the installation kit to make the connections to the detector rear panel, as described in this section. See [Figure 7](#).

This section contains the following topics:

- [Ethernet Connection](#)
- [Analog Output Connections](#)
- [Analog Output Settings](#)
- [Unit ID Settings](#)
- [Remote Communications Connections](#)

### Ethernet Connection

Connect your Ethernet switch to the Ethernet connector outlet of the detector using the supplied shielded Ethernet cable (P/N 70111-63302).

### Analog Output Connections

Two analog signal cables (twin axial computer cables) are provided in the installation kit to use for connecting the analog outputs from the UV/Vis detector to other data collection devices.

The analog signal cables have three wires protruding from the ends of the shielded cable. Two of these wires are electrically insulated. They are used for carrying an analog signal to data collection devices. Typically, the wire with the clear insulation is connected to the positive analog output, and the wire with the black insulation is connected to the signal ground (sometimes referred to as the negative signal).

**Figure 7.** UV/Vis detector rear panel, showing the location of the connectors and power entry module

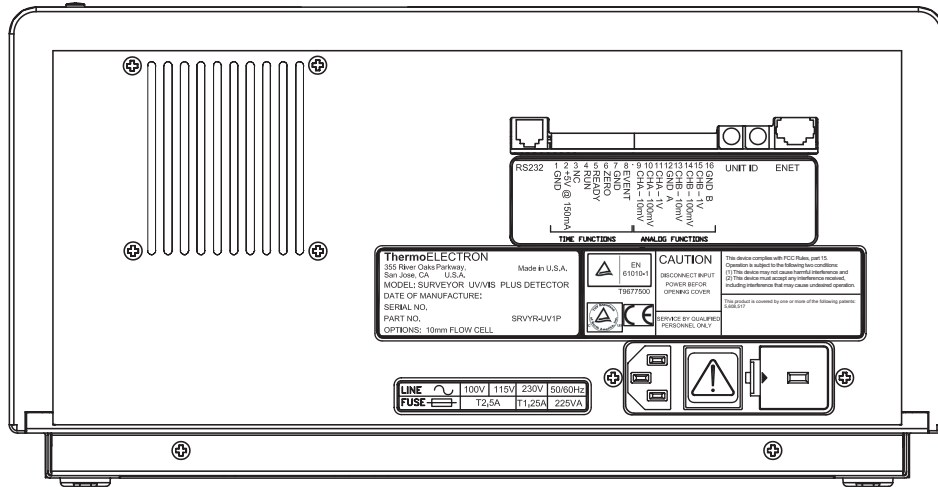

The third wire is not insulated. This bare wire is used to ground the cable shielding. The cable shielding reduces signal noise caused by radio frequency interference. The cable shielding is most effective if the bare wire is grounded at just one end.

At the detector rear panel there are three different analog voltage outputs per channel: CHA – 10 mV, CHA – 100 mV, CHA – 1 V, CHB – 10 mV, CHB – 100 mV, CHB – 1 V; and a single ground per channel: GND A and GND B.

Each of the analog signal wire ends in the signal cables have a 1/4-in. of bare, tinned wire. The ends are stripped and soldered to allow electrical contact and to prevent fraying. To make each electrical connection, do the following: Insert the end of the wire into the appropriate terminal in the 8-pin terminal connector. Hold the wire in place while you tighten the small terminal set screw firmly onto the wire. Insert the terminal connector into the contact pins numbered 9 through 16 at the back of the instrument. See [Figure 8](#).

**IMPORTANT** Do not connect the detector ground terminals to any earth ground on your data system computer. This incorrect connection will lead to an increased noise level and a subsequent decrease in sensitivity.

**Figure 8.** UV/Vis detector outputs full-scale voltage connections

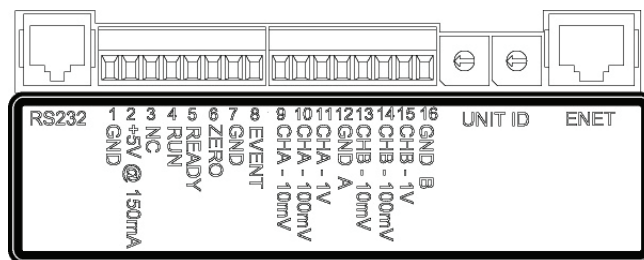



## Analog Output Settings

The analog outputs are controlled by the wavelength, bandwidth, rise time, and zero functions of the detector. These outputs are compatible with data collection systems using any of the three different voltages (10 mV, 100 mV, or 1 V) by selecting the appropriate terminal of the analog output terminal connector (Figure 8).

## Unit ID Settings

The Surveyor UV/Vis Plus Detector is shipped with the unit ID preset to 01 using the two rotary switches located on the back panel. The unit ID must match the Stack ID setting specified for the detector within the chromatography data system used to control it. You specify the Stack ID for the detector when you configure it for communication with your chromatography data system. The range of values for the unit ID is 01 to 99. The value of 00 is reserved for special service functions.

## Remote Communications Connections

The Surveyor UV/Vis Plus Detector has the remote communications inputs RUN and ZERO, and the remote communications output EVENT.

### RUN

The RUN input receives an inject signal from the autosampler, or from a manual injector, and sends a run-start signal to the PC-based software.

During installation, you must connect this UV/Vis detector RUN input to your autosampler or injector output. If your LC system contains a Surveyor Autosampler, you install the System Synchronization Wiring Harness (P/N F5049-010) to accomplish this task.

For Thermo Scientific autosamplers (other than the Surveyor Autosampler), connect the UV/Vis detector RUN input to the autosampler Inject Out output, and connect the UV/Vis detector GND terminal to the autosampler ground terminal.

For other autosamplers or injectors, first determine whether the device uses a TTL signal or a relay (a contact-closure), to remotely trigger detectors. Refer to the autosampler or injector documentation to determine whether a TTL signal or relay is used. Then, wire the device to the UV/VIS detector, by doing one of the following:

- If the autosampler or injector uses a TTL signal to trigger the run, connect the TTL trigger to the detector RUN terminal, and connect the signal ground terminal (or TTL return terminal) to the detector GND terminal.

## 2 Installation

### Making Initial Rear Panel Connections

- If the autosampler or injector device output relay consists of a single, normally-open terminal and a common ground terminal, connect the normally-open terminal to the detector RUN terminal, and connect the common ground terminal to the detector GND terminal. If both of the relay contacts are electrically isolated from each other and from ground (the device simply closes a contact between the two relay terminals), then connect either one of the relay terminals to the detector RUN terminal, and connect the other relay terminal to the detector GND terminal.

**Note** The detector ground (GND) terminals (pins 1 and 7) on the rear of the detector are tied to a single digital ground. You can use either ground terminal for digital input or output return connections.

## ZERO

The UV/Vis detector ZERO connector on the rear panel of the detector is used to zero the detector signal output from a remote device (generally at the start or end of each sample run).

The UV/VIS detector can be zeroed remotely with either a TTL low signal or with a contact closure.

During installation, you must connect this UV/Vis detector ZERO input to your remote device output. When the Surveyor UV/Vis Plus Detector is used with the Surveyor Autosampler, use the System Synchronization Wiring Harness (P/N F5049-010) to make this connection.

First determine whether the external device uses a TTL signal or a relay to remotely trigger detectors. Refer to the injector documentation of the external device to determine whether a TTL signal or relay is used. Then wire the device to the UV/VIS detector, using the appropriate procedure:

- If the external device uses a TTL signal to zero the detector, connect the TTL trigger to the detector ZERO terminal, and connect the signal ground terminal (or TTL return terminal) to the detector GND terminal.
- If the external device uses a relay to zero the detector, connect the normally-open terminal to the detector ZERO terminal, and connect the common ground terminal to the detector GND terminal. If the relay contacts are electrically isolated from each other (and from ground), then connect either one of the relay terminals to the detector ZERO terminal, and connect the other relay terminal to the detector GND terminal.

## EVENT

The UV/Vis detector EVENT output connector is used to trigger an external device such as a fraction collector.

If the external device is triggered by a contact closure, connect the UV/Vis detector EVENT terminal (pin 8) to the positive pin on the external device input, and connect one of the UV/Vis detector GND terminals (pin 1 or 7) to the external device negative pin.

**Note** The external device Input terminal might not have markings indicating positive and negative polarity. In this case, connect the UV/VIS EVENT terminal to one of the pins, and connect a UV/VIS GND terminal to the other pin.

If the external device is triggered using a TTL signal, connect the +5 V Output (pin 2) to the positive Input terminal of the external device, and connect the UV/Vis detector EVENT Output (pin 8) to the negative Input terminal of the external device.

## Connecting and Installing the Flow Cell

The Surveyor UV/Vis ships in any of three configurations, as listed in [Table 2](#).

**Table 2.** Shippable configurations of the Surveyor UV/Vis Plus Detector

Part Number	Configuration
Surveyor-UV0	with no flow cell
Surveyor-UV1	with 10 mm Standard Analytical flow cell
Surveyor-UV5	with 50 mm LightPipe flow cell

The standard analytical flow cell comes already installed in your detector. For more information on the standard analytical flow cell, see [‘Standard Analytical Flow Cell’](#).

The LightPipe flow cell comes packed in a small, separate box within the shipping carton for the detector. This small box contains the LightPipe flow cell (with protective caps on each end) and a plastic bag containing the inlet and outlet tubing and FingerTight fittings. Unpack the flow cell and install it as described in [‘LightPipe Flow Cell’](#).

Optional flow cells can be installed on the Surveyor UV/Vis Plus Detector configurations, according to the directions included in their packaging. See [Table 3](#) for a list of available optional flow cells.

## 2 Installation

### Powering On the Detector for the First Time

**Table 3.** Optional flow cells for the UV/Vis detector

Part Number	Flow cell Type	Pathlength (mm)	Volume (μL)
9550-0103S	Kel-F Bio Cell	6	9.0
9550-0101S	3 mm Semi-Prep	3	4.5
9550-0100S	6 mm Analytical	6	9.0
9550-0150-01S	High Pressure Microbore	2	.25
9550-0197S	Titanium Bio Cell	6	9.0
9550-053S	3 mm Microbore	3	1.2
9550-0234S	10 mm Analytical (Standard on Surveyor-UV1)	10	15
9550-0265S	6 mm Microbore	6	5.0
9550-0263S	Cuvette Holder		
9550-0267S	High Pressure Standard	6	9.0
803237	50 mm LightPipe (Requires F3005-010 LightPipe mounting assembly)	50	10

Most of the flow cells listed in [Table 3](#) require flow cell cover P/N 60053-40005. The 50 mm LightPipe (P/N 803237) requires flow cell cover P/N 60053-40004. The High Pressure Microbore flow cell requires flow cell cover P/N 60053-40006.

## Powering On the Detector for the First Time

After you have installed the flow cell, the detector is ready to be powered on.

### ❖ To power on the detector for the first time

1. Ensure that the power switch at the front of the unit is in the Off position (released or out position).

**IMPORTANT** If you are using a previous version of the LightPipe flow cell that has natural PEEK end caps, never turn the power on without the flow cell cover in place. When the instrument is powered on, it performs its Start-up diagnostics. Ambient light can affect these diagnostics.

**IMPORTANT** Do not operate the instrument in the Run or Preview Run mode before you install the flow cell cover, which minimizes thermal fluctuations.

2. Attach the power cord to the power entry module on the rear panel of the detector and connect it to the power source.
3. Turn the power on by pushing the power button in to engage it.

When the instrument is powered on, it performs its Start-up diagnostics. After a few seconds, the LEDs on the front of the detector turn solid green. If one or more LEDs flash green or amber, or turn solid amber, there might be a problem. The COMM LED remains amber until the software is started and initiates communication with the detector.

See [Chapter 4, “Troubleshooting,”](#) for a complete description of LED status indications. Call your Thermo Fisher Scientific Service Representative if you require assistance.



# Maintenance

This chapter describes the maintenance procedures that you must perform to ensure optimum performance of the UV/Vis detector.

The performance of your Surveyor UV/Vis Plus Detector depends on the maintenance of all parts of the detector. It is your responsibility to maintain your UV/Vis detector by properly performing the maintenance procedures on a regular basis.

Procedures described in this chapter are to be performed only by personnel trained in the service and maintenance of this instrument. If you have any questions on proper maintenance, or would like to arrange for a preventive maintenance program, please contact your Thermo Fisher Scientific representative.

## Contents

- [Recommendations for Routine Maintenance](#)
- [Tools Required](#)
- [Cleaning Detector External Surfaces](#)
- [LightPipe Flow Cell](#)
- [Standard Analytical Flow Cell](#)
- [Cleaning Flow Cells](#)
- [Replacing the Lamps](#)

## Recommendations for Routine Maintenance

Table 4 lists recommendations for routine maintenance of the Surveyor UV/Vis Plus Detector. Use this table as a basis for developing your maintenance program in accordance with the practices at your company.

**Table 4.** Recommended Routine Maintenance

Procedure	Interval
Exterior Detector Housing Cleaning	As needed
Flow Cell Cleaning	As needed*
Lamp Replacement	
a. (D <sub>2</sub> ) Deuterium	a. Every 1000 h or as required
b. (W) Tungsten	b. Every 2500 h or as required

\* Good laboratory practices dictate that the flow cell should be flushed with clean solvent after every use. This will greatly reduce the frequency with which you need to clean it.

## Tools Required

The following tools are required for the maintenance procedures in this chapter:

- narrow-tip, flat-bladed screwdriver (2 mm wide)
- #2 Phillips screwdriver
- 1/4-in. open end wrench
- 1/8-in. hex wrench (supplied)
- 3/32-in. hex wrench (supplied)
- 9/64-in. hex wrench (supplied)

## Cleaning Detector External Surfaces

The external surfaces of the detector should be kept clean and dry. To clean the outside of the detector, wipe it with a dust-free cloth or a damp cloth (moistened with water only) to remove dirt or stains.



## LightPipe Flow Cell

This section describes how to remove the LightPipe flow cell from, and install the flow cell in, the UV/Vis detector. Contact your Thermo Fisher Scientific Service Representative if you have any questions regarding LightPipe maintenance or replacement.

This section contains the following topics:

- [Removing the LightPipe Flow Cell](#)
- [Storing the LightPipe Flow Cell](#)
- [Installing the LightPipe Mounting Assembly](#)
- [Installing the LightPipe Flow Cell](#)



**CAUTION** Do not disassemble the LightPipe housing or tighten the screws on the housing. Doing so will damage the LightPipe flowcell. Thermo Fisher Scientific cannot be held responsible for any damage done to the LightPipe by attempts to disassemble the housing or to tighten the screws. Please contact your Thermo Fisher Scientific Service Representative with any questions regarding LightPipe maintenance or service.

## Removing the LightPipe Flow Cell

### ❖ To remove the LightPipe from the mounting assembly

1. Open the front doors of the detector.
2. Use a 1/8-in. Hex wrench (supplied) to unscrew the LightPipe cover retention screw. Then, remove the LightPipe cover. See [Figure 9](#).

**Figure 9.** Surveyor UV/Vis Plus Detector with the LightPipe and lamp covers on

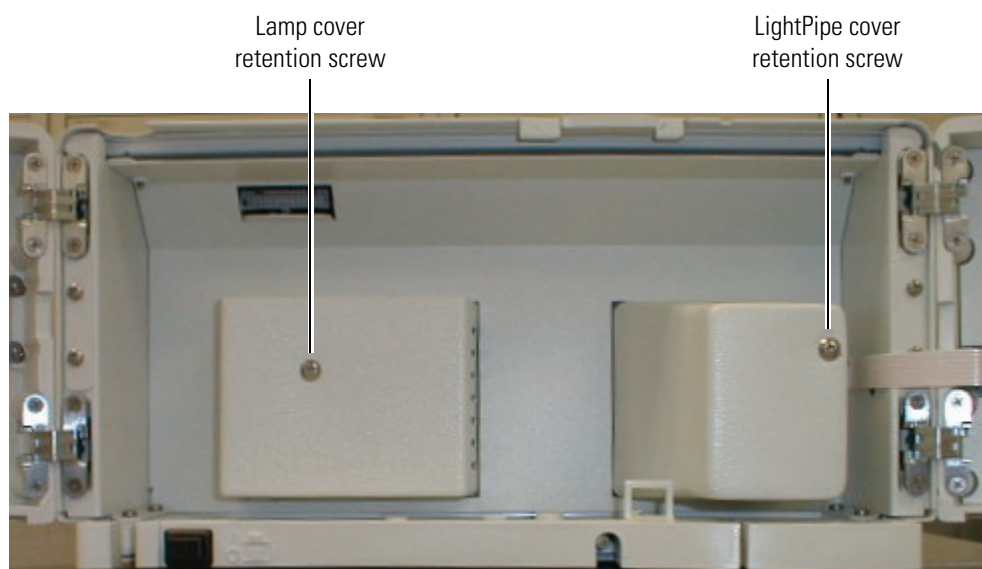



**CAUTION** Do not touch the surface of the photodiode. When removing the photodiode mount, be sure to place the mount where the photodiode will not get dirty or scratched.

3. Loosen and remove the two photodiode mount retention screws using the 3/32-in. hex wrench (supplied). See [Figure 10](#).
4. Carefully pull the photodiode mount straight back and off the LightPipe mounting assembly. Rest the photodiode mount out of the way inside the detector housing or on the benchtop.

**Figure 10.** Photodiode assembly, showing two mounting screws

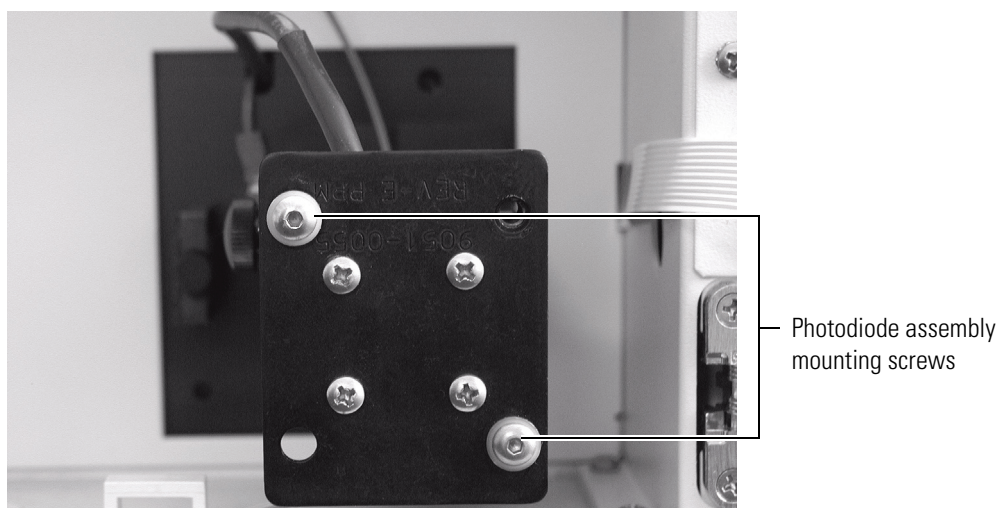

5. Loosen the thumbscrew holding the retention block to the LightPipe retention bar. See [Figure 11](#).
6. Lift the retention bar shown in [Figure 12](#) until the bar is clear of the alignment notch in the LightPipe.
7. Carefully remove the LightPipe from the LightPipe mounting assembly without touching the ends of the LightPipe.



**CAUTION** Do not touch the ends of the LightPipe flow cell. This could damage the sensitive fiber optics. See [Figure 12](#). If you must grasp the ends of the LightPipe flow cell to remove it from the assembly, use clean, talc-free gloves.

**Figure 11.** LightPipe mounting assembly, showing retaining block

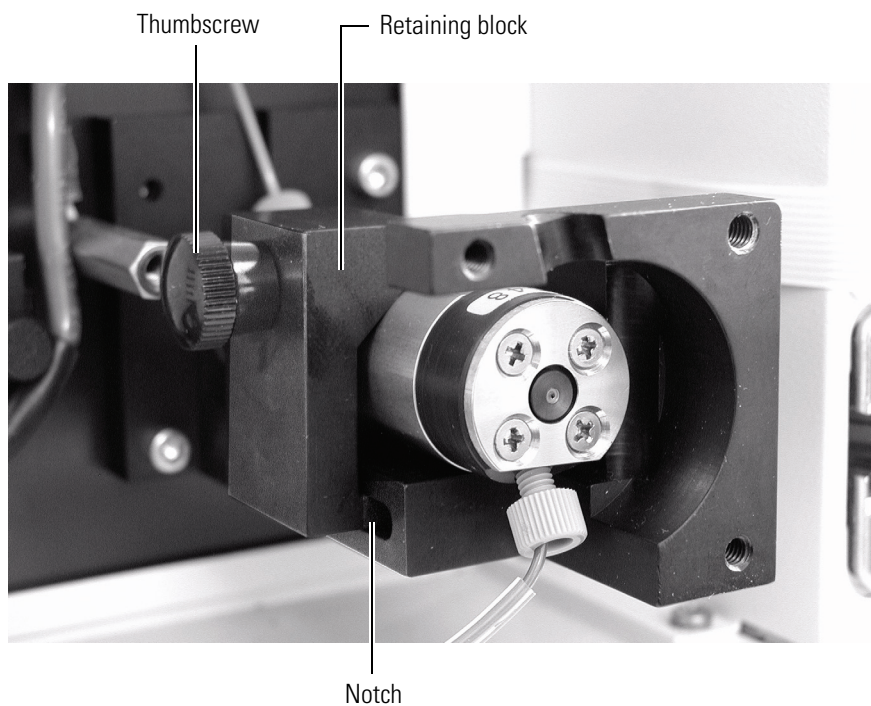

**Figure 12.** LightPipe mounting assembly, showing retention bar

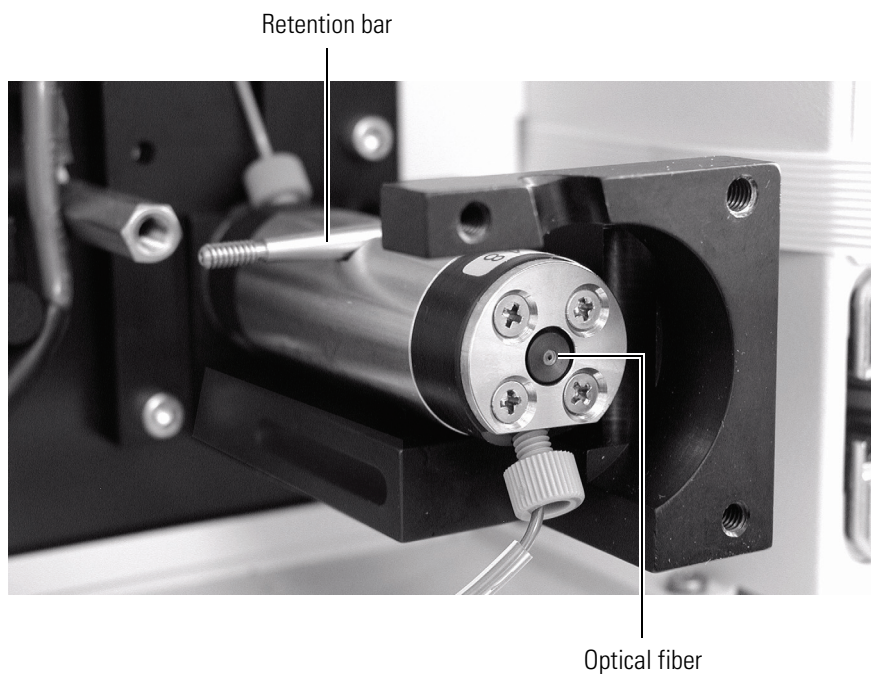

## Storing the LightPipe Flow Cell

❖ **To store the LightPipe flow cell**

1. Remove the FingerTight fittings and any attached tubing.
2. Immediately replace the protective end caps on the ends of the LightPipe to protect the sensitive fiber optics. See [Figure 13](#).

**Figure 13.** LightPipe flow cell with protective end caps, ready for storage



## Installing the LightPipe Mounting Assembly

If you are replacing a standard analytical flow cell with a LightPipe flow cell, you will need to install the LightPipe mounting assembly in the detector.

❖ **To install the LightPipe mounting assembly**

1. Remove the current flow cell. See [“Removing the Standard Flow Cell Assembly”](#) on [page 27](#) for instructions on removing the standard flow cell.
2. Carefully align the two holes in the mounting assembly with the mounting screw holes in the detector housing.
3. Ensure that you can swing the retention bar forward into the body of the mounting assembly. See [Figure 14](#).
4. Using the 9/64-in. hex driver (supplied), screw the two LightPipe mounting assembly screws into the detector. Do not overtighten the screws.

**Figure 14.** LightPipe mounting assembly shown attached to detector

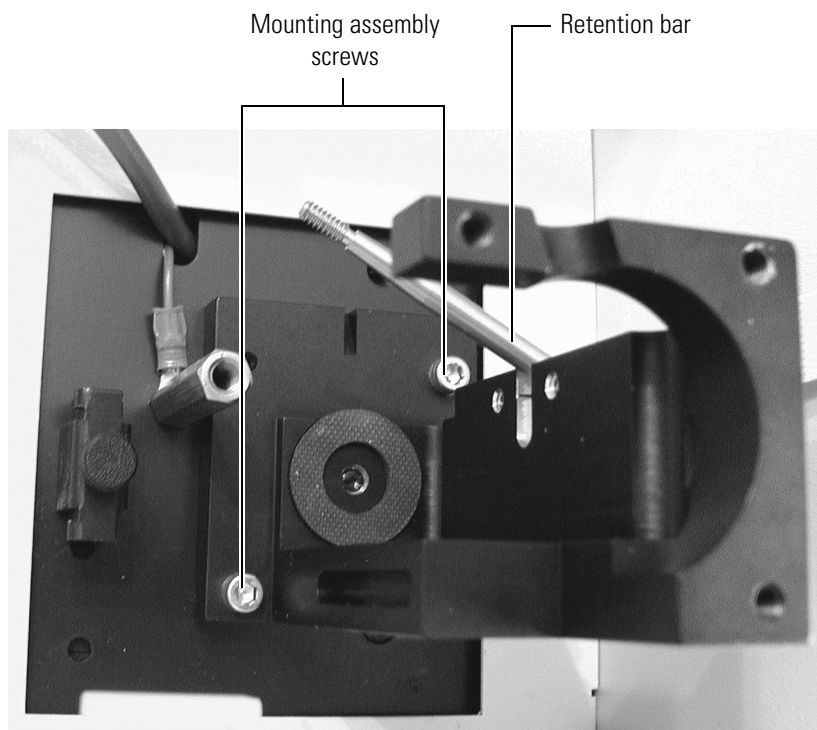

## Installing the LightPipe Flow Cell

The LightPipe flow cell assembly contains the parts listed in [Table 5](#).

**Table 5.** Parts for LightPipe flow cell assembly

Part Number	Description
803237	Flow cell Assembly, with inlet/outlet tubing and fittings (5 cm LightPipe)
2522-0285	FingerTight PEEK Ferrule Nuts
803260	Inlet tubing, with insulation, PEEK 1/16 x 0.005-in. ID (RED)
703950	Outlet tubing, PEEK 1/16 x 0.01-in. ID (Blue)

### ❖ To install the LightPipe in the mounting assembly

1. If the photodiode mount is attached to the end of the LightPipe mounting assembly, detach it as follows.
  - a. Loosen and remove the two photodiode mount retention screws ([Figure 10](#)) by using the 3/32-in. hex wrench (supplied).
  - b. Carefully pull the photodiode mount straight back and off the LightPipe mounting assembly. Place the photodiode mount out of the way inside the detector housing or on the benchtop.



2. Remove the protective end caps from the ends of the LightPipe.

**CAUTION** Do not touch the ends of the LightPipe. This could damage the sensitive optics. If you must grasp the ends of the LightPipe to remove it from the assembly, use clean, talc-free gloves.

3. Using the supplied fittings, attach the inlet tubing and the outlet tubing to the flow cell as follows:
  - a. Connect the insulated red PEEK™ inlet tubing to the port in the bottom of the flow cell.
  - b. Connect the blue PEEK outlet tubing to the port in the top of the flow cell.
4. Being careful not to touch the ends of the flow cell, hold the flow cell with the alignment slot facing upward as you insert it into the mounting assembly.
5. Secure the flow cell in the mounting assembly as follows:
  - a. Pull the retention bar down over the alignment slot in the flow cell (Figure 12).
  - b. Align the retaining block with the notch in the base of the assembly.
  - c. Slide the thumbscrew onto the retention bar. Then, push the retaining block firmly against the flow cell and tighten the thumbscrew finger tight (Figure 11).
6. Reattach the photodiode mount as follows:
  - a. Carefully align the holes in the photodiode mount with the holes in the LightPipe mounting assembly. Be careful not to touch the photodiode while manipulating the photodiode mount.
  - b. Screw in and tighten the two photodiode mount retention screws (Figure 10) using the 3/32-in. hex wrench (supplied).

**IMPORTANT** To ensure optimum performance, do not run the Surveyor UV/Vis Plus Detector without replacing the LightPipe cover. The LightPipe cover minimizes thermal fluctuations. If you are using a previous generation LightPipe flow cell that has natural PEEK end caps, install the flow cell cover before you power on the detector.

7. Guide the tubing through the slots in the top and bottom of the flow cell compartment cover. Then secure the cover by screwing in the LightPipe cover retention screw (see Figure 9) with the 1/8-in. hex wrench (supplied).
8. Connect the free end of the inlet tubing to the outlet of the LC column.
9. Close the front doors of the detector.
10. Before you start the pump flow, ensure that the outlet tubing drains to the waste reservoir.

## Standard Analytical Flow Cell

This topic describes the removal and installation of the standard analytical flow cell. For other flow cell problems, such as a cracked window or leaks that occur in locations other than at the inlet/outlet fittings, contact your Thermo Fisher Scientific Service Representative.

This section contains the following topics:

- [Removing the Standard Flow Cell Assembly](#)
- [Installing the Standard Analytical Flow Cell](#)



**CAUTION** Flow cells are factory-assembled units that should not be disassembled for any reason.

### Removing the Standard Flow Cell Assembly

To clean or replace the flow cell, you need to remove it from the UV/Vis detector.

#### ❖ To remove the flow cell

1. Turn off the power to the detector power and disconnect the power cord from the rear panel of the detector.
2. Open the front doors of the detector.

The flow cell assembly is located behind the flow cell cover.

3. Remove the flow cell cover by unscrewing the flow cell cover retention screw and pulling it straight out and away from the flow cell assembly. See [Figure 15](#).

**Figure 15.** Surveyor UV/Vis Plus Detector with the flow cell cover installed

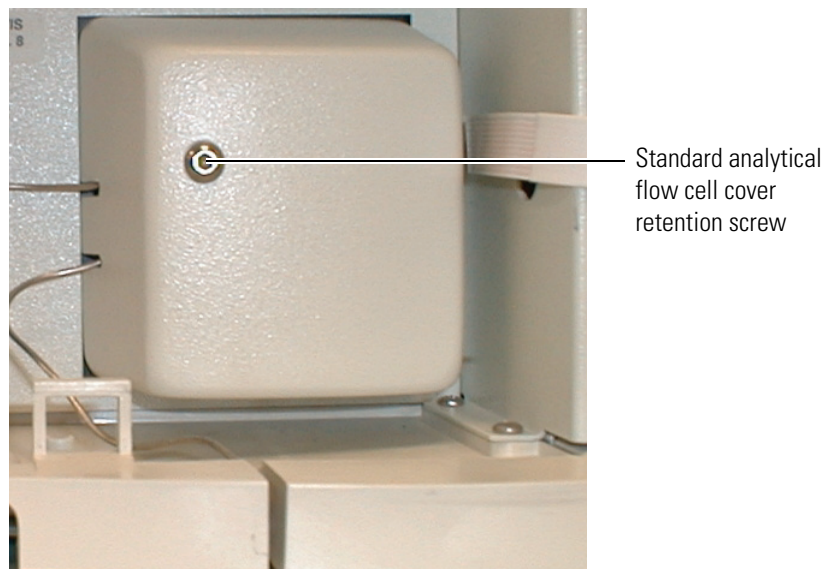

### 3 Maintenance

#### Standard Analytical Flow Cell

4. Loosen and remove the two photodiode mount retention screws. See [Figure 16](#).
5. Carefully pull the photodiode mount straight back and off the flow cell assembly. Rest the photodiode mount out of the way inside the detector housing or on the benchtop. See [Figure 17](#).
6. To free the tubing from the UV/Vis detector, remove the thumbscrew that holds the tubing retainer bracket to the UV/Vis detector.
7. Using the 9/64-in. hex driver (supplied), unscrew the two flow cell assembly mounting screws from the detector.
8. Carefully pull the assembly out of the UV/Vis detector and toward you to remove it from the detector.
9. If the flow cell needs to be completely removed from the system, disconnect the flow cell inlet tube from the column and disconnect the flow cell outlet tubing from the waste reservoir.

[Figure 17](#) shows the detector with the flow cell assembly removed.

**Figure 16.** Photodiode mount and tubing retainer bracket

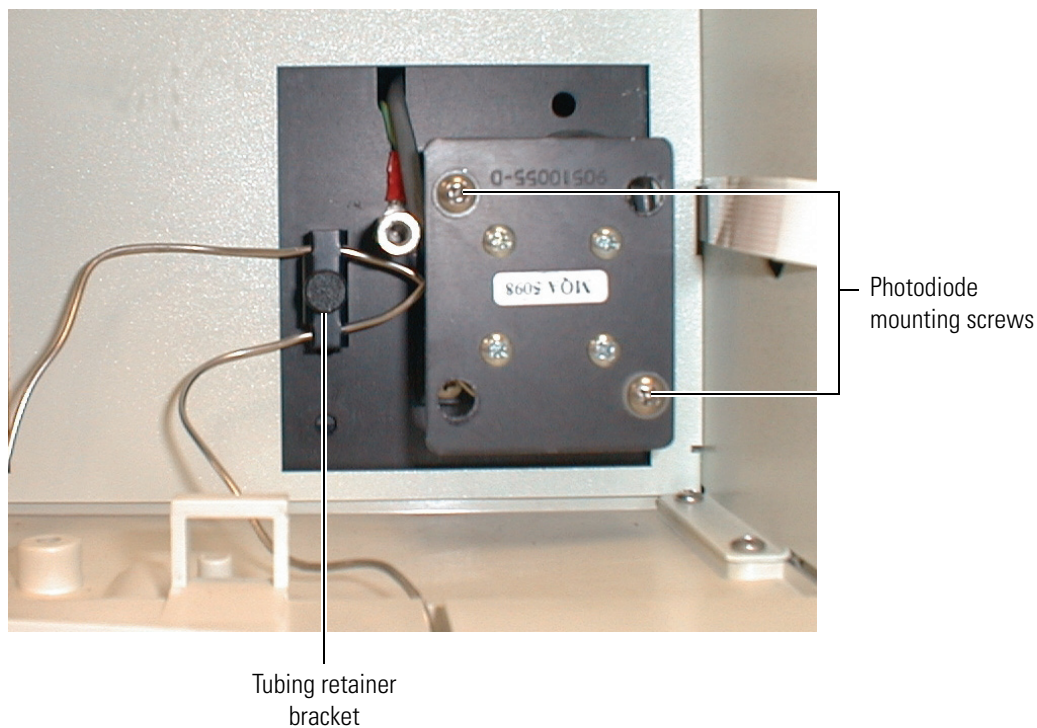



**Figure 17.** Surveyor UV/Vis Plus Detector with flow cell assembly removed

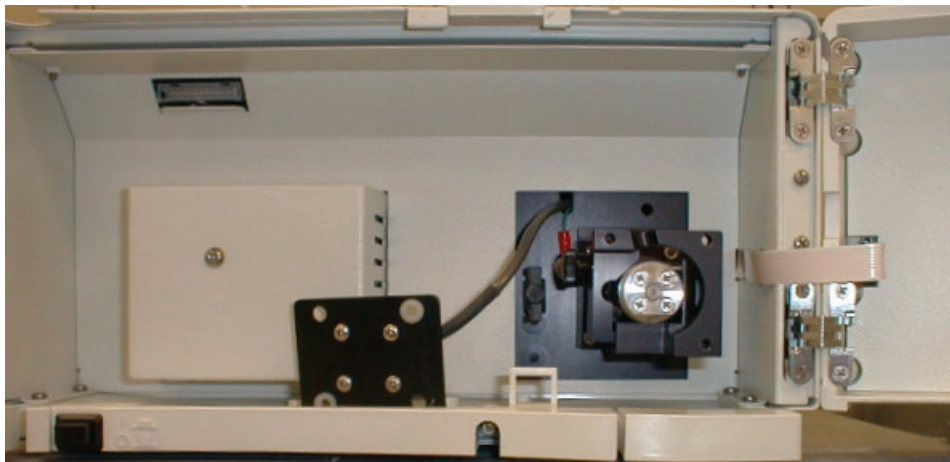

## Installing the Standard Analytical Flow Cell

### ❖ To install the standard analytical flow cell

1. With the inlet tube on the bottom left and the flow cell slot on top, slide the flow cell assembly into the detector and under the alignment pin.
2. Replace the two flow cell assembly mounting screws.
3. Align the photodiode mount with the flow cell assembly, so that the two holes with nylon washers align with the photodiode mounting posts on the flow cell assembly.
4. Install the two photodiode mount retention screws using the 9/64-in. hex driver.
5. Connect the inlet tubing to the chromatographic column and the outlet tubing to the waste reservoir.
6. Replace the tubing retainer bracket and tighten the thumbscrew just enough to hold the tubing in place.
7. Replace the standard analytical flow cell cover by guiding the tubing through the slots in the flow cell compartment cover and then securing the cover with the flow cell cover mounting screw.
8. Connect the power cord to the power entry module on the detector rear panel.

## Cleaning Flow Cells

The LightPipe and the standard analytical flow cell need to be cleaned to maintain optimum performance. Good laboratory practice dictates that you flush flow cells with clean solvent after every use. This practice keeps cell contamination at a minimum, but occasionally the exterior and/or interior surfaces of the flow cell can become contaminated. Flow cell contamination is usually caused by precipitation of salts or by solubility problems. Signs of a contaminated flow cell are increased baseline noise, signal spiking, erratic or drifting baselines, low light intensity and/or increased backpressure.

This section contains the following topics:

- [Cleaning with Organic Solvents](#)
- [Cleaning with Nitric Acid](#)

### Cleaning with Organic Solvents

If you suspect that your flow cell needs to be cleaned, start with the following procedure using organic solvents.

#### ❖ To clean the flow cell with organic solvents

1. Disconnect the column from the chromatographic system to avoid column degradation. Connect the flow cell inlet directly to the chromatographic pump.
2. Flush the cell with water to prevent a reaction between the last solvent used in the chromatographic system and the cleaning solvent that is going to be used.

**Note** Ensure that the cleaning solvent(s) you plan to use is miscible with the solvent already present in the flow cell and pump. Isopropanol is a good choice for most applications. If the last solvent in the pump was an aqueous buffer solution, be sure to pump 25 to 40 mL of HPLC-grade water (or equivalent) through the system to remove any salts *before* you flush the system with the cleaning solvent(s). This wash will help avoid salt precipitation problems.



**CAUTION** Thermo Fisher Scientific does not recommend using a syringe to force solvent through the flow cell. Pressurizing the syringe could cause a leak or rupture, resulting in a dangerous and uncontrolled spraying of solvent.

3. Flush the flow cell with 40 to 50 mL of cleaning solvent (HPLC-grade water, methanol, or isopropanol).
4. Flush the cell with water to prevent a reaction between the cleaning solvent and the mobile phase that is used in your application.

## Cleaning with Nitric Acid

Methanol or isopropanol is generally sufficient for cleaning a flow cell. However, if the flow cell remains contaminated after flushing it with organic solvents, perform the following procedure using nitric acid.

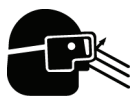

**CAUTION** Nitric acid is a strong oxidizing acid, and it can react vigorously with alcohols (especially methanol). Be sure to wear protective clothing and eye protection and adhere to your company's safety procedures for the proper handling and disposal of corrosive acids. Flush the flow cell with water to remove all traces of alcohol before flushing it with nitric acid.

### ❖ To clean the flow cell with nitric acid

1. Completely remove the flow cell assembly from the detector housing by following the procedure in [“Removing the LightPipe Flow Cell” on page 21](#) or [“Removing the Standard Flow Cell Assembly” on page 27](#). (This will prevent possible leaks from harming the mechanical and electronic components of the detector.)
2. Ensure that the column is removed from the chromatographic system to avoid column degradation. The flow cell inlet should be connected directly to the chromatographic pump.
3. This step is very important! Flush the cell with water to prevent a reaction between the last solvent used in the chromatographic system and the cleaning solution that is going to be used.
4. Prepare a 20% (vol/vol) solution of nitric acid in HPLC-grade water.



**CAUTION** Thermo Fisher Scientific does not recommend using a syringe to force acid solutions through the flow cell. Pressurizing the syringe could cause a leak or rupture, resulting in a dangerous and uncontrolled spraying of acid.



**CAUTION** Before you pump cleaning solutions through the flow cell:

- Ensure that the LC column has been removed from the chromatographic system.
- Ensure that water was the last solvent in the LC pump and solvent reservoir.

5. Pump the nitric acid solution through the flow cell using the chromatographic pump.
6. After you have finished the cleaning procedure, pump another 25 to 40 mL of water through the flow cell to remove all traces of nitric acid. Monitor the pH of the outlet stream of the flow cell to ensure that the acid has been completely flushed out.
7. See [“Installing the LightPipe Flow Cell” on page 25](#) or [“Installing the Standard Analytical Flow Cell” on page 29](#) to reinstall your flow cell.



**CAUTION** Flow cells are factory-assembled units that must not be disassembled under any circumstances. If you encounter contamination problems that cannot be remedied by using this cleaning procedure, contact your Thermo Fisher Scientific representative to arrange for repair or replacement of the flow cell.

## Replacing the Lamps

The Surveyor UV/Vis Plus Detector has two lamps, one tungsten (W) and one deuterium (D<sub>2</sub>). These lamps need to be properly cared for to maintain the optimum performance of your detector. Keep them clean and free from grease or fingerprints. Oils from your fingers that are left on the glass in the form of fingerprints can cause the lamps to fail. The lamps need to be warmed up before use. Typically, the warm up time needs to be at least 1.5 h to get the best performance from your detector.

**Note** When the instrument is turned on, the lamps are automatically ignited. If the lamps have been turned off, you need to load a method and wait for the lamps to warm up before you proceed with a run.

As the lamps age, there is a reduction in light output that results in increased baseline noise. If the noise level on the output signal of your detector is increasing and cleaning the flow cell does not help, you should change the appropriate lamp, using the procedures in this section. Be sure to replace only one lamp at a time to make operation verification easier.

**Note** The deuterium lamp has a lifetime of approximately 1000 h and the tungsten lamp has a lifetime of approximately 2500 h. Lamp lifetime varies depending upon the application.

To access the lamps, open the front doors of the detector. The deuterium and tungsten lamps are located in the housing on the left. The lamps are supplied pre-aligned in their individual assemblies to make them easy to install and align.

**IMPORTANT** Never loosen the screws that hold the lamp to its assembly or attempt to rotate or move the lamp up or down in the assembly. Either of these actions can cause a loss of alignment and degrade the system performance.

This section contains the following topics:

- [The Deuterium Lamp](#)
- [The Tungsten Lamp](#)

## The Deuterium Lamp

The deuterium (D<sub>2</sub>) lamp typically requires a warm-up time of twenty to thirty minutes. However, for applications that demand great sensitivity, you need to allow a warm-up period of 1.5 h.

**IMPORTANT** The intensity of the deuterium lamp falls off very slightly over a period of time after it is turned on. You should wait at least 1.5 h for the lamp to stabilize after a cold start before collecting data in the spectral range of the deuterium lamp.

The deuterium lamp lifetime is usually at least 1000 h. The deuterium lamp assembly is equipped with a chronometer that tracks the total hours of lamp operation. To read the chronometer, note the position of the “gap” in the mercury tube against the graduated background.

**IMPORTANT** The surfaces of both lamps must be kept free of fingerprints and smudges. For this reason, the lamps should only be handled with clean, talc-free gloves. If either lamp requires cleaning, clean with a lint-free lens paper moistened with methanol or isopropanol before replacing the lamp cover.

This topic contains the following subtopics:

- [Removing the Deuterium Lamp](#)
- [Installing the Deuterium Lamp](#)

### Removing the Deuterium Lamp

#### ❖ To remove the deuterium lamp

1. Disconnect the power cord from the detector rear panel and ensure that the instrument is turned off.
2. Open the front doors of the detector.



**CAUTION** Because intense UV light can damage your eyes, the detector automatically turns off the lamps when the lamp cover is removed. Because the lamps run hot, turn off the power and allow sufficient time (approximately 30 minutes) for the lamps to cool before you remove the lamp cover.

3. To remove the lamp cover, use an Allen wrench to unscrew the retention screw. See [Figure 18](#). Then pull the cover straight back to expose the lamp assemblies.

**Figure 18.** Surveyor UV/Vis Plus Detector showing the lamp cover retention screw

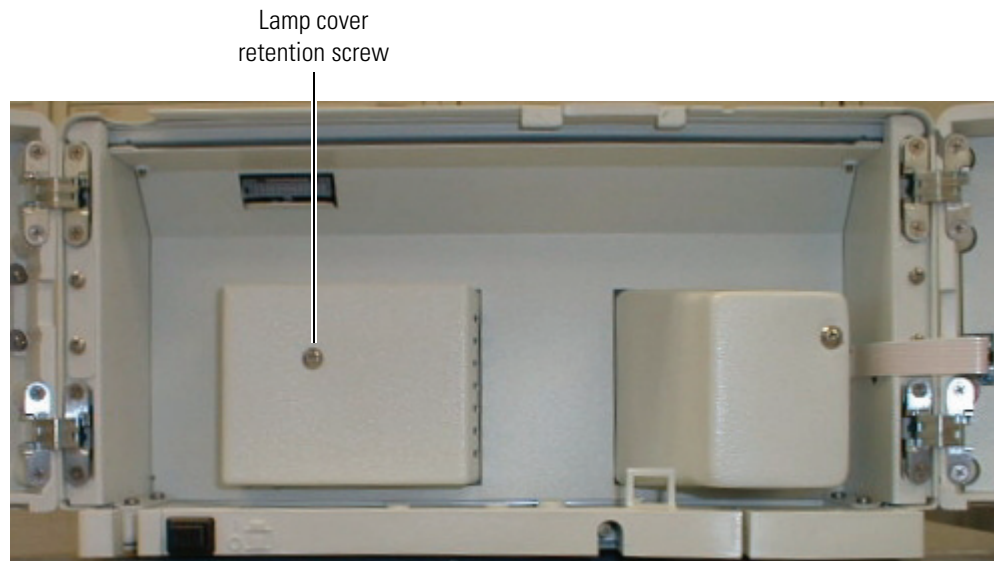

4. Unplug the deuterium lamp lead from the detector. See [Figure 19](#). Take care not to twist the connector as you gently pull it out.
5. Loosen the two thumbscrews that hold the lamp assembly in place and pull the assembly straight out.

**Figure 19.** Lamp housing removed

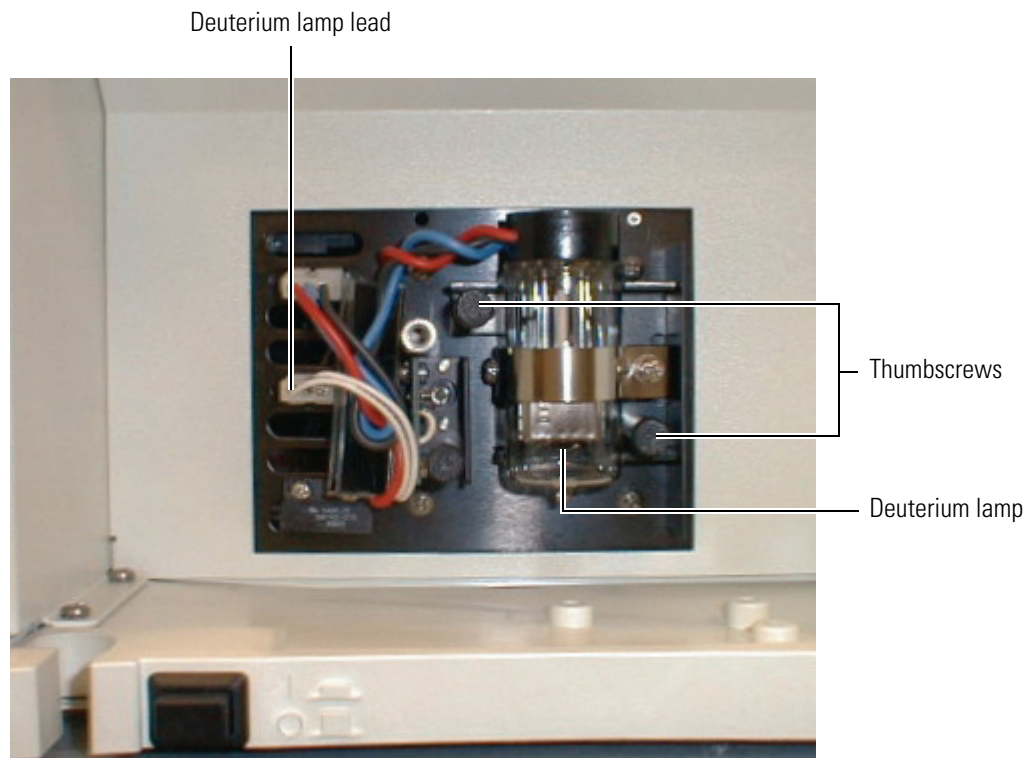

## Installing the Deuterium Lamp

### ❖ To install a new deuterium lamp

1. Hold the deuterium lamp assembly so that the leads are at the top. Slide the assembly onto the alignment pin shown in [Figure 20](#).
2. Securely fasten the assembly in place with the two thumbscrews and aluminum standoffs.
3. Connect the lamp lead to the upper terminal in the lamp compartment.
4. Replace the lamp housing and secure it with the screw. Close the front doors of the detector.
5. Connect the power cord to the rear panel of the detector.

**Figure 20.** Deuterium lamp assembly alignment pin

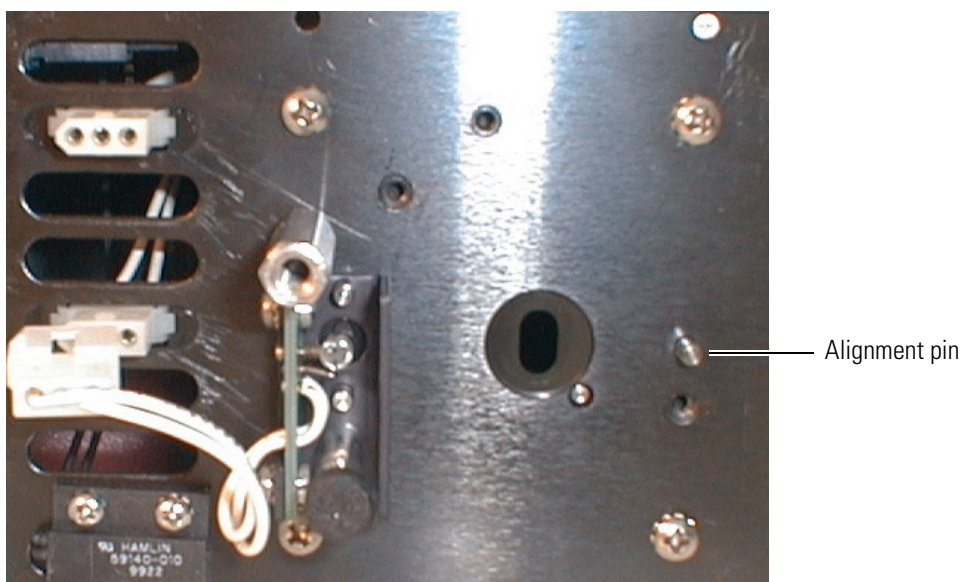

## The Tungsten Lamp

The tungsten (W) lamp typically requires only 15 min of warm-up time. Its lifetime is approximately 2500 h. An increase in noise can indicate that the lamp needs to be replaced.

This topic contains the following subtopics:

- [Removing the Tungsten Lamp](#)
- [Installing the Tungsten Lamp](#)

**IMPORTANT** The surfaces of both lamps must be kept free of fingerprints and smudges. For this reason, the lamps should only be handled with clean, talc-free gloves. If either lamp requires cleaning, clean with a lint-free lens paper moistened with methanol or isopropanol before replacing the lamp cover.

## Removing the Tungsten Lamp

❖ **To remove the tungsten lamp**

1. Turn the detector off and disconnect the power cord from the rear panel of the detector.



**CAUTION** To avoid burning yourself, always allow sufficient time (approximately 30 min) for the lamp to cool before removing it.

2. Remove the lamp housing by removing the lamp cover retention screw (see [Figure 18](#)) and pulling the cover straight back to expose the lamp assembly.
3. Unplug the tungsten lamp lead from the detector, taking care not to twist the connector as you gently pull it out. See [Figure 21](#).
4. Loosen the thumbscrew and the aluminum standoff that hold the lamp assembly in place.
5. Pull the assembly straight out to remove it from the detector.

**Figure 21.** Detector with lamp cover removed, showing the tungsten lamp assembly

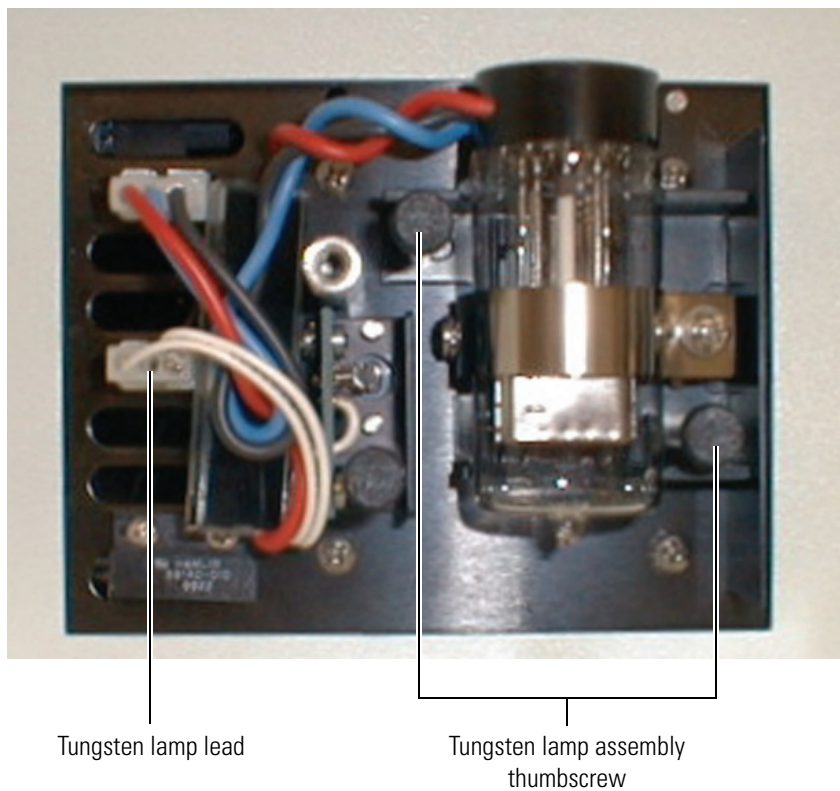



## Installing the Tungsten Lamp

### ❖ To install the tungsten lamp

1. Hold the lamp assembly so that the leads are at the top. Slide the assembly onto the two alignment pins shown in [Figure 22](#). The alignment pins are located on either side of the detector monochromator aperture.
2. Securely fasten the assembly in place with the thumbscrew and aluminum standoff.
3. Connect the lamp lead to the lower terminal in the lamp compartment.
4. Replace the lamp housing and fasten it securely with the screw.
5. Connect the power cord to the rear panel of the detector.

**Figure 22.** Tungsten lamp removed

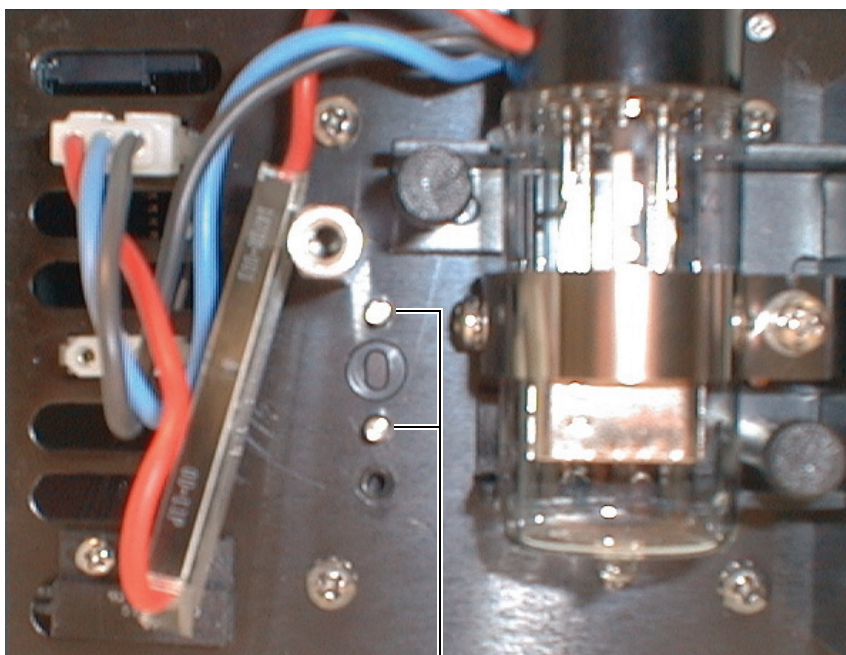

Alignment pins



# Troubleshooting

This chapter provides information for troubleshooting possible detector and chromatographic system problems. The information is organized in a table of symptoms, possible causes, and remedies. Because many of the problems attributed to the detector might actually be due to other components in the chromatographic system, references and potential solutions to these types of problems have also been included. Some common error messages and numeric codes are included to aid in troubleshooting errors.

## Contents

- [Detector-Related Problems](#)
- [Error Messages](#)

## Detector-Related Problems

Table 6 lists detector-related problems along with suggestions for corrective action.

**Table 6.** Troubleshooting detector-related problems (Sheet 1 of 5)

Symptom	Cause	Remedy
1. Spikes on baseline.	a. Continuous gas bubbles in the flow cell.	a. Degas mobile phase. Connect backpressure device to flow cell (check backpressure rating).
	b. Immiscible solvent bubbles following mobile phase changeover.	b. Flush flow cell with isopropanol, then with mobile phase.
	c. Electrical interference.	c. Check electrical lines for good connections and/or interference from broadcast radiation. Check for ground loops.
	d. Extremely large fluctuations in voltage on POWER line.	d. Remove systems (for example, ovens) that cause voltage fluctuations, isolate the detector to a “quiet” circuit, or use UPS (Uninterruptible Power Supply).
	e. Ambient light.	e. Install flowcell cover. Flowcell cover must be installed before power On and must not be removed during Run and Preview Run operation.

**Table 6.** Troubleshooting detector-related problems (Sheet 2 of 5)

Symptom	Cause	Remedy
2. Random noisy baseline.	a. Contaminated flow cell.	a. Flush flow cell with cleaning solvents as described in “ <a href="#">Cleaning Flow Cells</a> ” on page 30. Check for leaks.
	b. Leak in sample inlet line.	b. Check all fittings from column outlet to flow cell inlet for leaks.
	c. Bubble trapped in flow cell.	c. Increase flow rate until bubble is removed. Supply backpressure device to flow cell (check pressure rating to avoid rupturing flow cell).
	d. Leaking flow cell.	d. Replace flow cell.
	e. Insufficient lamp warm-up.	e. Allow a 30 min warm-up for normal operation and 1.5 h for maximum sensitivity.
	f. Lamp aging or defective.	f. Replace lamp.
	g. Ground loop problem between integrator and detector.	g. Check for proper cable connections for detector output; do not ground at both ends of cable.
	h. Flow cell or lamps dirty.	h. Clean dirty component as described in “ <a href="#">Cleaning Flow Cells</a> ” on page 30.
	i. Integrator input voltage does not match detector output voltage.	i. Verify integrator connected to appropriate Analog Output connections on the detector. See “ <a href="#">Analog Output Connections</a> ” on page 11. Check attenuation setting on integrator.

**Table 6.** Troubleshooting detector-related problems (Sheet 3 of 5)

Symptom	Cause	Remedy
3. Excessive baseline drift Drift.	a. Flow cell contaminated.	a. Flush flow cell with cleaning solvents as described in “ <a href="#">Cleaning Flow Cells</a> ” on page 30. Check for leaks.
	b. Mobile phase contamination.	b. Replace with fresh mobile phase made with high-purity solvents.
	c. Material bleeding from column.	c. Clean or replace column.
	d. Leaks in system or flow cell.	d. Check all fittings for leaks. Replace flow cell.
	e. Tiny bubble trapped in flow cell.	e. Increase flow rate until bubble is removed. Connect backpressure device to flow cell outlet (check backpressure rating to avoid rupturing flow cell).
	f. Large temperature fluctuations.	f. Remove system from drafts. Thermostatically control column temperature.
4. No peaks, or peaks much smaller than expected.	a. Incorrect wavelength setting.	a. Check wavelength setting. Make sure the correct file is selected.
	b. Lamp not On, or defective.	b. Make sure lamp is On. Run detector diagnostic tests to check lamp. Replace lamp if necessary.
	c. Integrator input voltage does not match detector output voltage.	c. Verify integrator connected to appropriate Analog Output connections on detector. (See “ <a href="#">Analog Output Connections</a> ” on page 11.) Check attenuation setting on integrator.
	d. Insufficient sample reaching the detector.	d. Check entire system for leaks. Verify sample injection volume.

**Table 6.** Troubleshooting detector-related problems (Sheet 4 of 5)

Symptom	Cause	Remedy
5. Broad, tailing peaks.	a. Rise time is too large (too slow).	a. Lower the rise time selection.
	b. Poor connection at flow cell inlet.	b. Check end of inlet tubing for a clean, flat surface free of obstructions.
6. Detector will not power up.	a. Tripped circuit breaker at power outlet.	a. Resolve problem, reset circuit breaker.
	b. Blown detector fuse.	b. Resolve problem, replace fuse.
	c. Incorrect voltage selected.	c. Verify Voltage Selector installed for correct incoming line-voltage. (See “Checking the Power Setting and Fuses” on page 10.)
	d. Power cord not connected.	d. Connect power cord.
7. Detector does not go into run upon injection.	a. Detector not receiving Start signal.	a. Check connection to Run contacts on back panel.
8. LED1 - Power	a. Green - power On.	a. No action required.
	b. Off - no power.	b. Check fuse, line voltage, etc.
9. LED2 - Comm	a. Green - communications normal.	a. No action required.
	b. Amber - no communications with PC system.	b. Check Ethernet connections and start software, check module configuration in the software, reload firmware.
	c. Blinking Amber - firmware download in process or under serial control (stack ID set to 00).	c. Complete download and re-establish communications with PC, reset stack address to value other than 00.

**Table 6.** Troubleshooting detector-related problems (Sheet 5 of 5)

Symptom	Cause	Remedy
10. LED3 - Run	a. Flashing Green - run in progress.	a. No action required.
	b. Solid Green - ready.	b. No action required.
	c. Blinking Amber - an error has occurred while performing a run.	c. Refer to software to determine the nature of the error, or begin the run again.
11. LED4 - Lamps	a. Green - one or both lamps are On.	a. No action required.
	b. Amber - both lamps are Off.	b. Turn On lamps in software and allow 1.5 h for warm-up.

## Error Messages

Error messages are posted to the Status page of the data system that you are using to control your detector.

**Note** For further information, document the log entry and contact Thermo Fisher Scientific technical support.

Possible error messages include, but are not limited to, those listed in [Table 7](#).

**Table 7.** Possible error messages (Sheet 1 of 3)

Error Number	Meaning
2001	System reset
2002	System error (bus/address)
2004	Lamp case open
2011	Sample light is too high
2012	Low light on D2 lamp
2013	Low light on W lamp
2014	Volatile RAM test failed
2015	Non-Volatile RAM test failed
2016	12 volts failed
2017	12 volt unregulated failed
2018	-12 volts failed



**Table 7.** Possible error messages (Sheet 2 of 3)

<b>Error Number</b>	<b>Meaning</b>
2019	Motor voltage failed
2020	W lamp voltage or driver failed
2021	D2 lamp or driver failed
2022	5 volts failed
2023	Reference diode failed
2024	Sample diode failed (Could be exposed to light.)
2025	Wavelength home test failed
2026	Second wavelength home failed
2027	Analog linearity test failed
2028	D2 lamp failed / not present
2029	W lamp failed / not present
2030	Shutter failed
2031	Unknown shutter / lamp failure
2201	Invalid file number
2202	Invalid lamp state
2203	No replay while in a run
2205	Invalid current time
2206	Invalid lamp turn on time
2207	Invalid lamp turn off time
2208	Invalid time from ready time
2209	Invalid lamp on option
2210	Invalid lamp off option
2212	Invalid program time
2213	Invalid wavelength for program
2215	Invalid program type
2216	Invalid output range
2217	Invalid rise time filter
2218	Invalid auto zero time
2219	Invalid output range
2220	Invalid rise time filter
2221	Invalid run wavelength

**Table 7.** Possible error messages (Sheet 3 of 3)

<b>Error Number</b>	<b>Meaning</b>
2226	Invalid auto zero time
2227	Invalid rise time filter
2228	Invalid run time
2232	Invalid runs per wavelength
2234	Invalid offset
2235	Invalid zero on lambda change value
2236	Invalid channel 2 selection

## Accessories and Replaceable Parts

This chapter contains the lists of accessories and replaceable parts that can be ordered from Thermo Fisher Scientific.

### Contents

- [Replaceable Parts](#)
- [Optional Flow Cells for the UV/Vis Detector](#)

## Replaceable Parts

The following items are replaceable parts for the Surveyor UV/Vis Plus Detector:

Assembly, Power Entry w/switch. . . . .	F3030-010
Connector, external . . . . .	2110-0354
Cable, Converter Power . . . . .	60053-63002
Cable, Main - Analog PCB . . . . .	60053-63010
Cable, Main - Converter PCB . . . . .	60053-63012
Cable, deuterium lamp . . . . .	6040-0167
Cable, tungsten lamp . . . . .	6040-0168
Cable, Display LEDs . . . . .	F5025-010
Cuvette holder assembly . . . . .	9550-0263S
Cover, Lamps . . . . .	60053-40042
Cover, LightPipe. . . . .	60053-40041
Door, right, assembly . . . . .	60053-60068
Door, left assembly . . . . .	60053-60069
Fuse, slo-blo, for 230 V applications (T1.25 A) . . . . .	5101-1857
Fuse, slo-blo, for 100/115 V applications (T2.5 A) . . . . .	5101-1858
Housing assembly. . . . .	F3050-040S
Kit, accessory . . . . .	60053-62004
Lamp, tungsten. . . . .	9551-0022
Lamp, D2. . . . .	9551-0023
Transformer, main . . . . .	9551-0187-04
Patch Cable, RJ-45, Cat 5, shielded . . . . .	70111-63302
PCB, analog . . . . .	F9080-010
PCB, Converter . . . . .	F9060-060
PCB, Motherboard. . . . .	F9055-010
Photodiode, pre-amp assembly . . . . .	60053-63031
Screwdriver, Hex, ball-end, 1/8-in., black . . . . .	00725-00042

## 5 Accessories and Replaceable Parts

### Optional Flow Cells for the UV/Vis Detector

Screwdriver, Hex, ball-end, 9/64-in., black . . . . .	00725-00044
Screwdriver, Hex, ball-end, 3/32-in., black . . . . .	00725-00040
Solenoid, lamp shutter . . . . .	9551-0221
Switch, magnetic proximity . . . . .	5110-0058
Transformer, hi-voltage . . . . .	9551-0200

## Optional Flow Cells for the UV/Vis Detector

The following flow cells and flow cell covers can be ordered from Thermo Fisher Scientific:

Kel-F Bio Cell. . . . .	9550-0103S
3 mm Semi-Prep. . . . .	9550-0101S
6 mm Analytical . . . . .	9550-0100S
High Pressure Microbore . . . . .	9550-0150-01S
Titanium Bio Cell. . . . .	9550-0197S
3 mm Microbore . . . . .	9550-053S
10 mm Analytical (Standard on Surveyor-UV1) . . . . .	9550-0234S
6 mm Microbore . . . . .	9550-0265S
Cuvette Holder. . . . .	9550-0263S
High Pressure Standard. . . . .	9550-0267S
50 mm LightPipe (Requires F3005-010 LightPipe Mount) . . . . .	803237

Most of the above cells require flow cell cover P/N 60053-40005. The 50 mm LightPipe (P/N 803237) requires flow cell cover P/N 60053-40041. The High Pressure Microbore flow cell requires flow cell cover P/N 60053-40006.

## Surveyor Firmware Upgrade Utility

From time to time, upgrades to Surveyor UV/Vis Plus firmware might become available. If you need to upgrade the firmware, or to replace firmware that has become corrupted, you can do so by using the Surveyor Firmware Upgrade Utility. This appendix provides instructions on how to use the Surveyor Firmware Upgrade Utility.

### ❖ To download firmware using the Surveyor Firmware Upgrade Utility

1. From Windows Explorer locate the firmware files you intend to download (ROM\*.bin and UV\*.bin):
  - For ChromQuest, these files are located in the Firmware folder on the ChromQuest CD.
  - For Xcalibur, these files are located in the following folder:  
[drive]:\Xcalibur\system\Surveyor Firmware
2. Set the Unit ID on the back panel of the detector to the maintenance setting:
  - a. Ensure that the UV/Vis power is turned off.
  - b. Make a note of the current settings of the rotary switches on the back UV/Vis detector. You will return them to these positions at the conclusion of the procedure.
  - c. Set the switches of the UV/Vis to 00.
3. Ensure that your Surveyor UV/Vis Plus Detector is connected to your data system computer with the standard Ethernet connection.
4. Turn the power to the detector on.

The COMM LED blinks amber to confirm that the Surveyor UV/Vis Plus Detector is configured for downloading the firmware.

5. Start the Surveyor Firmware Upgrade Utility by double-clicking the Surveyor Firmware Upgrade Utility application. The Surveyor Firmware Upgrade Utility window opens. See [Figure 23](#).

6. In the Surveyor Firmware Upgrade Utility window, initiate communication between the utility and the Surveyor UV/Vis Plus Detector:

a. In the Device Type area, click the **Surveyor UV/Vis** option. See [Figure 23](#).



**CAUTION** Do **not** interrupt the firmware download process. Do **not** turn off the power to the Surveyor UV/Vis Plus Detector or close the Surveyor Firmware Upgrade Utility while the detector is connected to the Surveyor Firmware Upgrade Utility. If you lose power to the detector during the firmware download process, contact your Thermo Fisher Scientific representative. The firmware board will have to be reprogrammed.

b. Click **Connect**.

The status display at the bottom of the Surveyor Firmware Upgrade Utility window indicates that a connection has been made. See [Figure 24](#).

**Figure 23.** Surveyor Firmware Upgrade Utility, showing the Surveyor UV/Vis option selected

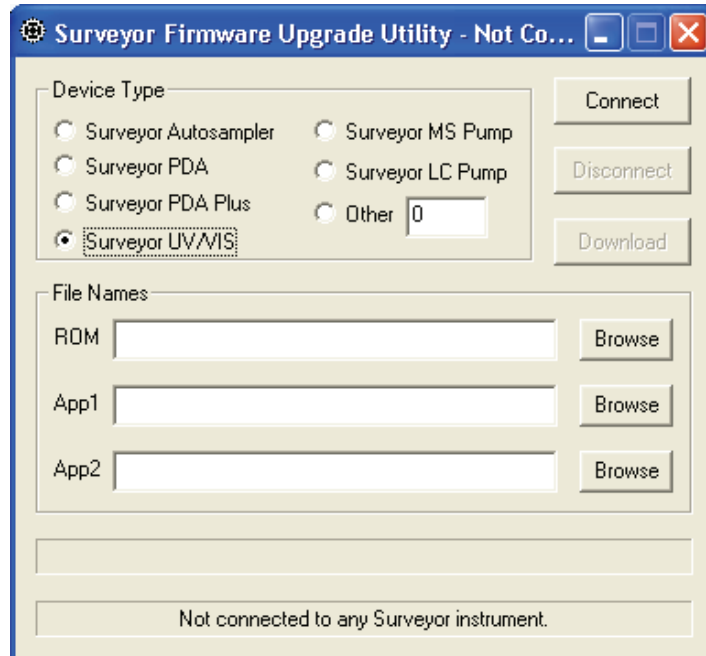

**Figure 24.** Surveyor Firmware Upgrade Utility showing a successful connection to the Surveyor UV/Vis Plus Detector

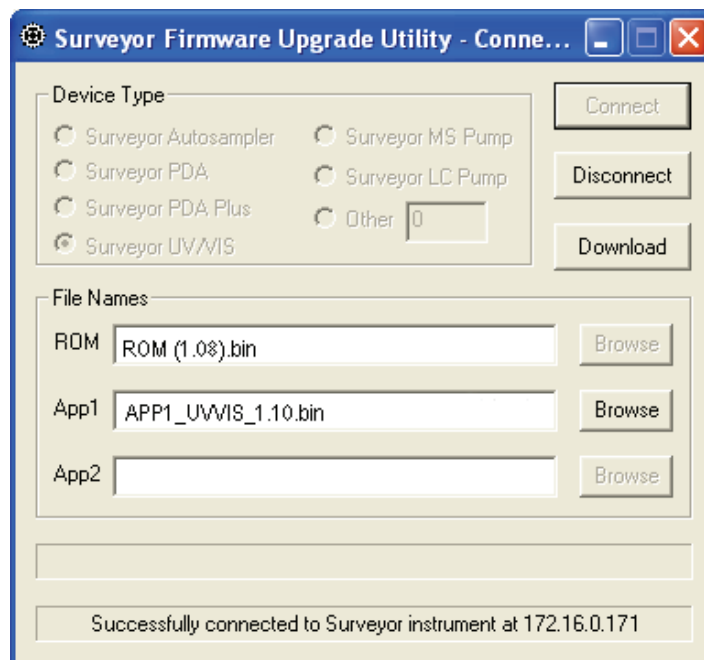

7. In the Surveyor Firmware Upgrade Utility window, select the appropriate firmware files for the Surveyor UV/Vis Detector:
  - a. In the File Names area, click **Browse** to the right of the ROM box, and then select the ROM file ("ROM\*.bin"). The filename appears in the ROM box. See [Figure 25](#).
  - b. In the File Names area, click **Browse** to the right of the APP1 box, and then select the APP1 file ("UV\*.bin"). The filename appears in the App1 box. See [Figure 25](#).

**IMPORTANT** You must select both a ROM file and an APP1 file. Your Surveyor UV/Vis Plus Detector will not work properly if the files are not downloaded together.

8. Click **Download**, and wait for the download to finish.

The utility notifies you when it completes the download. Once the download is complete, you can safely close the Surveyor Firmware Upgrade Utility and turn off the power to the detector.

9. Close the Surveyor Firmware Upgrade Utility. The connection with the Surveyor UV/Vis Plus Detector is terminated automatically.
10. Reset the Unit ID on the rear panel of your detector for normal operation:
  - a. Turn off the power to the UV/Vis detector.

**Note** It is important to turn the UV/Vis power off before adjusting the rotary switches.

- b. Set the rotary switches back to their original positions.

- c. Turn on the UV/Vis power to resume normal operation.

**Figure 25.** Surveyor Firmware Upgrade Utility showing the ROM\*.bin and UV\*.bin files selected

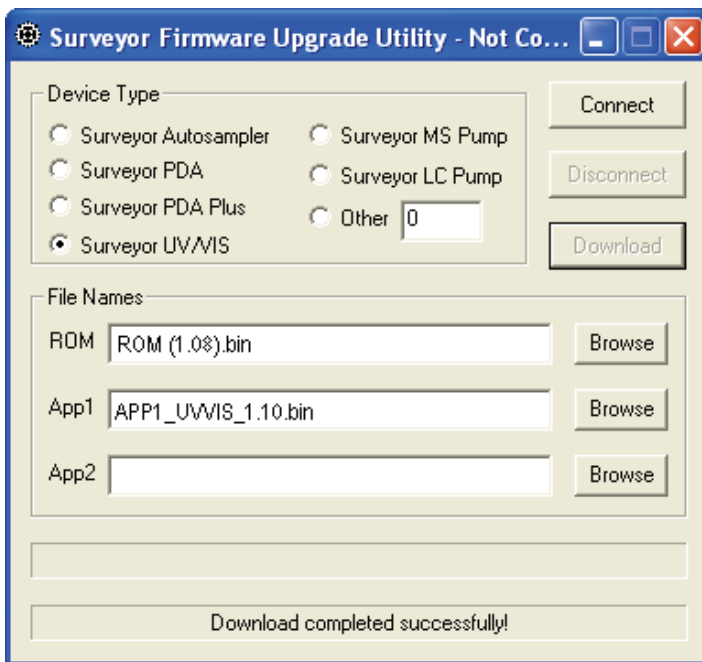



# Index

## A

- absorbance range 5
- ac line problems 40
- accessory kit 8
- alignment pins for deuterium lamp assembly (figure) 35
- analog outputs
  - full-scale settings 13
  - specifications 5

## B

- baseline problems
  - noise, causes of 41
  - spikes, causes of 40

## C

- Cautions
  - Do not touch the ends of the LightPipe flowcell 4
  - lamp assembly 32
- cell dimensions 5
- cell pressure rating 5
- chromatogram, output settings 13
- column bleed 42
- connections
  - analog output 11
  - Ethernet 11
  - remote communications inputs 13

## D

- d 37
- Deuterium lamp
  - lifetime 32
- deuterium lamp
  - installing 35
  - lifetime 32
  - removing 33
- dimensions 5
- drift 5
- drift, see baseline problems 42

## E

- electrical interference, causes of 40
- error messages, reference 44

## F

- Firmware downloads
  - cable connections 49
  - location of firmware files 49
  - Surveyor Firmware Upgrade Utility 49
- flow cell
  - bubbles in the 40, 41
  - cover (figure) 27
  - covers 48
  - installing the 29
  - leaks 41
  - location of 27
  - options 48
  - removing the 27
  - safety precautions when cleaning 31
  - schematic 3
- fuse holder removal 10
- fuse sizes 10

## G

- ground loop problems, causes of 41

## I

- initial power on 16
- installation
  - accessory kit 8
  - checklist 8
  - flow cell 29
  - positioning the detector 9
  - powering on 16
  - tools for 9
  - unpacking 8

## L

- lamp cover (figure) 34
- lamp housing (figure) 34
- lamps
  - cleaning the 33, 35
  - installing the deuterium lamp 35
  - installing the tungsten lamp 37
  - removing the deuterium lamp 33
  - removing the tungsten lamp 36

## LEDs

- Comm 43
- errors 43
- Lamps 44
- Power 43
- Run 44

## LightPipe

- installing 25
- ready for storage 24
- removing 21
- removing from assembly 21

## linearity 5

## M

### maintenance

- cleaning external surfaces 20
- cleaning flow cell 30
- installing flow cell 29
- overview 19
- removing flow cell 27
- routine maintenance recommendations 20

### maintenance tools 20

## N

### nitric acid

- safety precautions 31

### Notes

- lamp lifetimes 32
- lamp warm up 32
- lamps, cleaning the 33, 35

## O

- operating humidity 5
- operating temperature 5
- optical bench (figure) 2
- optical fiber (figure) 4

## P

- parts, replaceable 47

- peak problems
  - broadening 43
  - size 42
  - tailing 43

### photodiode mount (figure) 28

### positioning the detector 9

### power requirements 5

### product certification 5

## R

### remote controls 5

### rise time

- incorrect setting, results of 43
- settings 5

### rotary switches, unit ID settings 13

## S

### scan rate 5

### short term noise 5

### specifications 5

### spectral bandwidth 5

### stack address (note) 13

### storage temperature 5

### Surveyor UV/Vis

- installation 8
- optical bench 2

## T

### temperature fluctuations, results of 42

### tools

- needed for installation 9
- needed for maintenance 20

### troubleshooting

- error messages 44
- table of common problems 40

### troubleshooting guide, pump 40

### tungsten lamp 32

- installing 37
- lifetime 32
- removing 36

## U

### unit ID (note) 13

### unpacking your detector 8

### UPS, uninterruptable power supply 40

### UV/Vis, troubleshooting 40

**V**

- voltage
  - ac line problems 40
  - changing the setting 10
  - voltage selector 10

**W**

- warm-up 5
- wavelength accuracy 5
- wavelength range 5
- weight 5

