

HELIX SFT
Static Vacuum Mass Spectrometer



Static Vacuum **HELIX SFT**

Low Volume • Multicollection • High Mass Resolution

Thermo
SCIENTIFIC

Based on more than 20 years of experience in noble gas mass spectrometry instrumentation, we have developed the Thermo Scientific™ HELIX SFT™, our latest generation Static Vacuum Mass Spectrometer (SVMS).

It combines innovative new features with the field-proven technology taken from the Thermo Scientific isotope instruments. The HELIX SFT system is a major step forward in multicollector SVMS technology.

The HELIX SFT mass spectrometer is one member of a family of products designed to meet the requirements of the static vacuum community. The portfolio includes the ARGUS VI™ mass spectrometer, which is a high sensitivity, multi collector system designed predominantly as the ultimate tool for argon dating. The final product in the portfolio is the HELIX MC *Plus*™ mass spectrometer, which is designed to be the ultimate high resolution variable multi collector system. This instrument is capable of measuring any five isotopes of neon, argon, krypton or xenon simultaneously, at new levels of resolution.

Static Vacuum Mass Spectrometer

HELIX SFT

The HELIX Split Flight Tube mass spectrometer is a magnetic sector mass spectrometer designed for high precision isotopic analysis of small samples of the noble gases. It comprises a magnetic sector analyzer with 35 cm 120° extended geometry ion optics. The geometry combines excellent ion optic performance with two-direction focusing and high dispersion in a compact footprint.

Sensitivity

One of the key features of the HELIX SFT instrument is its very low internal volume of ~1400 cc. Given that the sensitivity of a static vacuum mass spectrometer is inversely proportional to its internal volume, the instrument has been designed taking great care to keep this at a minimum. Coupled to its low volume, the instrument utilizes a X & Z focused Nier type bright source, giving argon sensitivities in excess of 1×10^{-3} Amps / Torr at a source emission of less than 1 mA and helium sensitivities in excess of 2×10^{-4} Amps / Torr at a source emission of less than 1.2 mA.

Detection

The collector array incorporates an electrically suppressed Faraday detector on the high mass spur and a copper beryllium ion counting electron multiplier on the low mass spur. The low mass spur also incorporates a 5 cm 90 degree energy filter for excellent abundance sensitivity performance. The high mass Faraday cup incorporates new high gain amplifier circuits that allow for gains of 10^{10} , 10^{11} or 10^{12} Ohm measuring resistors to be utilized.

These temperature controlled evacuated amplifiers have an extended measurement range of 50 V, rather than the historical 10 V, giving the system an improved dynamic range.

The low mass spur multiplier is a high performance extended lifetime device. This discrete dynode (SEV217) electron multiplier has an ion counting efficiency > 70 % with inherent noise < 10 CPM. and has been designed specifically for very low out gassing rates.

This SEM device can either be used for single collector peak jumping measurements or in conjunction with the Faraday for simultaneous helium 3 / 4. This collector array, coupled to the flexible user definable software suite, allows for not only multicollection analysis or single collector measurements but also a mixture of both during the same run.



Analyzer

Ion Source

The HELIX SFT system utilizes a flange mounted “Nier” type ion source that has evolved in design over the last 30 years. This source gives excellent sensitivity while maintaining a low trap / total emission ratio leading to long filament life and low source temperatures. The source is designed for easy de-mount and filament change. The source is self-realigning on assembly.

- Self-aligning source filament
- Maximized ion production for high sensitivity
- Simple design, easy to maintain

Electromagnet

The electromagnet is fabricated from high purity soft iron. It is mounted on roller bearings and has translational and rotational adjustment in all three planes to optimize peak shape and flatness.

- High stability achieved with a temperature controlled field probe
- Excellent results for peak jumping acquisitions
- Maximum sensitivity in all applications
- Fully controlled by the control software allowing rapid peak jumping between masses while maintaining maximum sensitivity

Electrostatic Analyzer

The HELIX SFT low mass collector includes a 5 cm 90 degree energy filter which, enables the system to measure extremely large ratios without the concern of peak tailing. The specification for this abundance sensitivity is <math><1\text{ ppb}</math> for adjacent masses (3 contribution from 4) at a pressure of 1×10^{-7} mbar. Note the individual partial pressures of other gases present, including Neon and Argon, must be less than 5% of that of the Helium.

Multiplier Performance Details

- Dynamic range: 1 CPS to 1,400,000 CPS
- Dark noise: <math><10\text{ CPM}</math> (0.2 CPM typical)
- Stability: <math><0.2\%</math> drift per hour at 300 KCPS

Vacuum System

The vacuum system is designed for true UHV performance. The system, including the flight tube, is manufactured from a range of advanced materials. These new materials, in conjunction with limited welding and new high specification heat treating and cleaning processes lead to ultra low background and rates of static rise.

The UHV pumping is achieved by utilizing a 40 L/s ion pump designed specifically for pumping noble gases and a 80 L/s turbo molecular pump backed by a two stage diaphragm pump. The pumping system isolation valve is an automated DN 40 all metal valve that is pneumatically controlled from the Qtegra software. The CF16 inlet valve to the mass spectrometer is manually controlled. The mass spectrometer also includes one SAES NP10 non-evaporable getter pump located in its own water cooled jacket. The getter can be isolated from the system via a CF16 all metal valve.

- Vacuum $\sim 10^{-10}$ mbar
- Dry-pumped backing line
- Ion gauge for vacuum monitoring
- Optional pneumatic / manual valves have helium leak rates for valve and body $< 1 \times 10^{-10}$ cc STP/sec
- Heaters and controls to bake mass spectrometer to $> 300^\circ\text{C}$ included

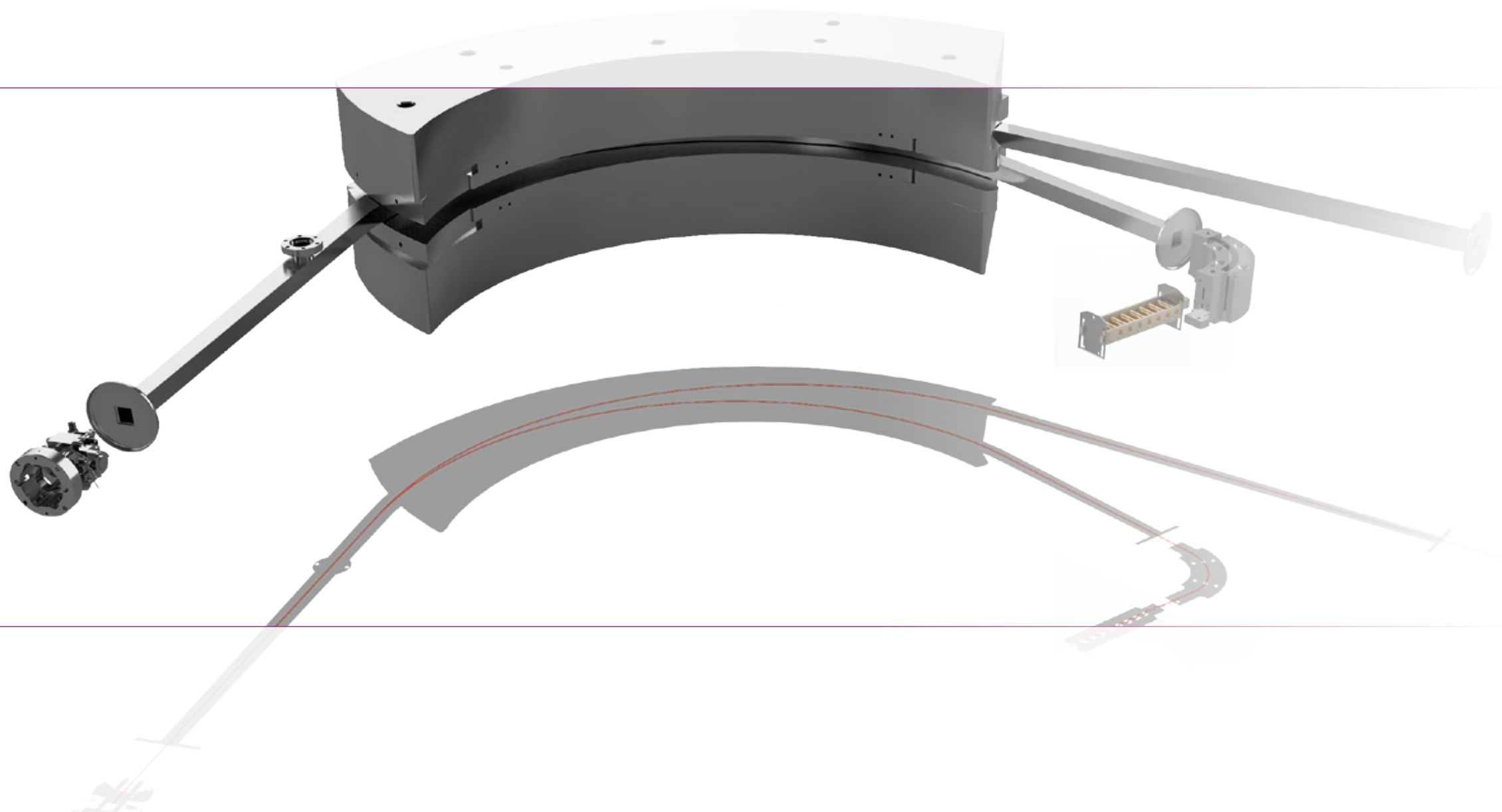

Control

Electronic Control Systems

The HELIX SFT mass spectrometer is driven by a state-of-the-art suite of electronics derived from the industry standard Thermo Scientific TRITON™ and MAT 253™ systems. The source electronics are taken from the MAT 253 stable isotope mass spectrometer and the magnet, data acquisition and collector electronics come from the Thermo Scientific TRITON Plus thermal ionization mass spectrometer.

- Source electronics - All tuning parameters are computer controlled, interfacing to a suite of electronics that operate the HV, focus, electron volts, ion repeller, trap and X & Z steering
- Intelligent interface controls communication between the PC and the source, the magnet and all valve controls
- Optional I/O electronics for interfacing third party hardware
- High stability high gain amplifiers taken from the TRITON Plus TIMS system coupling 50 volt dynamic ranges to 10^{10} , 10^{11} or 10^{12} gain amplification

Qtegra Software

The Thermo Scientific Qtegra™ Intelligent Scientific Data Solution™ is the dedicated data acquisition and control software utilized to control the HELIX SFT system. Operating under Windows 7, and in conjunction with the embedded interface, this provides comprehensive system control, acquisition and reporting.

- Full computer control and storage of all source parameters
- Full display, including a numeric and graphical display of ion beams and pressure gauges and a graphical valve status display
- Full access to valve control when automatic sequences not in operation
- Ion beams and isotope ratio display during data acquisition to allow operator assessment of data quality during analysis
- All raw data stored



Performance

HELIX SFT Mass Spectrometer Summary

- The ability to measure both helium isotopes simultaneously. No peak jumping required. This also leads to reduced analysis time and greater productivity.
- Abundance sensitivity: Given the unique design of HELIX SFT instrument the contribution of mass 4 at mass 3 is < 1 ppb. In comparison the 5400 / MAP215 had a specification of 1 ppm of mass 40 at 39.
- Volume: The internal volume of the HELIX SFT system is ~1400 cc's.
- Resolution: The low mass detector, where the helium 3 is measured, has a resolution > 700, which ensures that the helium 3 is completely separated from its two interferences HD and H.
- 10^{10} / 10^{11} / 10^{12} amplifiers with 50 volt ranges enable majority of analysis to be carried out on long life Faraday detector.

Performance Specifications

Mass range	1 to 140 mass units
Background	$\geq 5 \times 10^{-14}$ cc STP at ^{36}Ar
Sensitivity	Helium $> 2 \times 10^{-4}$ Amps / Torr at a source emission < 1.2 mA Argon $> 1 \times 10^{-3}$ Amps / Torr at a source emission < 1 mA
Resolution	For Faraday detector resolution > 400 at 10% peak valley For Multiplier detector resolution > 700 at 10% peak valley
Peak side stability	Drift to be less than the equivalent of ± 50 ppm in mass over 30 minutes at ^{40}Ar
Rate of rise	$< 1 \times 10^{-12}$ cc STP/min of ^{40}Ar
Abundance sensitivity	< 1 ppb in 30 min. for adjacent masses (3 contribution from 4) at a pressure of 1×10^{-7} mbar. Note the individual partial pressures of other gases present, including neon and argon, must be less than 5% of that of the helium

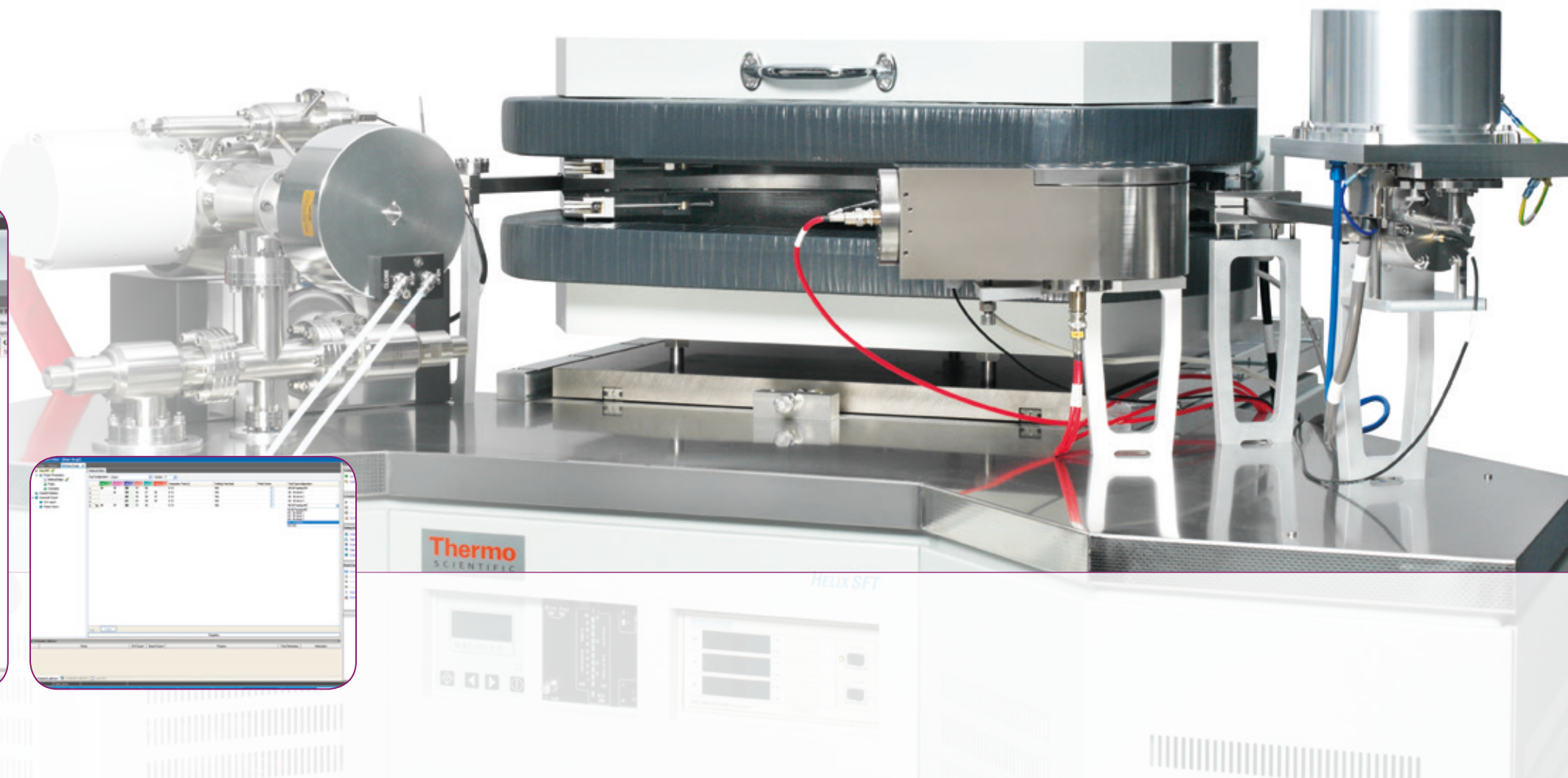
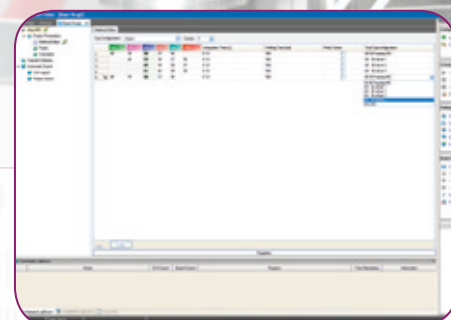
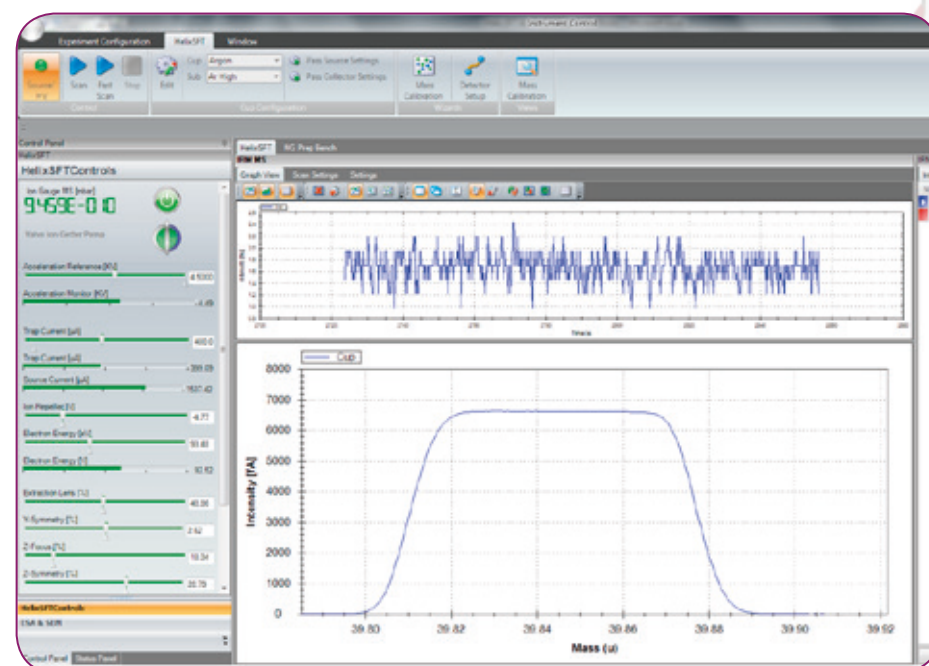

Automation

Rapid Sample Analysis

Preparation System

This prep line is used for all sample and reference gases prior to entry in the mass spectrometer. The line is equipped with two SAES NP10 getter pumps in jackets that can be water cooled, an ultra low volume micro ion gauge, 2 x spike / air reservoir and pipettes (pipette volumes are both 0.1 cc), liquid nitrogen cold trap, 20 L/s ion pump and a connection to the dry turbo molecular pumping system. Two spare ports, sealed by a CF16 vacuum blank flange, are provided to allow for future upgrades.

The two inlet lines enable sample gas to be cleaned prior to admission to the final clean up line. The two lines are pumped by 80 L/s molecular pump backed by a two stage diaphragm pump and are fitted with an NP10 getter pump in jackets that can be water cooled. The temperature of each getter can be controlled by its own electrical supply.

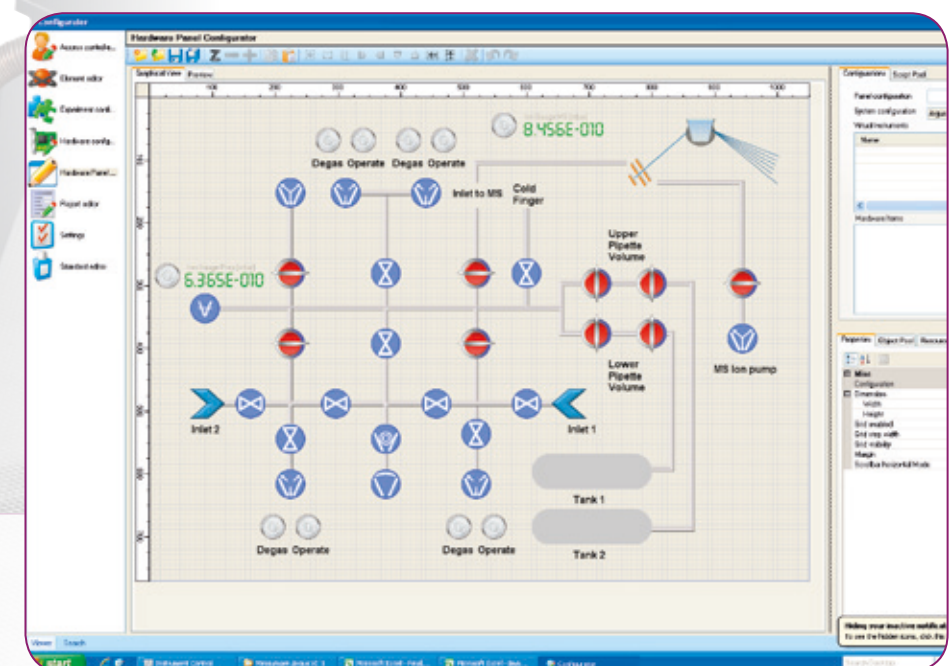
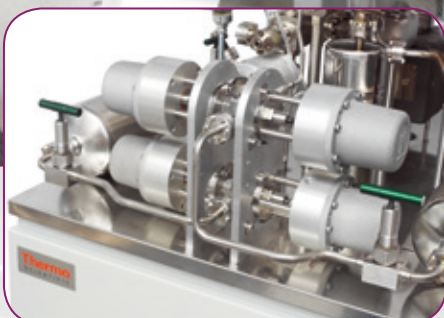
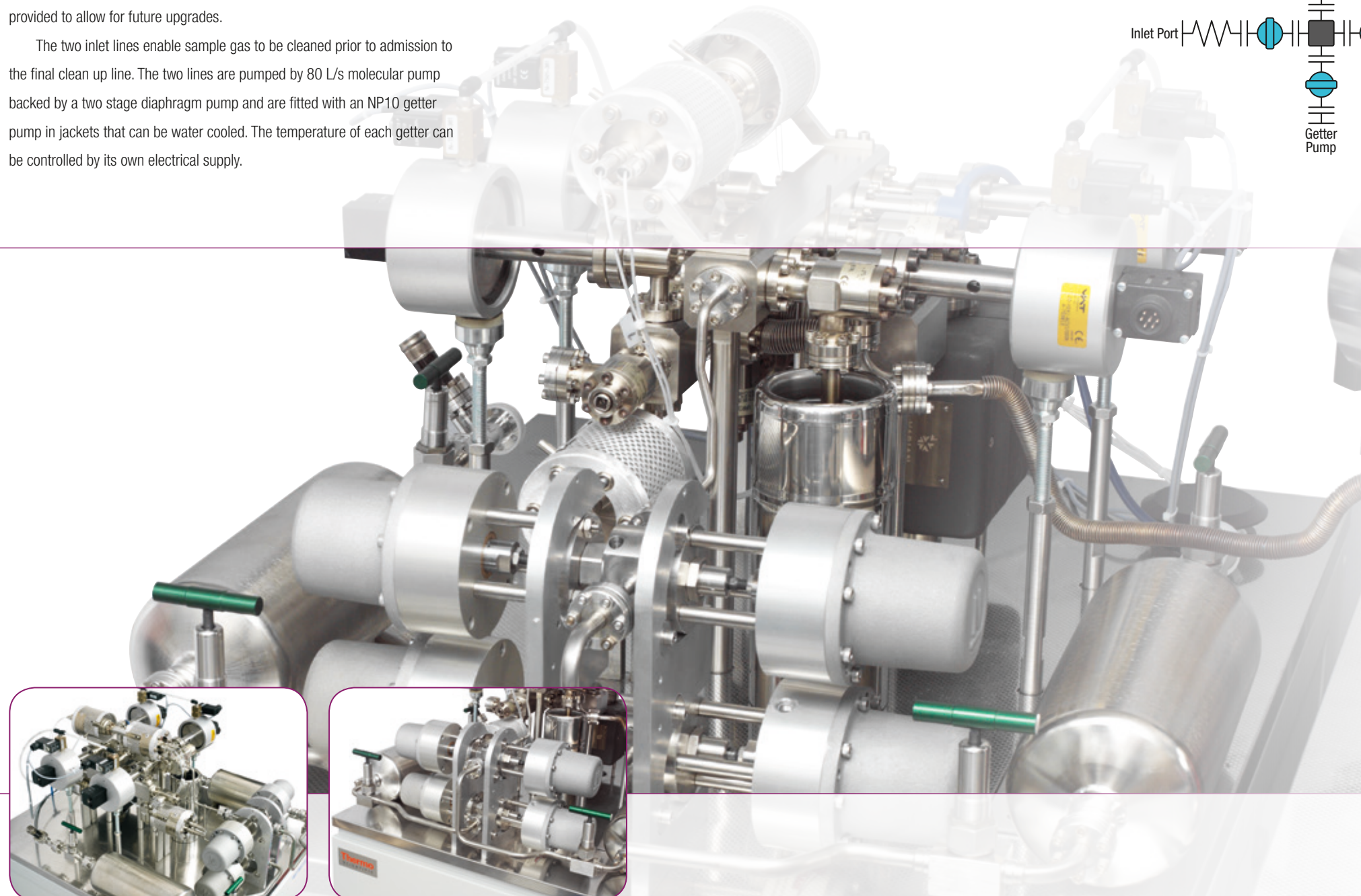
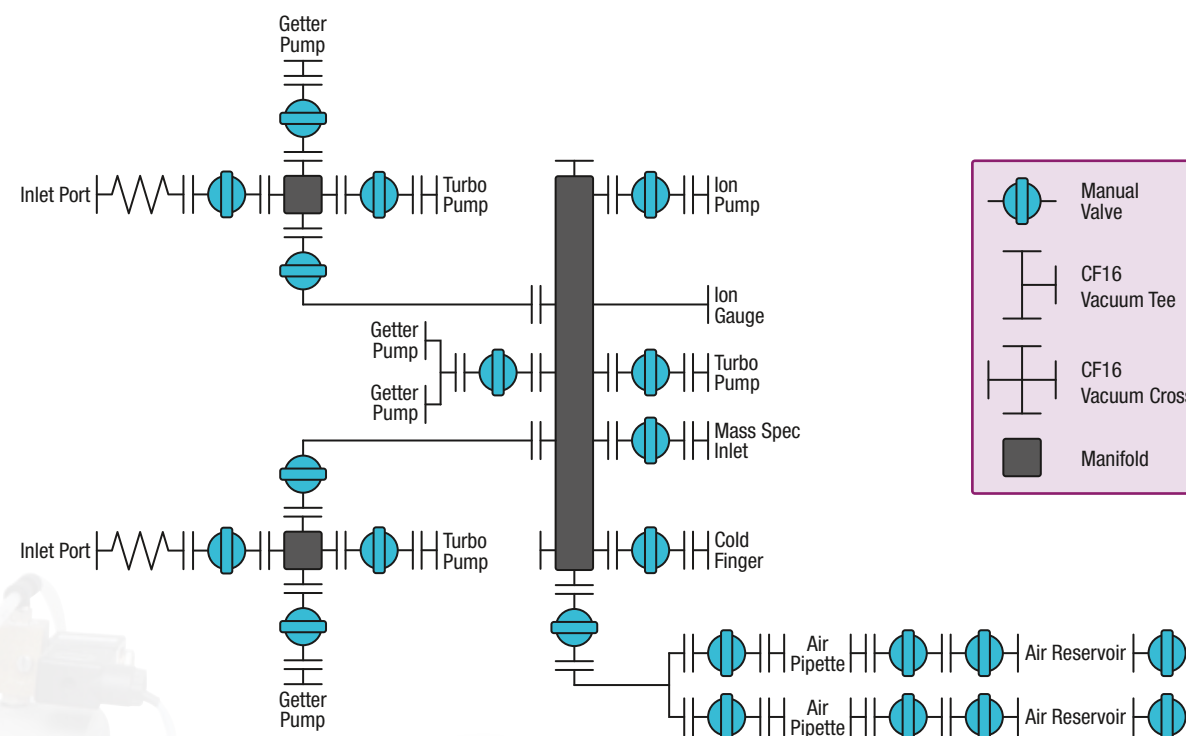

From Inner Earth to Outer Space

www.thermoscientific.com/geoscience



Noble Gas MS

Thermo Scientific ARGUS VI,
HELIX MC Plus and HELIX SFT



Thermal Ionization MS

Thermo Scientific TRITON Plus

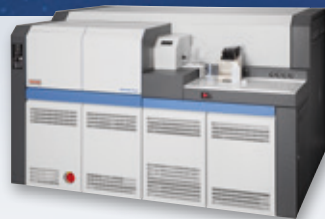

Multicollector ICP-MS

Thermo Scientific NEPTUNE Plus



ICP-MS

Thermo Scientific ELEMENT 2, ELEMENT XR and iCAP Q



Gas Isotope Ratio MS

Thermo Scientific MAT 253



Gas Isotope Ratio MS

Thermo Scientific DELTA V

REE

$^7\text{Li}/^6\text{Li}$

$^{176}\text{Hf}/^{177}\text{Hf}$

$^{29}\text{Si}/^{28}\text{Si}$

D/H

$^{18}\text{O}/^{16}\text{O}$

$^{143}\text{Nd}/^{144}\text{Nd}$

$^{34}\text{S}/^{32}\text{S}$

$^{13}\text{C}/^{12}\text{C}$

U-Th-Pb

$^{187}\text{Os}/^{188}\text{Os}$

$^{87}\text{Sr}/^{86}\text{Sr}$

Noble Gases

www.thermoscientific.com/HelixSFT

©2011, 2013 Thermo Fisher Scientific Inc. All rights reserved. Windows is a registered trademark of Microsoft Corporation. SAES is a trademark of SAES getters, Italy. ISO is a trademark of the International Standards Organisation. All other trademarks are the property of Thermo Fisher Scientific Inc. and its subsidiaries. * Specifications, terms and pricing are subject to change. Not all products are available in all countries. Please consult your local sales representative for details. * Selected patents in selected countries.

Thermo Fisher Scientific (Bremen) GmbH
Management System Registered to ISO 9001:2008

Africa-Other +27 11 570 1840
Australia +61 2 8844 9500
Austria +43 1 333 50 34 0
Belgium +32 53 73 42 41
Canada +1 800 530 8447
China +86 10 8419 3588
Denmark +45 70 23 62 60
Europe-Other +43 1 333 50 34 0

Finland /Norway/Sweden
+46 8 556 468 00
France +33 1 60 92 48 00
Germany +49 6103 408 1014
India +91 22 6742 9434
Italy +39 02 950 591
Japan +81 45 453 9100
Latin America +1 608 276 5659

Middle East +43 1 333 50 34 0
Netherlands +31 76 579 55 55
South Africa +27 11 570 1840
Spain +34 914 845 965
Switzerland +41 61 716 77 00
UK +44 1442 233555
USA +1 800 532 4752

Thermo
SCIENTIFIC

Part of Thermo Fisher Scientific